

# SURGICAL INSTRUMENTS

 [www.ranaaqeelsurgical.com](http://www.ranaaqeelsurgical.com)

 [info@ranaaqeelsurgical.com](mailto:info@ranaaqeelsurgical.com)



# Percussion Hammers & Aesthesiometers

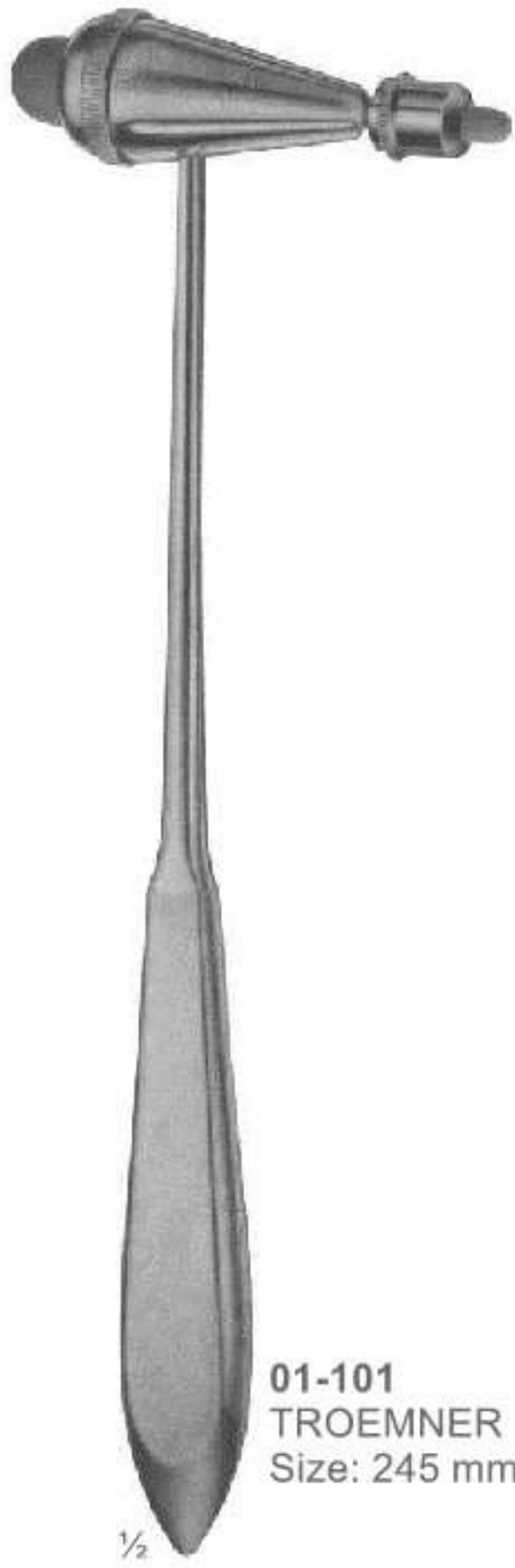

**01-101**  
TROEMNER  
Size: 245 mm

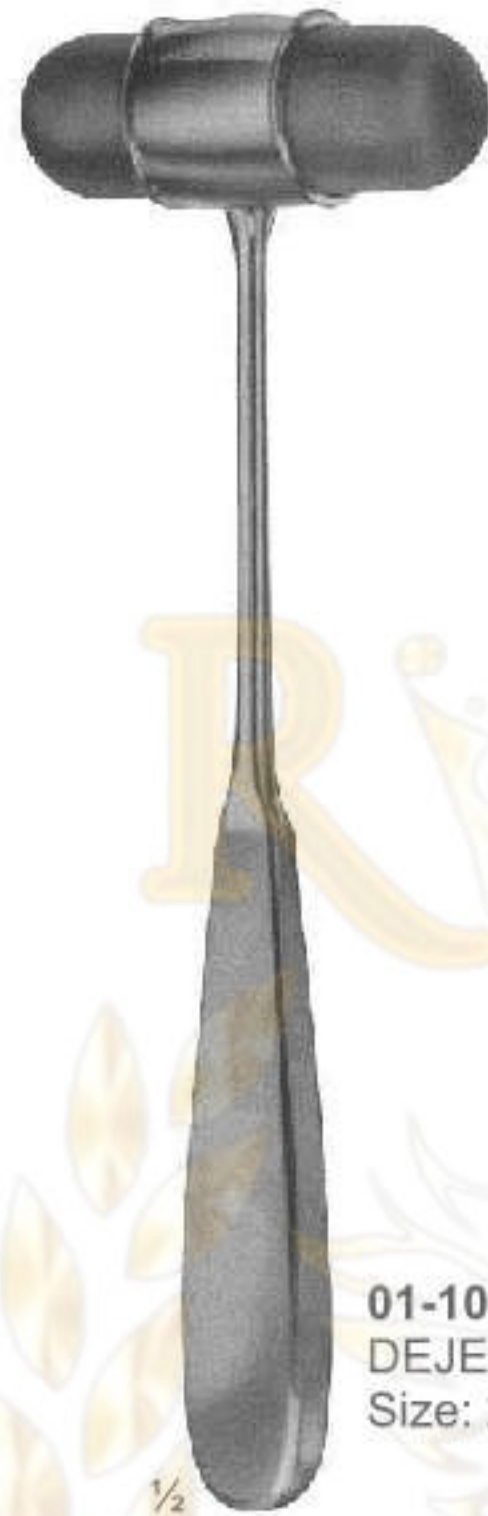

**01-102**  
DEJERINE  
Size: 200 mm

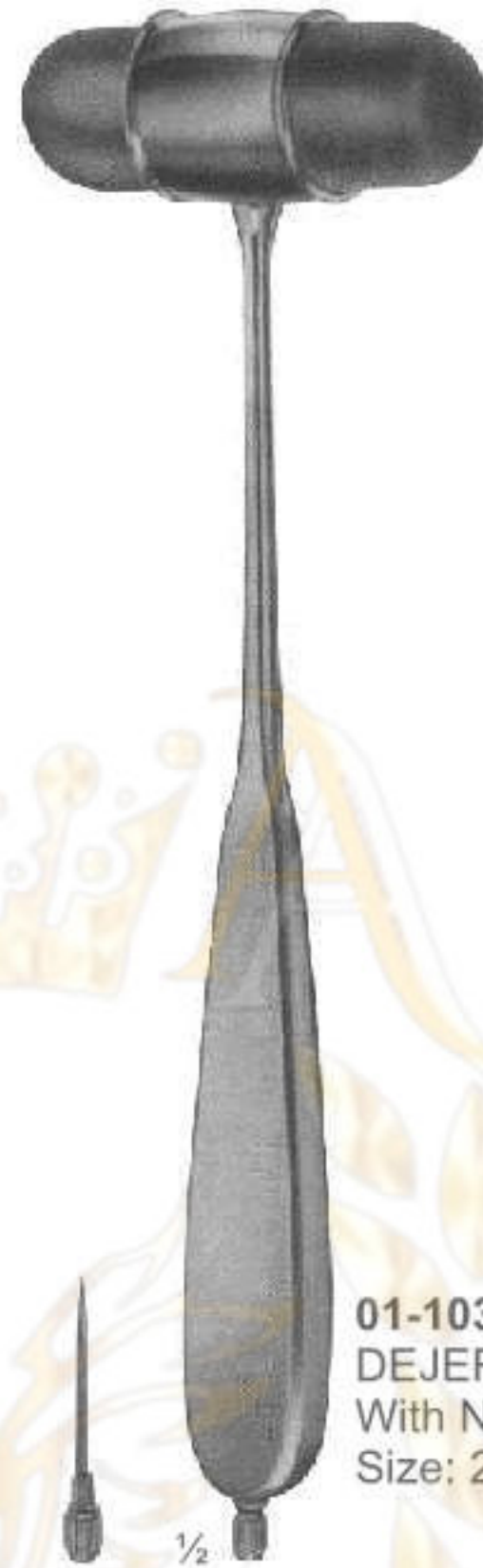

**01-103**  
DEJERINE  
With Needle  
Size: 210 mm



**01-104**  
TAYLOR  
Size: 195 mm



**01-105**  
BERLINER  
Size: 200 mm

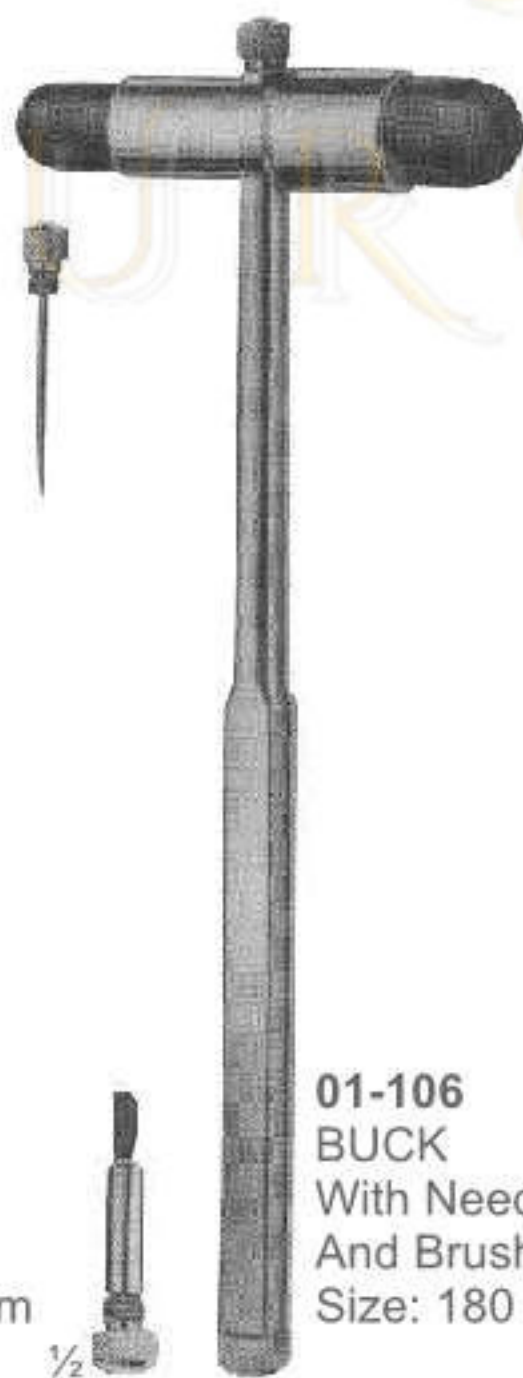

**01-106**  
BUCK  
With Needle  
And Brush  
Size: 180 mm



**01-107**  
RABINER  
With Needle  
And Brush  
Size: 255 mm



**01-108**  
ALY  
Size: 190 mm

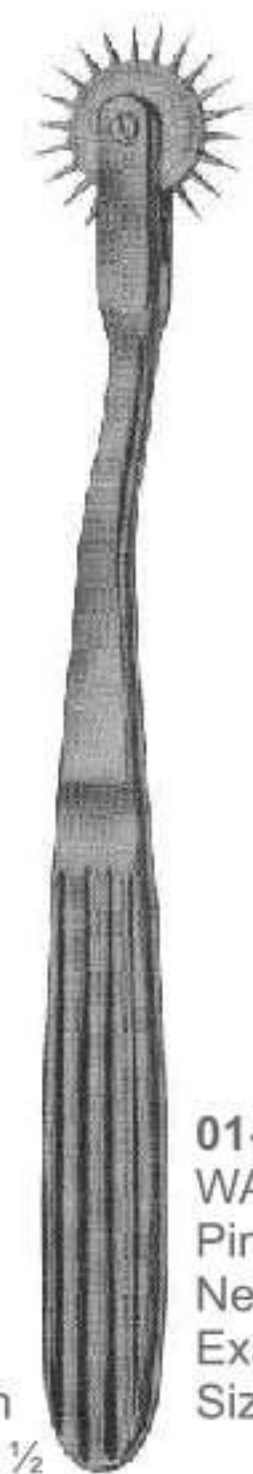

**01-109**  
WARTENBERG  
Pinwheel For  
Neurological  
Examination  
Size: 185 mm

# Stethoscopes

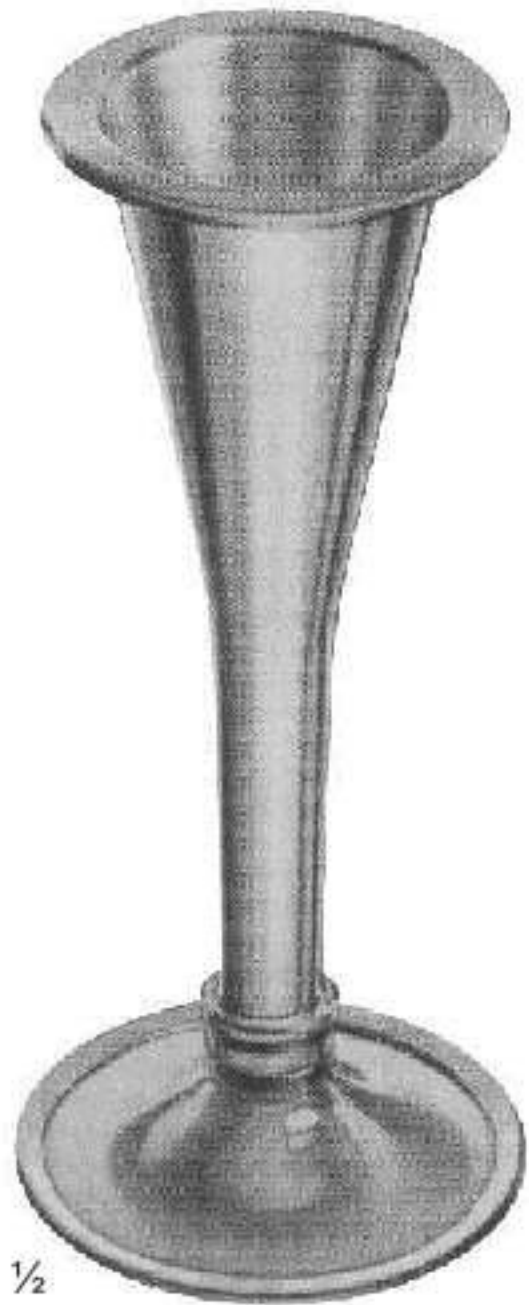

**01-110**  
PINARD (Aluminum)  
Size: 155 mm

1/2



**01-111**  
aus Holz (Wooden)  
Size: 145 mm

1/2



**01-112**  
BOWLES  
Stethoscope  
With Diaphragm

1/4



**01-113**  
ANESTOPHON

1/3



**01-114**  
FORD-BOWLES  
Duel Chest Piece  
With Two Outlets

1/4



**01-115**  
BOWLES

1/4

# Head Mirrors & Head Bands



**01-116**  
ZIEGLER  $\varnothing$  mm  
Head mirror only  
with rubber coating

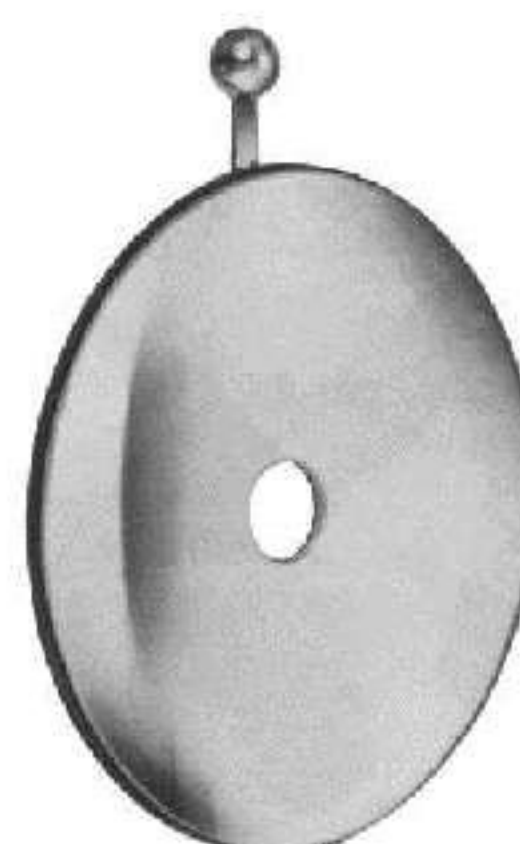

**01-117**  
ZIEGLER  $\varnothing$  mm  
Head mirror only  
with metal coating



**01-118**  
ZIEGLER  
Head band of plastic black



**01-120**  
MURPHY  
Head band of celluloid, white

**01-119**  
ZIEGLER  
Head band of plastic white

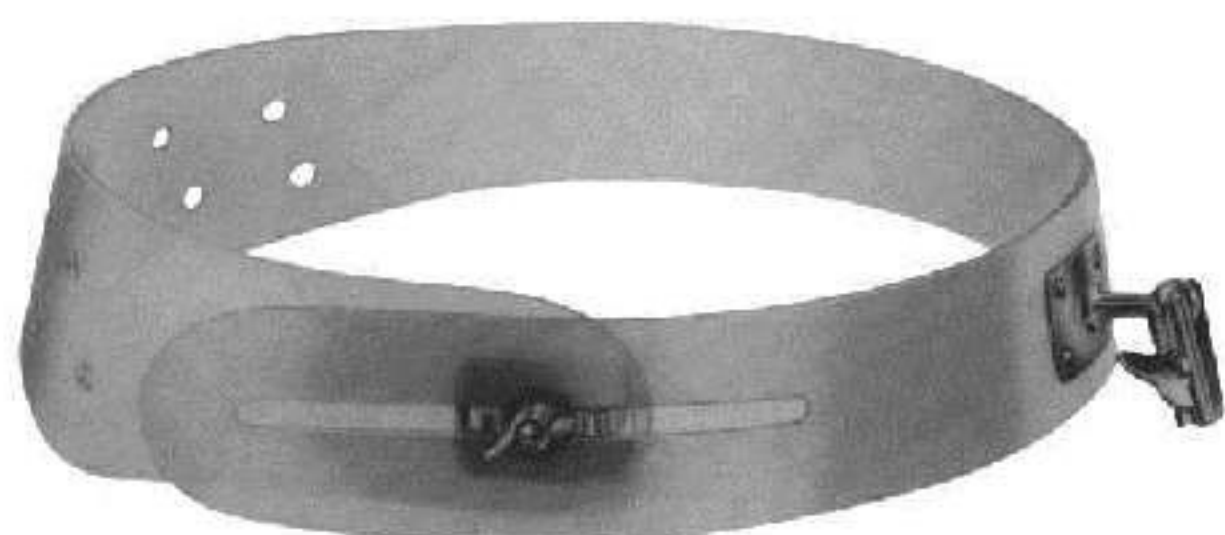

**01-121**  
Head band of plastic,  
white, soft pattern



**01-122**  
Head mirror with black  
plastic head band.

# Head Light



**01-123**

CLAR

Head light, 6 volt, with adjustable joint,  
white celluloid head band,  
cord with plugs for transformer

**01-124**

White celluloid head band, only, for

**01-125**

Spare mirror only, for

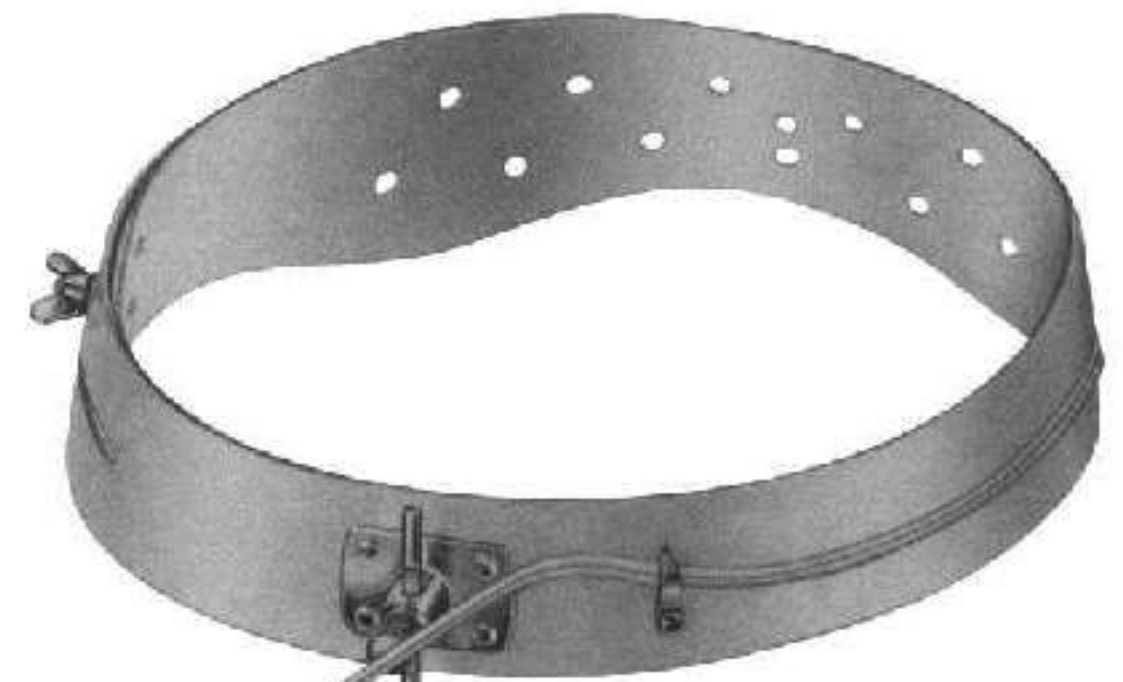

**01-126**  
spare bulb

**01-127**

CLAR

Head light, 6 volt, with adjustable joint,  
white celluloid head band, with foam rubber pad  
and cord with plugs for transformer

**01-128**

White celluloid head band, only, for head light

**01-129**

mirror only, for head light

spare foam rubber pad, for head band



**01-130**  
spare bulb

**01-131**

CLAR

Head light, 6 volt, with adjustable joint,  
white plastic head band,  
cord with plugs for transformer



**01-132**  
spare bulb

# Tongue Depressors

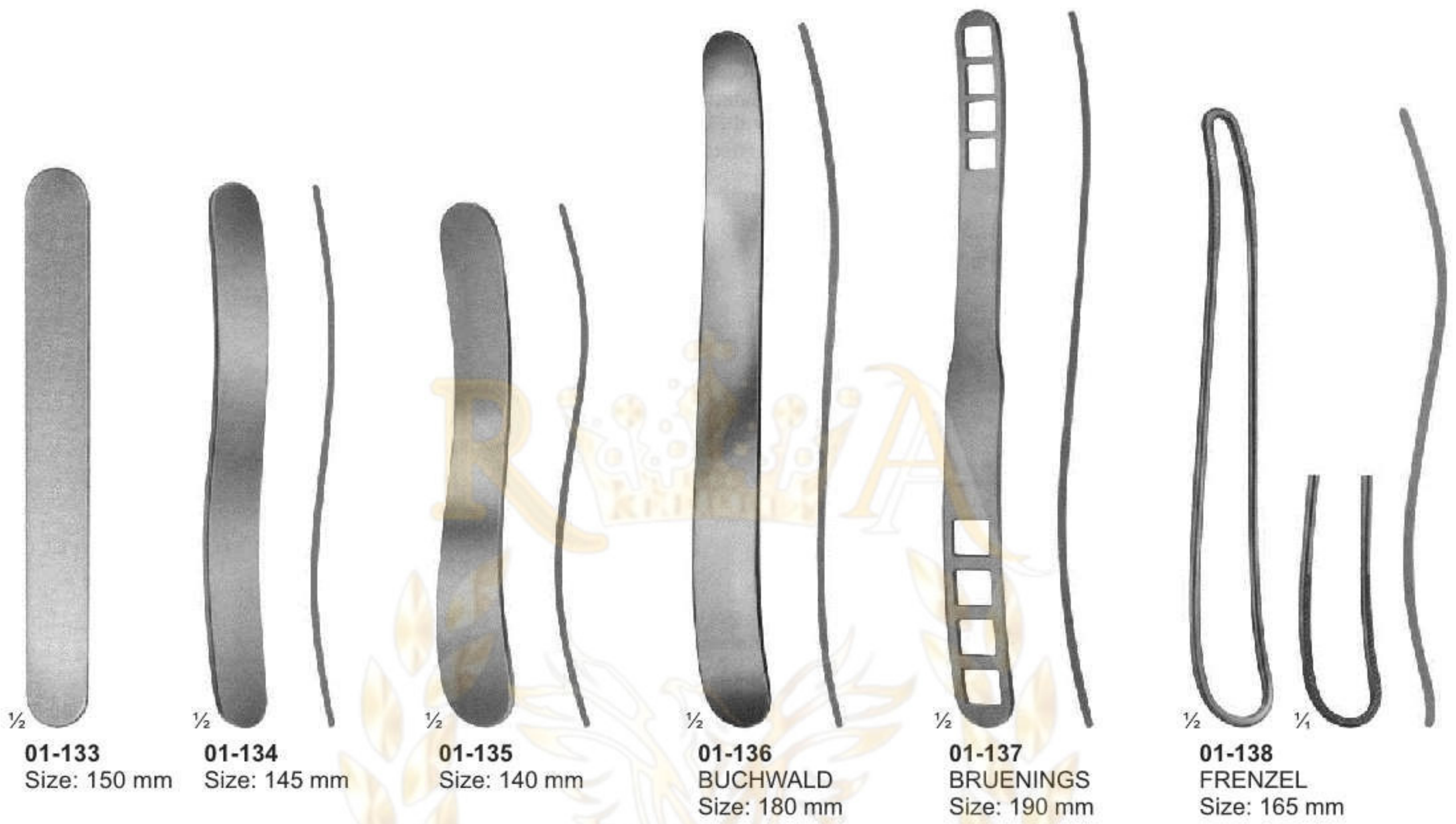

½  
**01-133**  
Size: 150 mm

½  
**01-134**  
Size: 145 mm

½  
**01-135**  
Size: 140 mm

½  
**01-136**  
BUCHWALD  
Size: 180 mm

½  
**01-137**  
BRUENINGS  
Size: 190 mm

½ ¼  
**01-138**  
FRENZEL  
Size: 165 mm

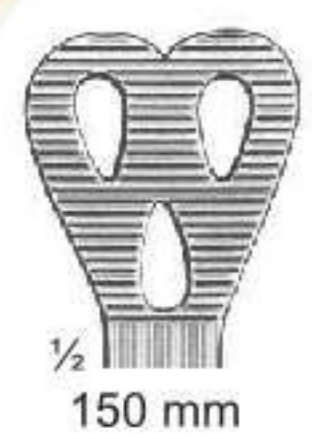

½  
150 mm



½  
140 mm

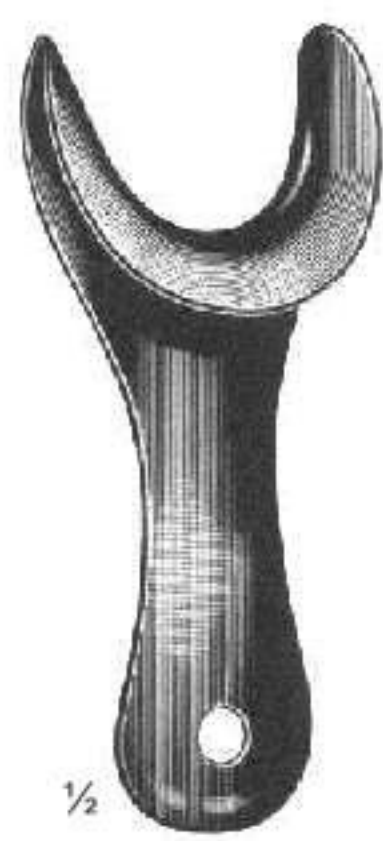

½  
**01-139**  
SIMPLEX  
Size: 110 mm



**01-140**  
STEMBERG  
Size: 120 mm, 140 mm, 160 mm

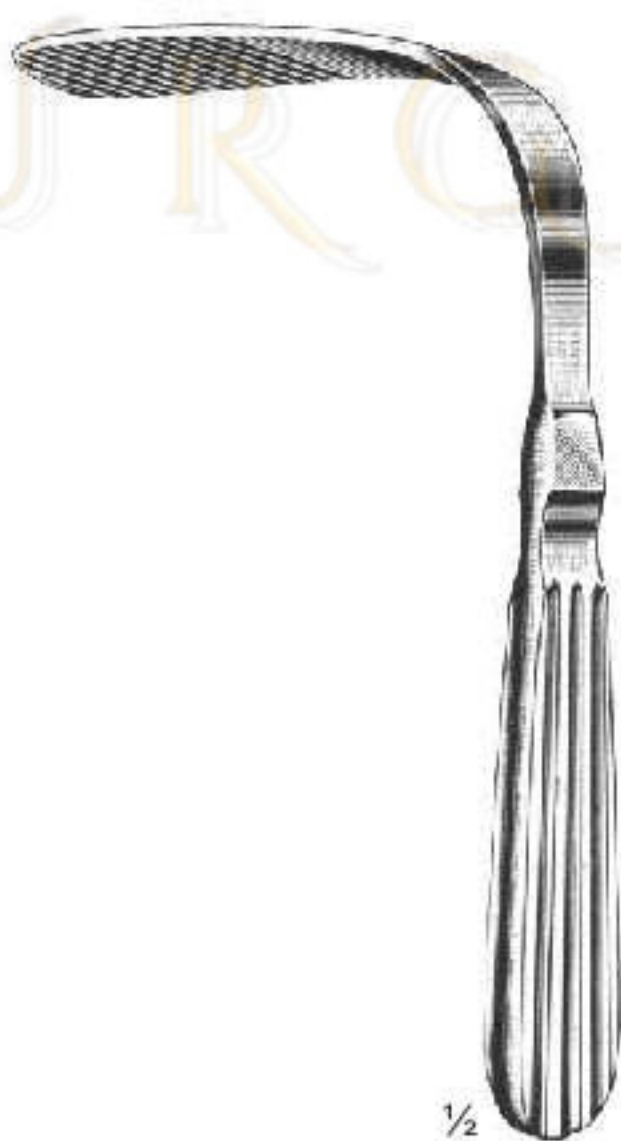

½  
**01-141**  
TOBOLD  
Size: 145 mm



½  
**01-142**  
ANDREW  
Size: 110 mm



½  
**01-143**  
WIEDER

# Tongue Depressors



1/2  
**01-144**  
SCHIMMELBUSCH  
Ether Mask



1/2  
**01-145**  
HEISTER  
Mouth Gag  
Size: 130 mm



1/2  
**01-146**  
FERGUSSON-ACKLAND  
Mouth Gag  
Size: 145 mm



1/2  
**01-147**  
DENHARDT  
Mouth Gag With Silicon  
Inserts, Interchangeable  
Size: 125 mm



1/2  
**01-148**  
ROSER KONIG  
Mouth Gag  
Size: 160 mm, 185 mm



1/2  
**01-149**  
YOUNG  
Size: 165 mm



1/4  
1 Pair Of  
Rubber Pads

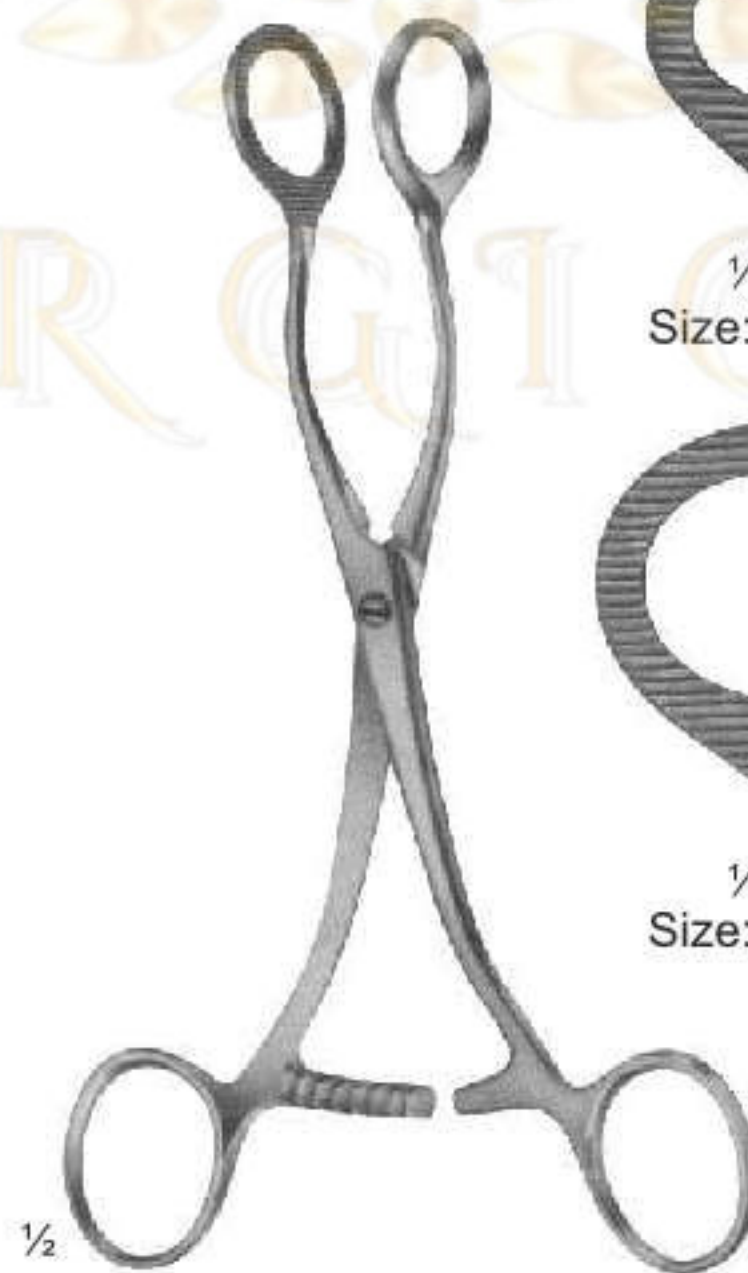

1/2  
**01-150**  
COLLIN  
Size: 160 mm, 170 mm



1/4  
Size: 160 mm



1/4  
Size: 170 mm

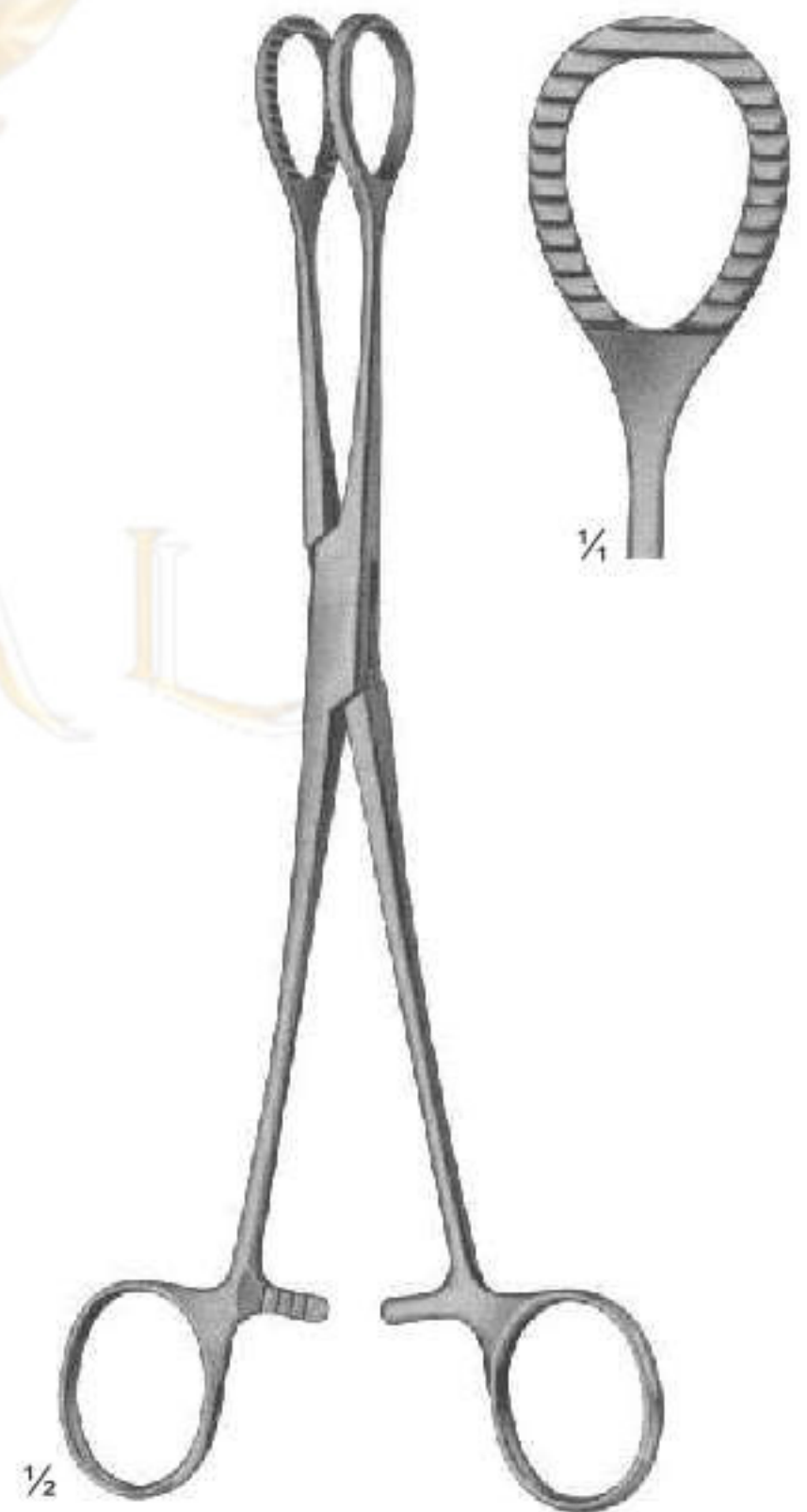

1/2  
**01-151**  
HEYWOOD-SMITH modif.  
Size: 215 mm

# Blood Lancets & Laryngeal Mirrors

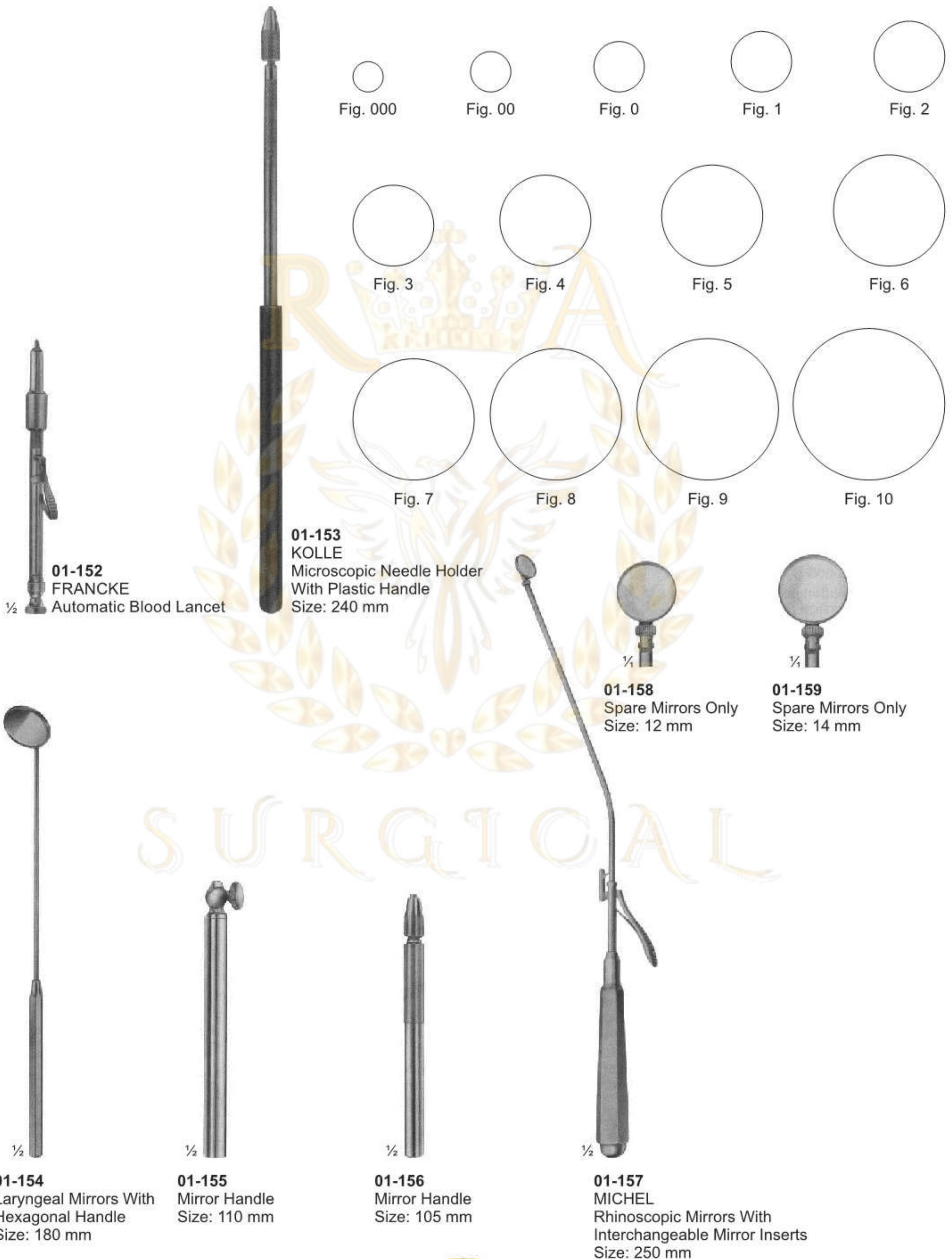

**01-152**  
FRANCKE  
Automatic Blood Lancet  
½

**01-153**  
KOLLE  
Microscopic Needle Holder  
With Plastic Handle  
Size: 240 mm

**01-158**  
Spare Mirrors Only  
Size: 12 mm  
¼

**01-159**  
Spare Mirrors Only  
Size: 14 mm  
¼

**01-154**  
Laryngeal Mirrors With  
Hexagonal Handle  
Size: 180 mm  
½

**01-155**  
Mirror Handle  
Size: 110 mm  
½

**01-156**  
Mirror Handle  
Size: 105 mm  
½

**01-157**  
MICHEL  
Rhinoscopic Mirrors With  
Interchangeable Mirror Inserts  
Size: 250 mm  
½



# Diagnostic Sets



1/2

**01-160 - 162**  
MAGILL



**01-160**  
Infants  
Size: 150 mm



**01-161**  
Children  
Size: 200 mm



**01-162**  
Adults  
Size: 250 mm



1/2

**01-163**  
Medium battery handle  
only, 25 mm diam.



**01-163-A**  
Spare bulb  
2.7 volt, for  
otoscopes



**01-163-B**  
Spare bulb  
2.6 volt, for  
ophthalmoscopes



**01-164**  
Otoscope Set, Consists Of  
Battery Handle Without Batteries,  
3 Ear Specula, 1 Bulb In Velvet Lined Case



**01-165**  
Diagnostic Set, Otoscope With Three Specula,  
Nasal Speculam, Lamp Holder, Two Laryngeal  
Mirrors, Tongue Blade Holder

# Diagnostic Sets



1/3

**01-166**  
**MILLER**  
 Laryngoscope Set, Consists Of Battery Handle ( Without Battery )  
 With Four Miller Laryngoscope Blades

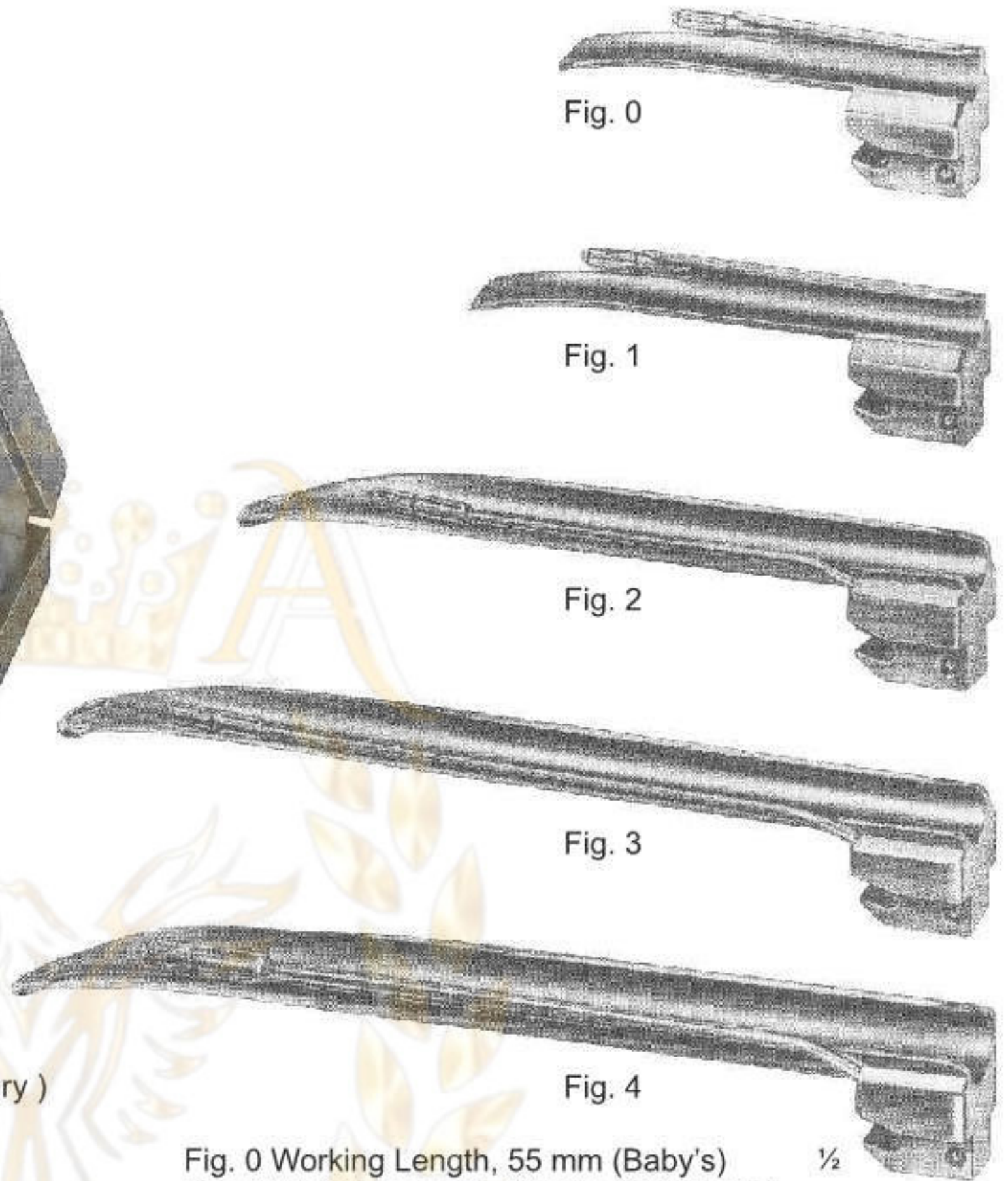

Fig. 0 Working Length, 55 mm (Baby's) 1/2  
 Fig. 1 Working Length, 80 mm (Children's)  
 Fig. 2 Working Length, 130 mm (Adolescent's)  
 Fig. 3 Working Length, 170 mm (Women's)  
 Fig. 4 Working Length, 180 mm (Men's)



1/3

**01-167**  
**GUEDEL-NEGUS**  
 Laryngoscope Set, Consists Of Battery Handle ( Without Battery )  
 With Four Miller Laryngoscope Blades

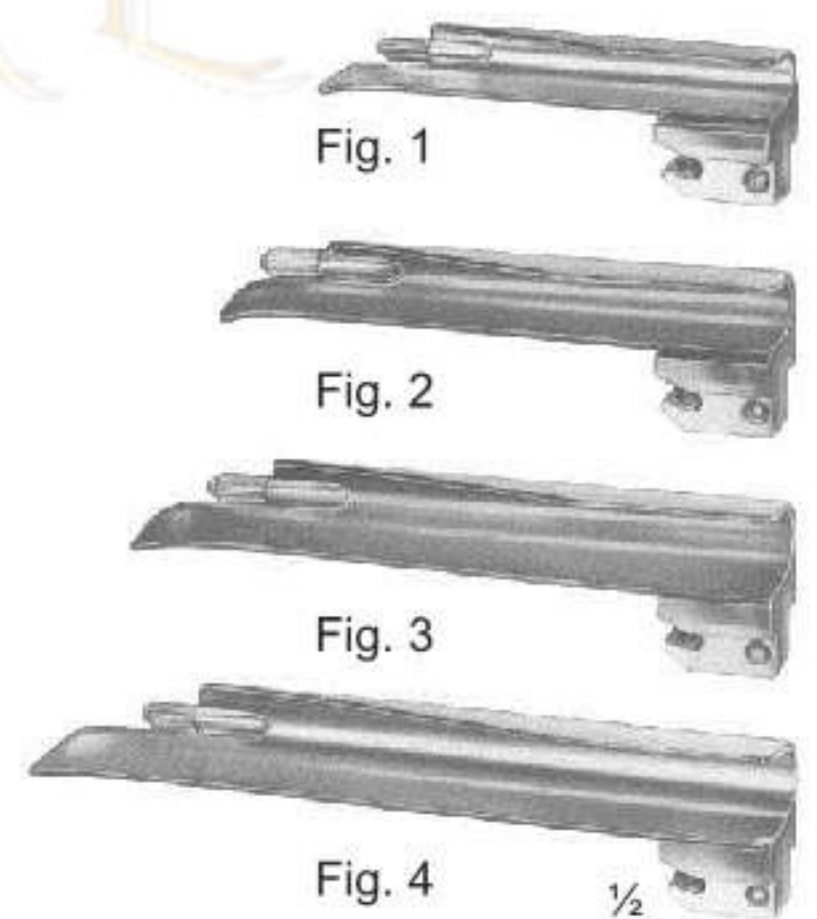

Fig. 1 Working Length, 70 mm (Children's)  
 Fig. 2 Working Length, 90 mm (Adolescent's)  
 Fig. 3 Working Length, 110 mm (Women's)  
 Fig. 4 Working Length, 135 mm (Men's)

# Diagnostic Sets



1/3

**01-168**  
McIntosh  
Laryngoscope Set, Consists Of Battery Handle ( Without Battery )  
With Three McIntosh Blades, Fig. 1, Fig. 2, Fig. 3

**01-169**  
McIntosh  
Laryngoscope Set, Consists Of Battery Handle ( Without Battery )  
With Five McIntosh Blades, Fig. 1, Fig. 2, Fig. 3, Fig. 4, Fig. 5



Fig. 0



Fig. 1



Fig. 2

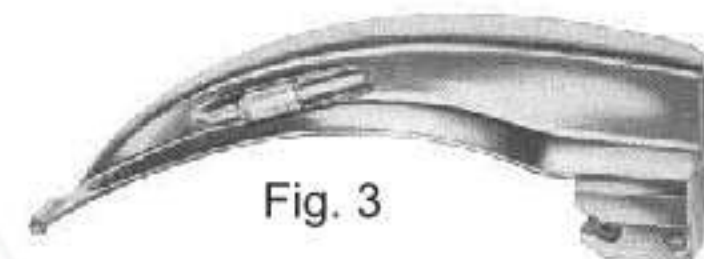

Fig. 3

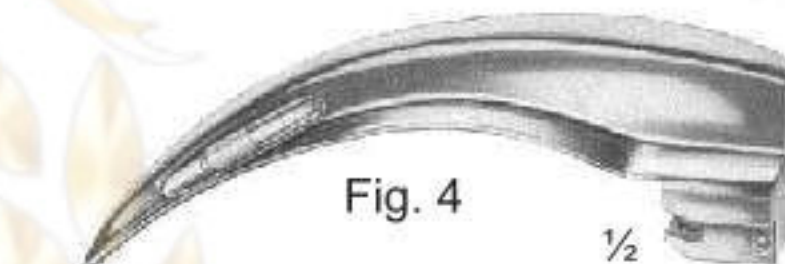

Fig. 4

1/2

Fig. 0 Working Length, 55 mm (Baby's)  
Fig. 1 Working Length, 75 mm (Children's)  
Fig. 2 Working Length, 90 mm (Adolescent's)  
Fig. 3 Working Length, 110 mm (Women's)  
Fig. 4 Working Length, 135 mm (Men's)

**01-170**  
FOREGGER  
Laryngoscope Set, Consists Of  
Battery Handle ( Without Battery )  
With Three Foregger Blades,  
Fig. 1, Fig. 2, Fig. 3,



1/3

**01-171**  
FOREGGER  
Laryngoscope Set, Consists Of  
Battery Handle ( Without Battery )  
With Five Foregger Blades,  
Fig. 1, Fig. 2, Fig. 3, Fig. 4, Fig. 5



Fig. 1



Fig. 2



Fig. 3



Fig. 4

1/2

Fig. 1 Working Length, 70 mm (Children's)  
Fig. 2 Working Length, 90 mm (Adolescent's)  
Fig. 3 Working Length, 110 mm (Women's)  
Fig. 4 Working Length, 135 mm (Men's)



1/2

**01-172**  
Fiber Optic  
Battery Handle



1/2

**01-173**  
Fiber Optic  
Battery Handle



1/4

**01-174**  
Replacement Lamp  
( Krypton ) 2.5 V



1/4

**01-175**  
Replacement Lamp  
( Halogen ) 2.5 V

# Examination & Measuring Instruments

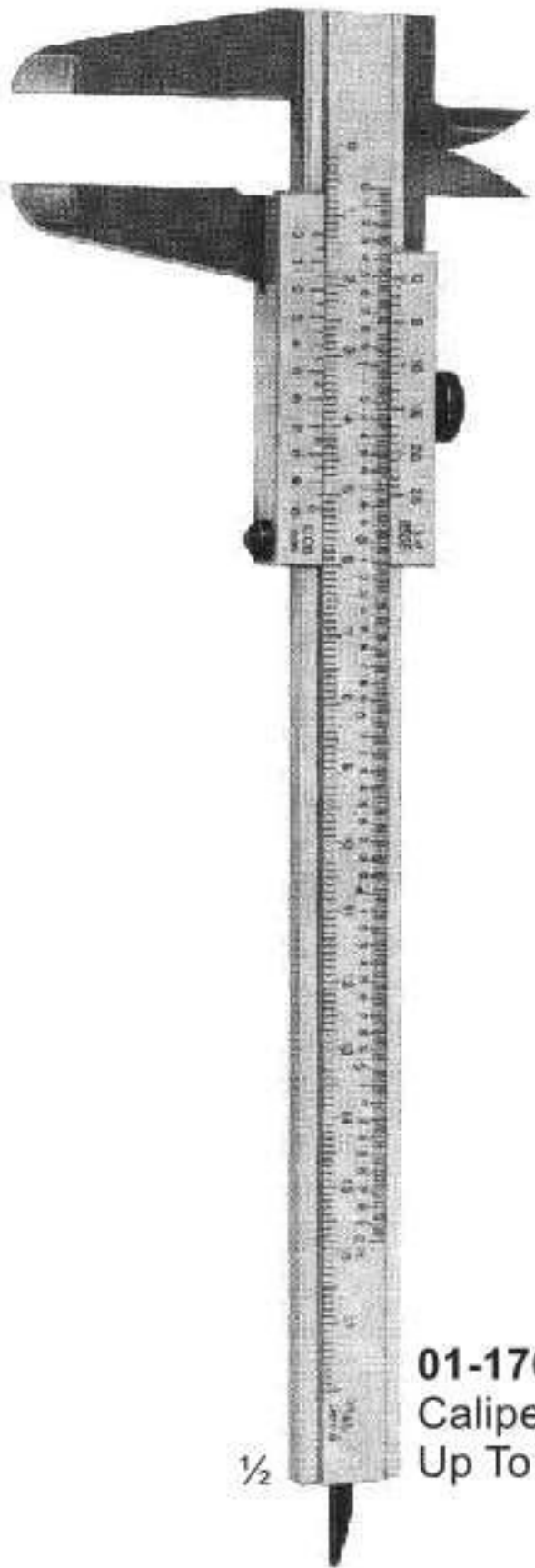

**01-176**  
Caliper Of Aluminum  
Up To 180 mm



**01-177**  
VERNIER  
Universal Caliper Of Steel  
Up To 120 mm

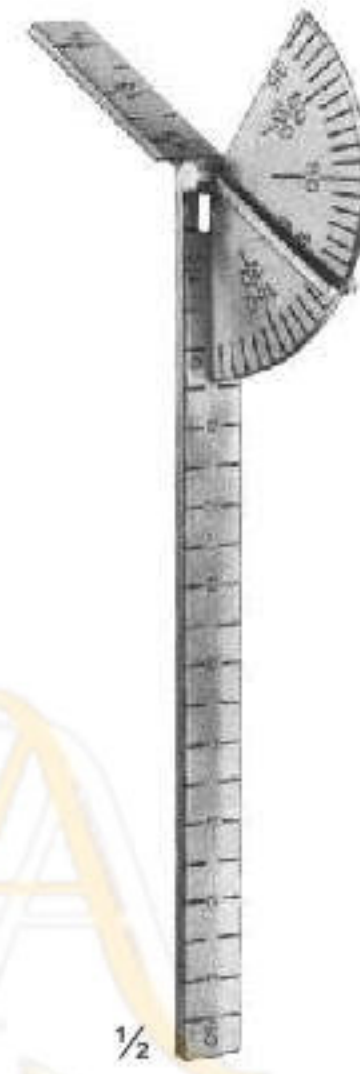

**01-178**  
CAROLL  
Size: 140 mm



**01-179**  
TOWNLEY  
Size: 100 mm

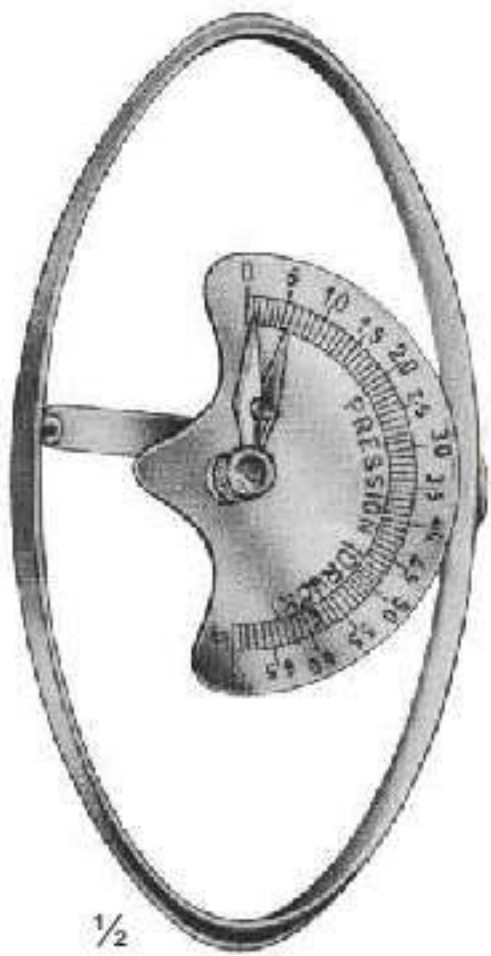

**01-180**  
COLLIN  
Druck Pressure 72 kg  
Size: 125 mm



**01-181**  
BERTILLON  
Caliper For Measuring The Head  
Size: 320 mm



**01-182**  
CASTROVIEJO  
Caliper

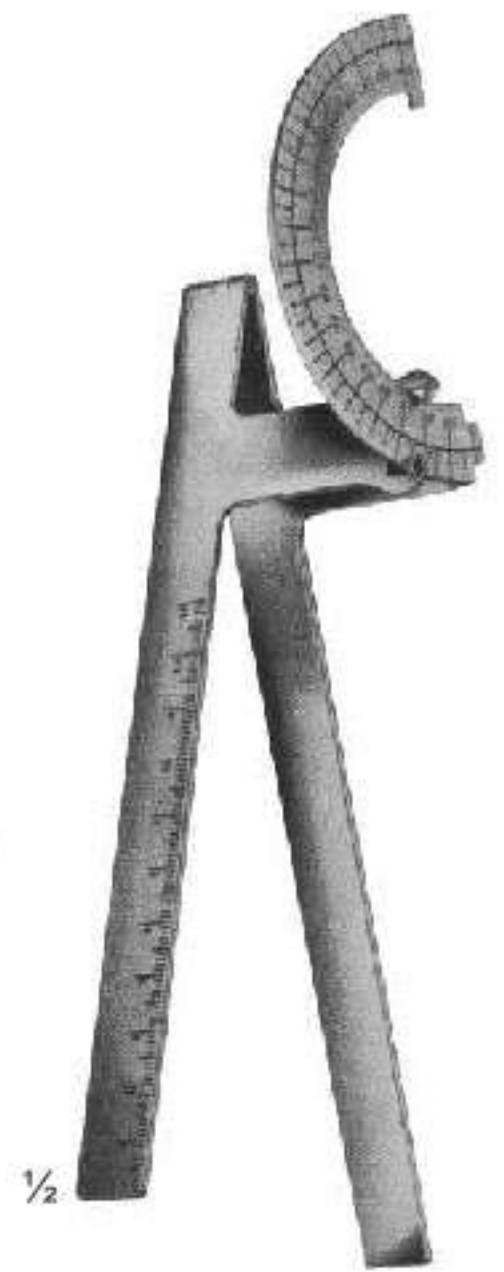

**01-183**  
MOLTGEN  
Goniometer



**01-185**  
Size: 150 mm

**01-184**  
Size: 500 mm

# Dissecting Knives



02-101 - 110  
Fig. 1 - 10



02-101  
Fig. 1



02-102  
Fig. 2



02-103  
Fig. 3



02-104  
Fig. 4



02-105  
Fig. 5



02-106  
Fig. 6



02-107  
Fig. 7



02-108  
Fig. 8



02-109  
Fig. 9



02-110  
Fig. 10

# Autopsy & Cartilage Knives



# Scalpels, Tenotomes & Resection Knives



# Scalpels, Tenotomes



¼

02-130

02-131

02-132

02-133

02-134

02-135

02-136

02-137

02-138

02-139

¼

02-130 - 149  
Size: 140 mm - 175 mm

¼

02-140

02-141

02-142

02-143

02-144

02-145

02-146

02-147

02-148

02-149  
Tenotome



# Amputating Knives, Cartilage Knives, Autopsy Knives



- 02-150**  
Size: 130 mm

**02-151**  
Size: 160 mm

**02-152**  
Size: 190 mm

**02-153**  
Size: 200 mm
- 02-154**  
CATLIN  
Size: 160 mm  
Blade Length  
Amputating  
Knives
- 02-155**  
LANGENBECK  
Size: 120 mm  
Blade Length  
Flap Knives
- 02-156**  
Size: 110 mm  
Blade Length  
Interosseous  
Knives
- 02-157**  
Size: 55 mm  
Blade Length  
With Raspatory,  
Wooden Handle
- 02-158**  
Size: 70 mm  
Blade Length  
Wooden Handle
- 02-159**  
Size: 80 mm  
Blade Length  
Metal Handle
- 02-160**  
Size: 195 mm  
Blade Length  
Metal Handle

Blade Length  
Amputating Knives

# Cone Knives, Myomatome, Trigeminal & Tonsil Knives



**02-161**  
AYRE  
Size: 235 mm  
Cone Knife

**02-162**  
Size: 230 mm  
Cone Knife

**02-163**  
SEGOND  
Size: 270 mm  
Myomatome

**02-164**  
OLIVECRONA  
Size: 205 mm  
Trigeminal  
Knife

**02-165**  
Size: 230 mm  
Trigeminal  
Knife

**02-166**  
FOWLER  
Size: 200 mm  
Tonsil Knife

**02-167**  
ABRAHAM  
Size: 215 mm  
Tonsil Knife

**02-168**  
BRUNINGS  
Size: 215 mm  
Tonsil Knife

# Scalpels, Dura Knives & Comedone Extractors



**02-169 - 170**  
JOSEPH  
Size: 145 mm  
Double Edged  
Nasal Knives, Pointed



**02-169**  
Straight



**02-170**  
Curved



**02-171 - 173**  
ZIEGLER  
Size: 120 mm  
Milium Knives



**02-171**  
Small



**02-172**  
Large



**02-173**  
Pointed



**02-174**  
VIDAL  
Lupus Scraper  
Size: 135 mm

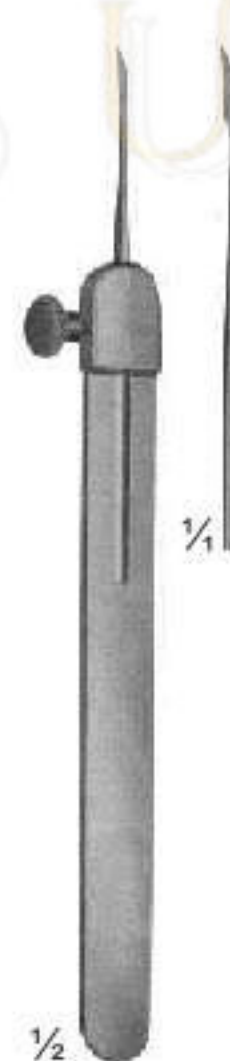

**02-175**  
MONCORPS  
Milium Knives  
Size: 130 mm



**02-176**  
SAALFELD  
Size: 100 mm

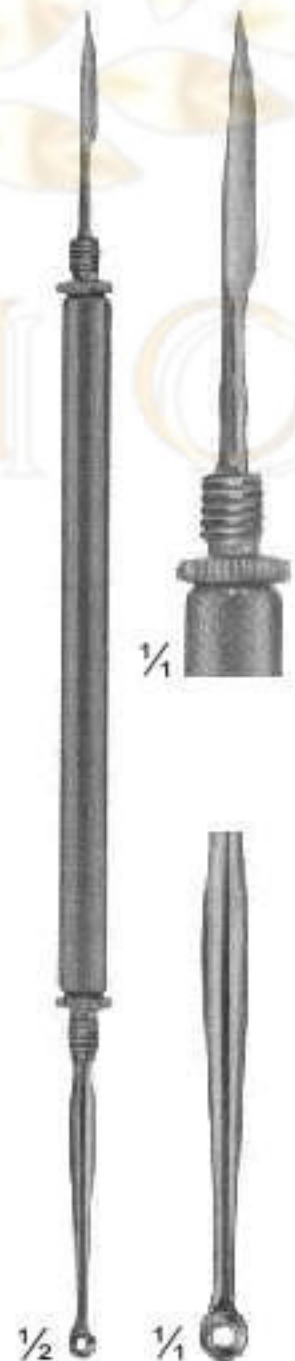

**02-177**  
HEBRA  
Size: 180 mm



**02-178**  
Size: 145 mm



**02-179**  
UNNA  
Size: 145 mm

# Razor Blade Holders & Breakers



**02-180**  
TROUTMAN-CHRIS  
Size: 100 mm



**02-181**  
TROUTMAN-CHRIS  
Size: 100 mm



**02-182**  
Size: 110 mm



**02-183**  
CASTROVIEJO  
Size: 130 mm



**02-184**  
Size: 185 mm

# Scalpel Handles



**02-185**  
STANDARD  
No. 4  
Solid

**02-186**  
Double Handel  
No. 4 + No. 3  
Solid

**02-187**  
No. 4 L  
Straight  
Solid

**02-188**  
No. 4 L  
Solid Angled

**02-189**  
COLLIN  
No. 8  
Hollow

**02-190**  
COLLIN  
No. 9  
Hollow

**02-191**  
Plastic

# Scalpel Handles



<b>02-192</b> STANDARD No. 3 Solid	<b>02-193</b> No. 3 Solid	<b>02-194</b> No. 3 Solid	<b>02-195</b> No. 3 L Straight Solid	<b>02-196</b> No. 3 L Angled Solid	<b>02-197</b> No. 7 Solid	<b>02-198</b> No. 7 K Solid	<b>02-199</b> Hollow-Round	<b>02-200</b> No. 3 Straight Solid	<b>02-201</b> No. 3 Angled Solid
---	---------------------------------	---------------------------------	---	---	---------------------------------	-----------------------------------	-------------------------------	---	---

# Micro Scissors, "Spring Type" Flat Handles

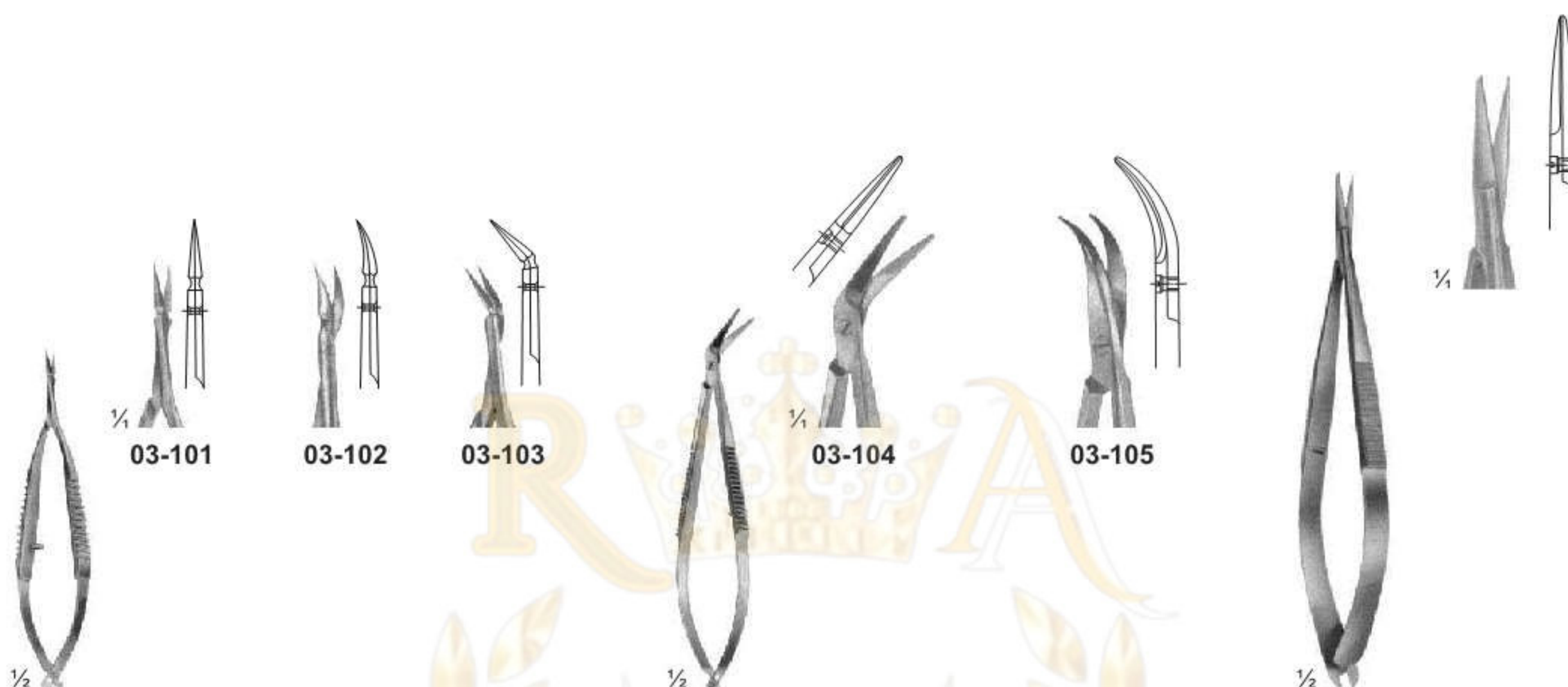

**03-101 - 103**  
VANNAS  
Size: 85 mm

**03-104 - 105**  
CASTROVIEJO  
Size: 95 mm

**03-106**  
NOYES  
Size: 125 mm



**03-107 - 108**  
WECKER  
Eye Scissor  
Size: 110 mm

**03-109**  
CASTROVIEJO  
Eye Scissor  
Size: 115 mm

**03-110 - 111**  
CASTROVIEJO  
Eye Scissor  
Size: 110 mm

# Micro Scissors, "Spring Type" Flat Handles



**03-101 - 103**  
VANNAS  
Size: 85 mm

**03-104 - 105**  
CASTROVIEJO  
Size: 95 mm

**03-106**  
NOYES  
Size: 125 mm



**03-107 - 108**  
WECKER  
Eye Scissor  
Size: 110 mm

**03-109**  
CASTROVIEJO  
Eye Scissor  
Size: 115 mm

**03-110 - 111**  
CASTROVIEJO  
Eye Scissor  
Size: 110 mm



# Micro Scissors, "Spring Type" Flat Handles

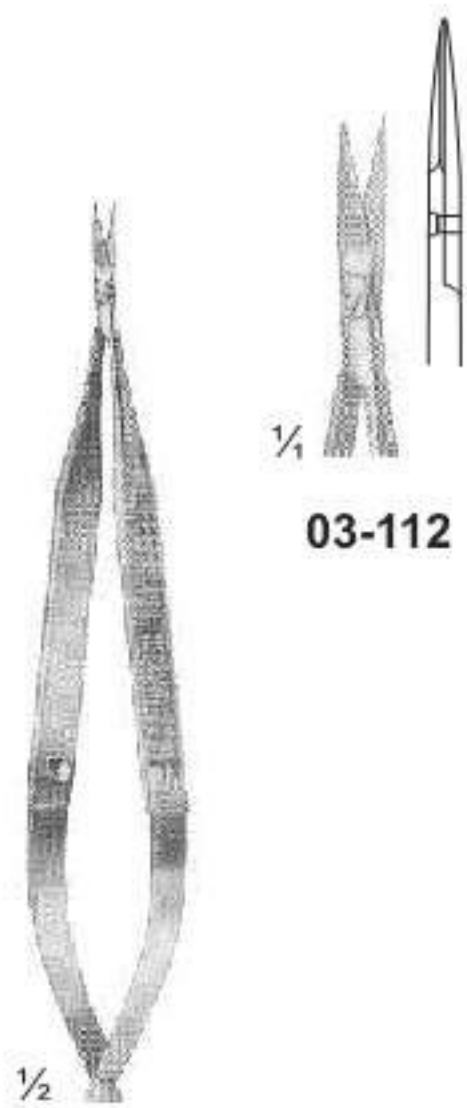

03-112  
03-113

03-112 - 113  
Size: 120 mm

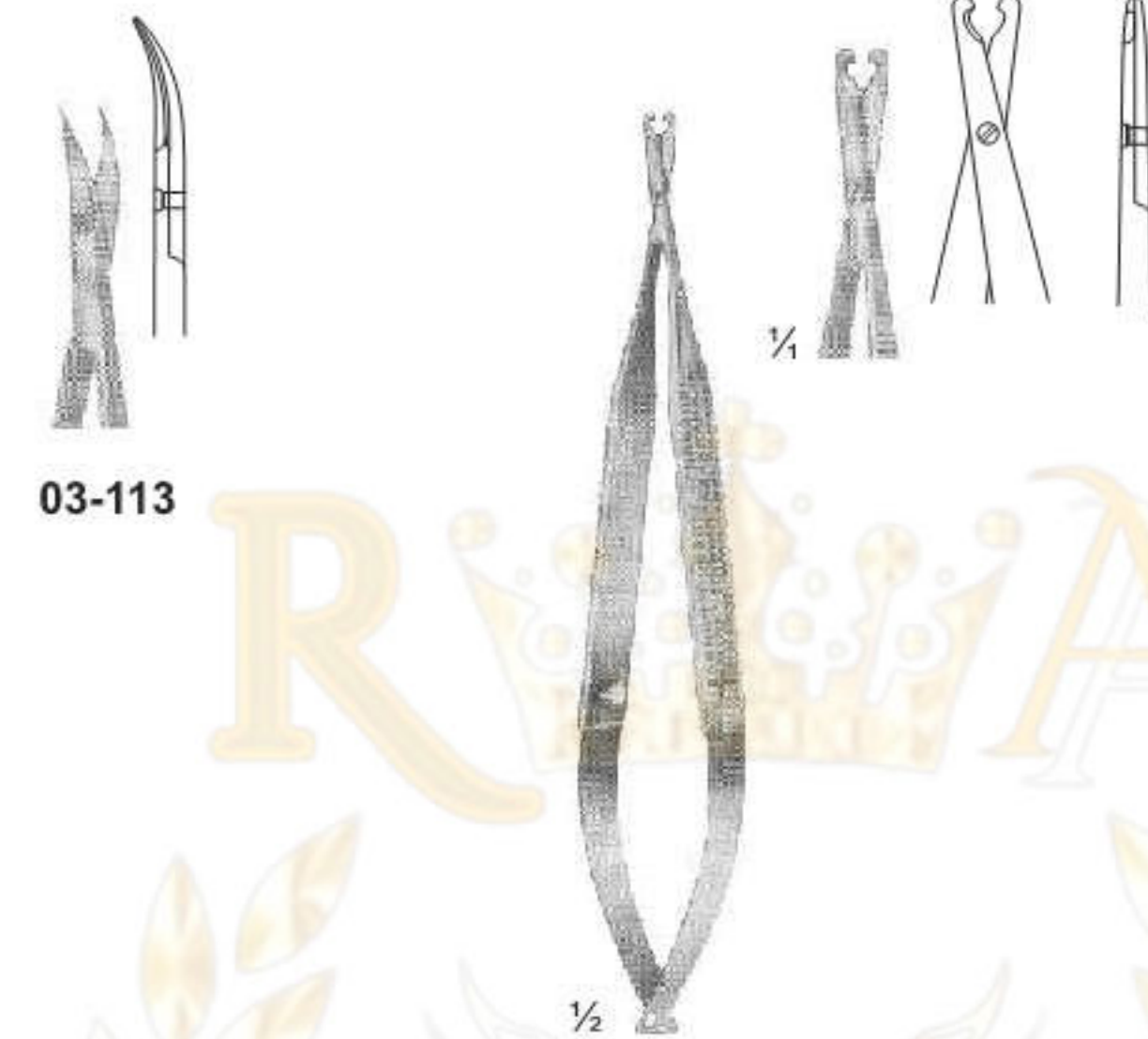

03-114  
03-115

03-114  
BIEMER  
Vein Scissor  
Size: 130 mm  
  
03-115  
Size: 160 mm

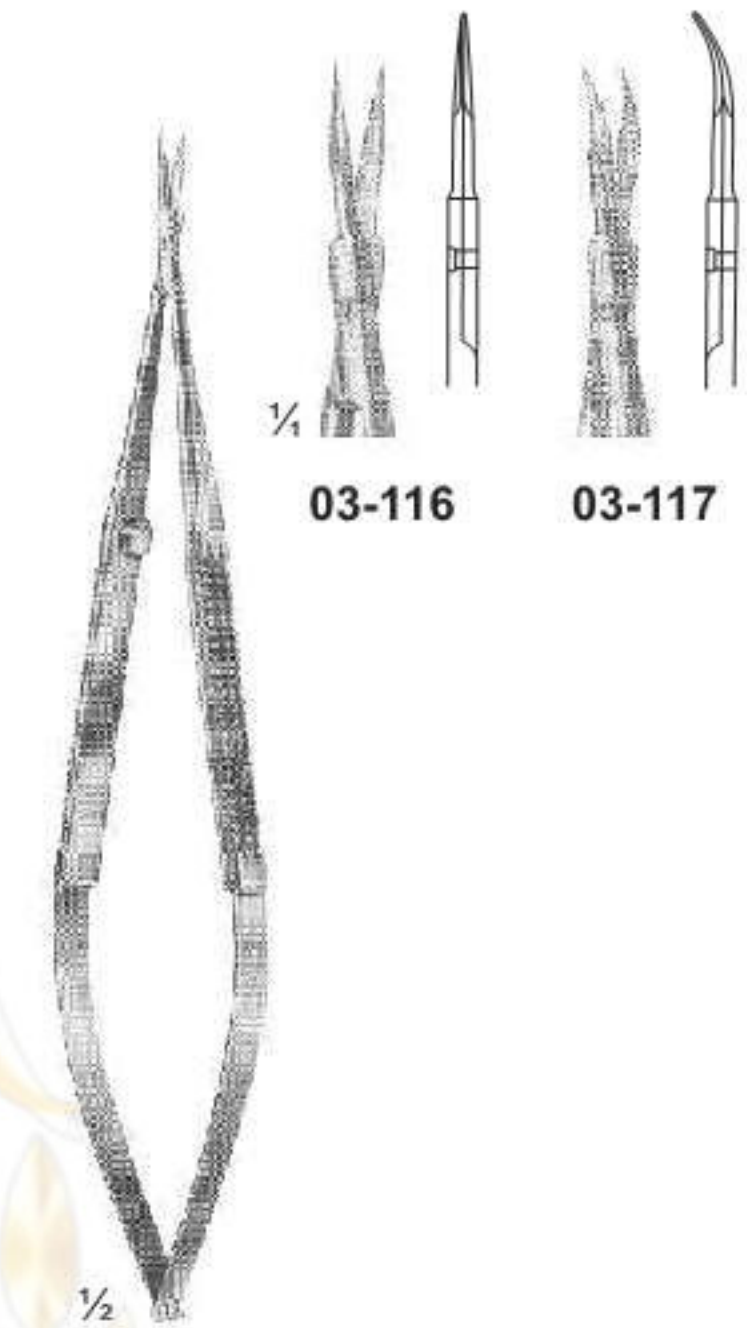

03-116  
03-117

03-116 - 117  
VANNAS  
Size: 160 mm

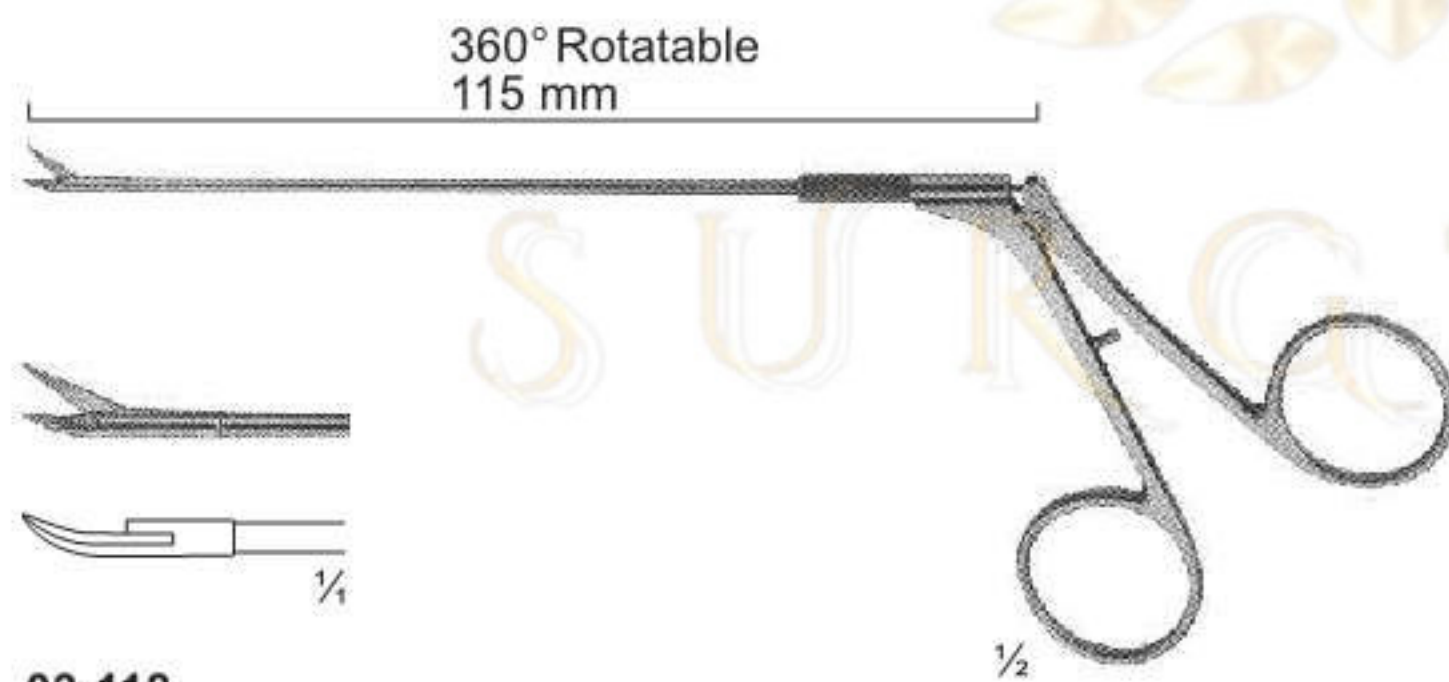

03-118  
CASPAR  
Micro Scissor Curved  
Size: 115 mm

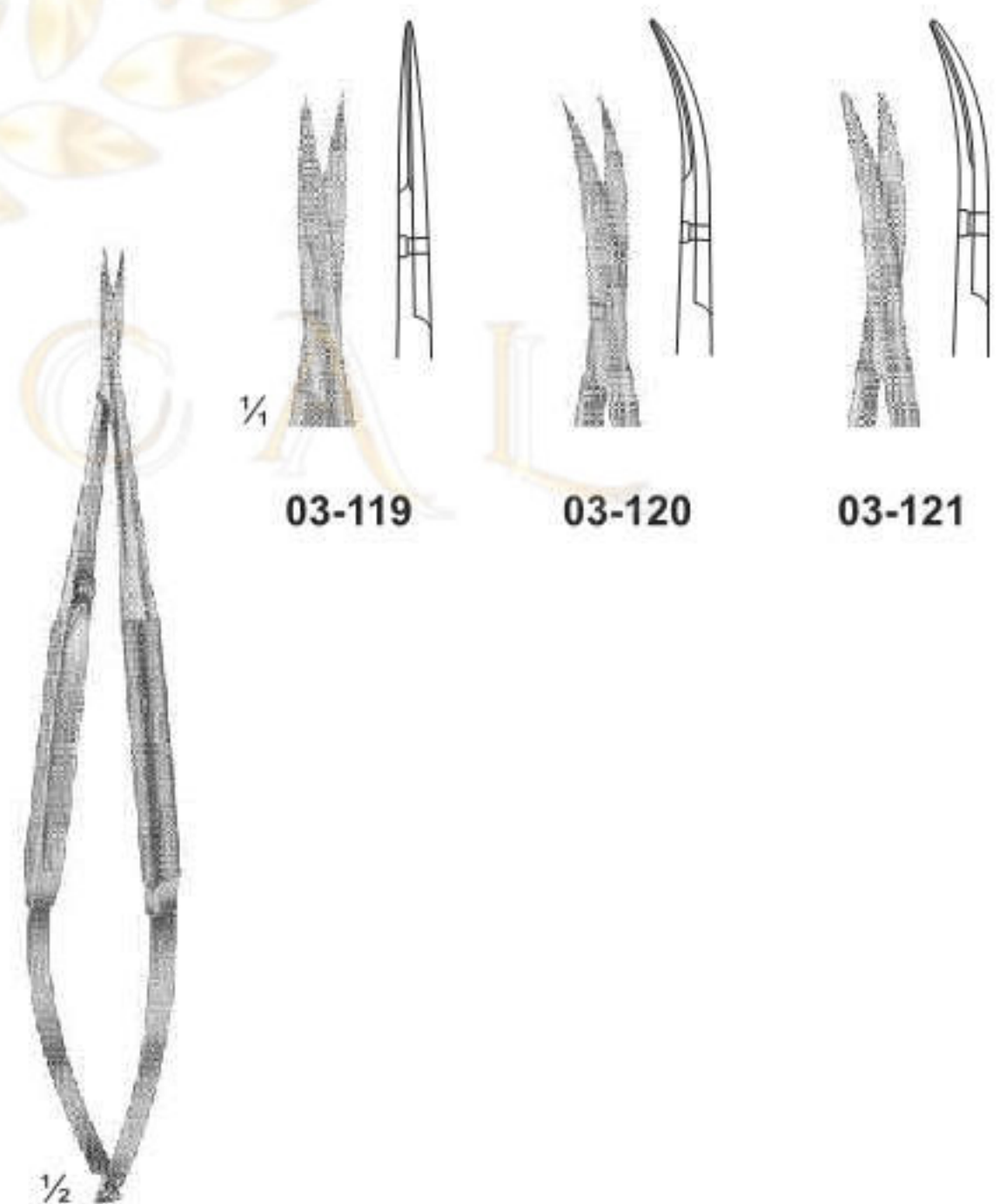

03-119  
03-120  
03-121

03-119 - 121  
Micro Dissecting Scissor  
Size: 145 mm

# Micro Scissors, "Spring Type" Bayonet Shape

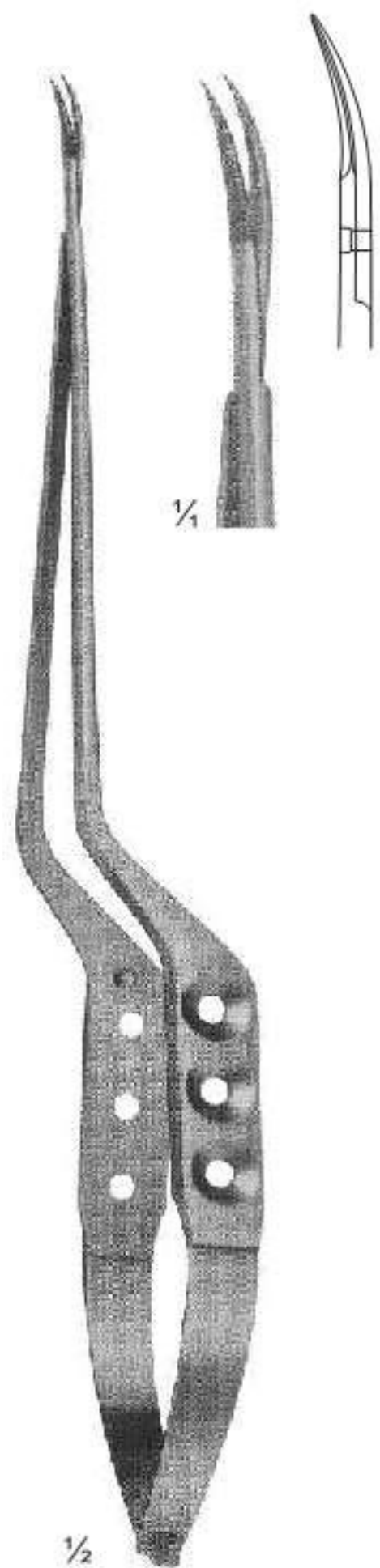

**03-122**  
YASARGIL  
Size: 245 mm

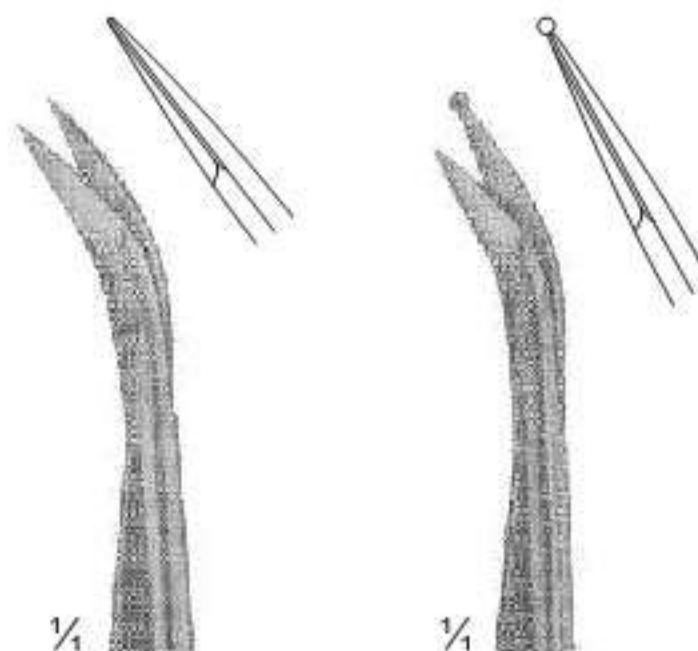

**03-123**

**03-124**



**03-123 - 124**  
Laterally Angled  
Size: 200 mm



**03-125**  
Laterally Angled  
Size: 190 mm

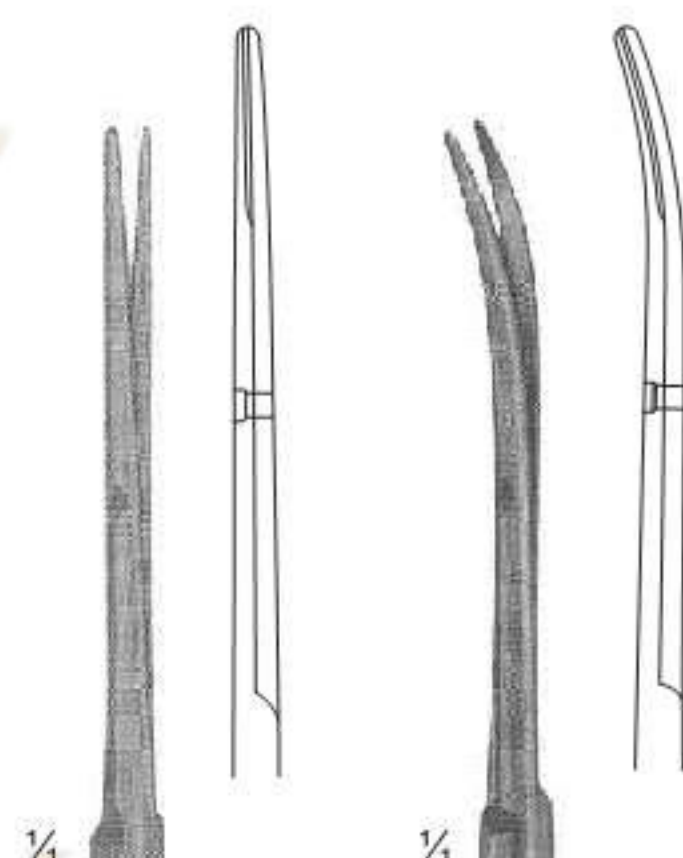

**03-126**

**03-127**



**03-126 - 127**  
YASARGIL  
Size: 225 mm

# Delicate Scissors

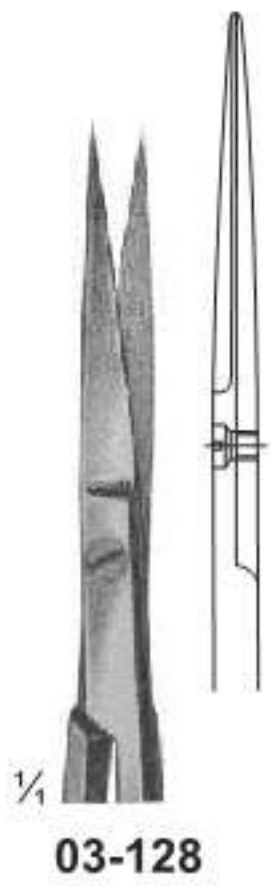
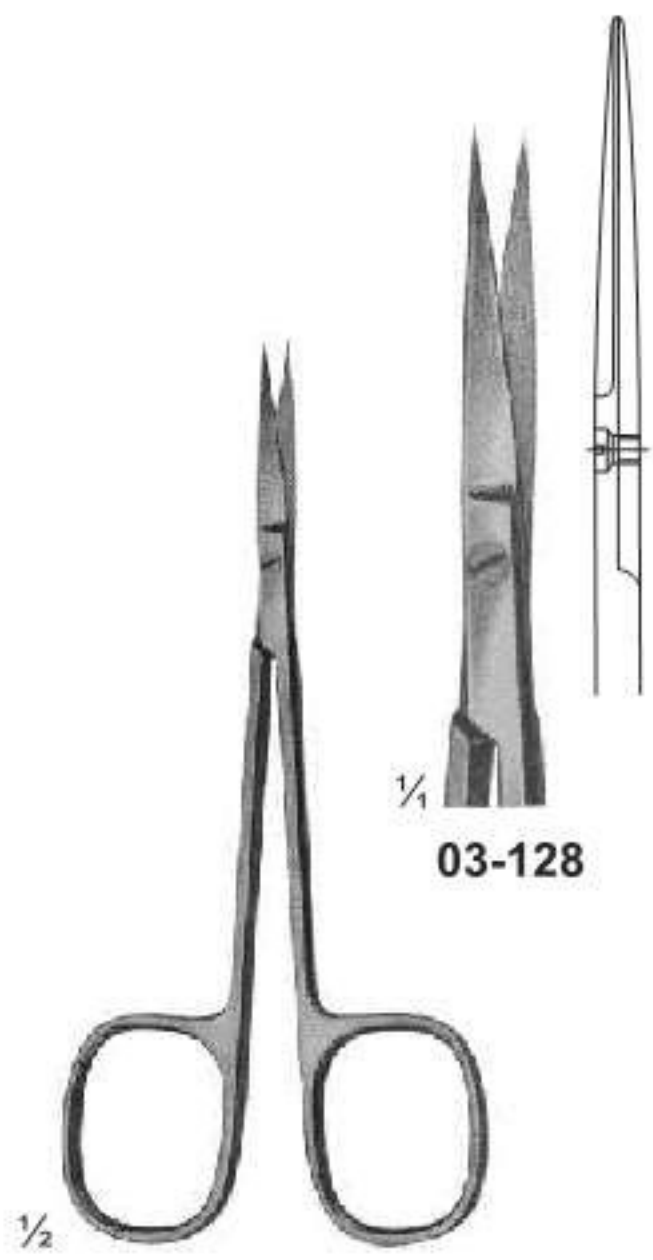

03-128

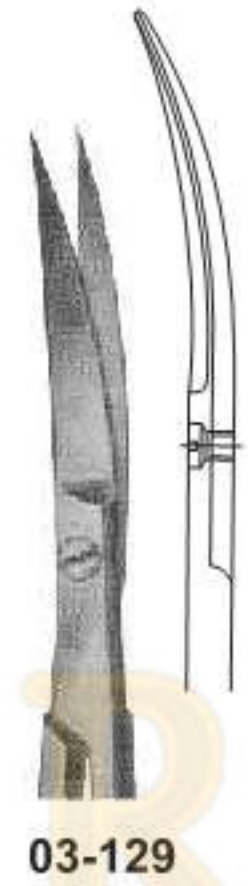

03-129

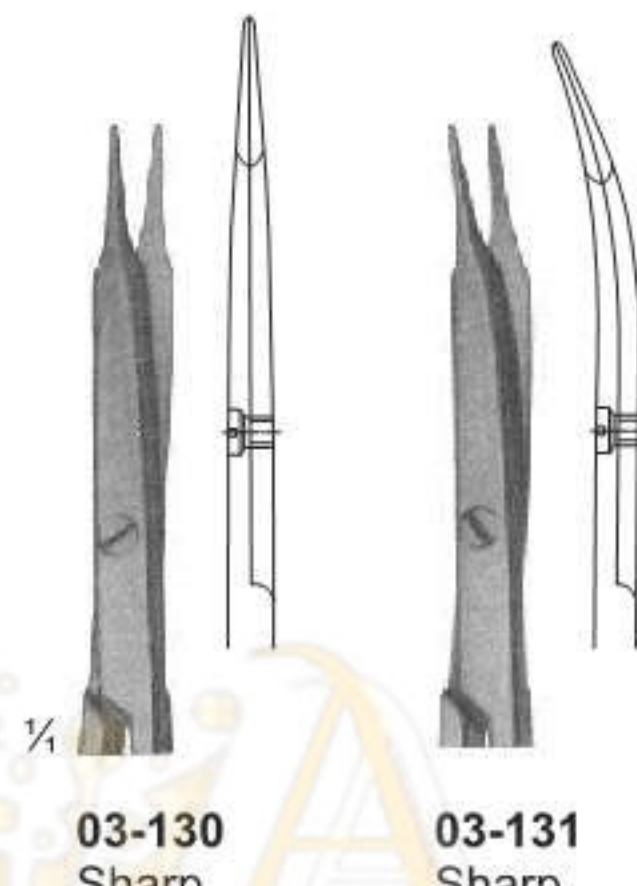
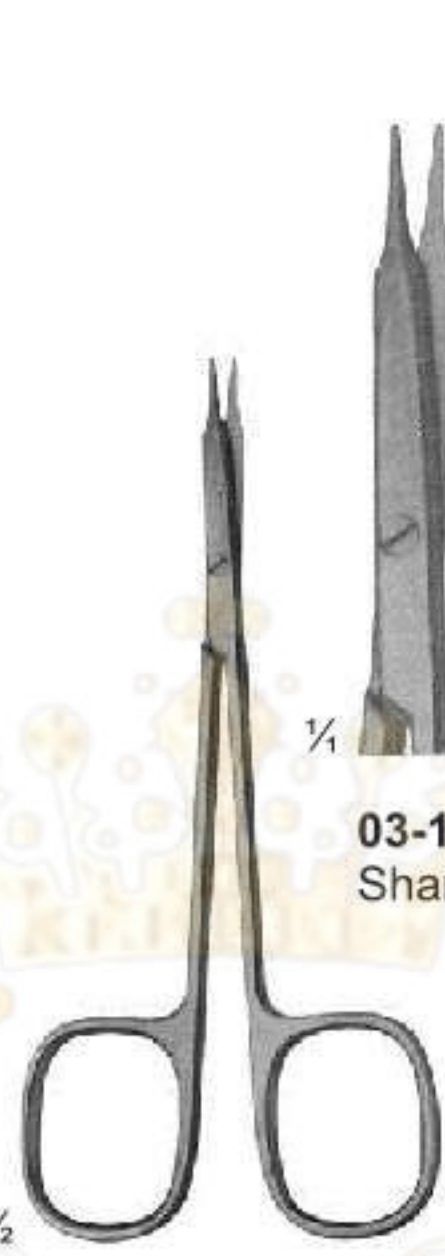

03-130  
Sharp

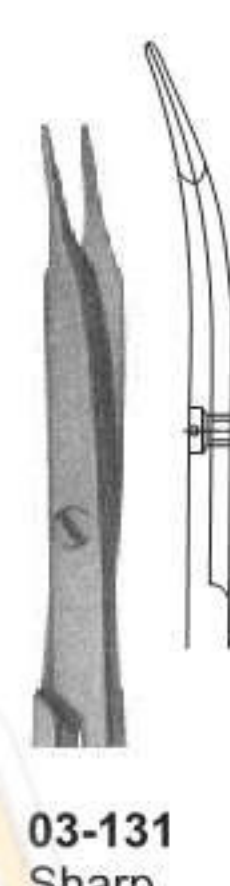

03-131  
Sharp

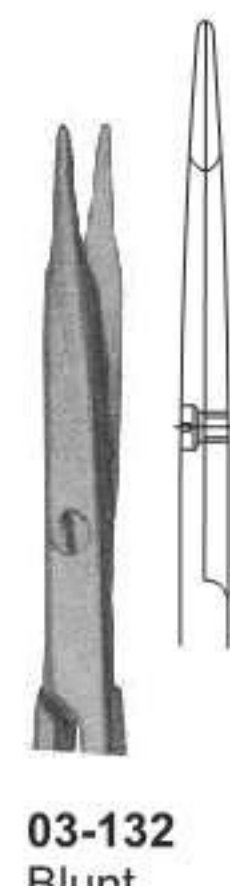

03-132  
Blunt

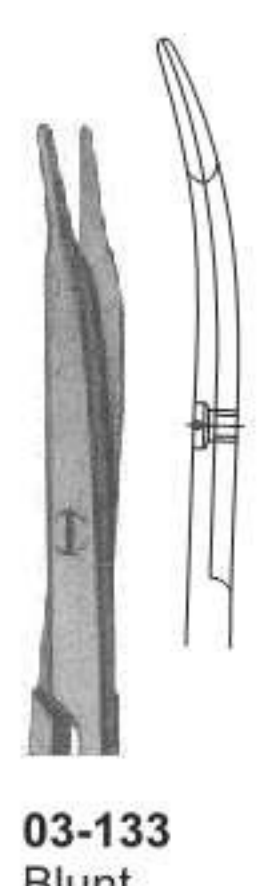

03-133  
Blunt

03-128 - 129  
Size: 120 mm

03-130 - 133  
STEVENS  
Dissecting Scissors  
Size: 115 mm

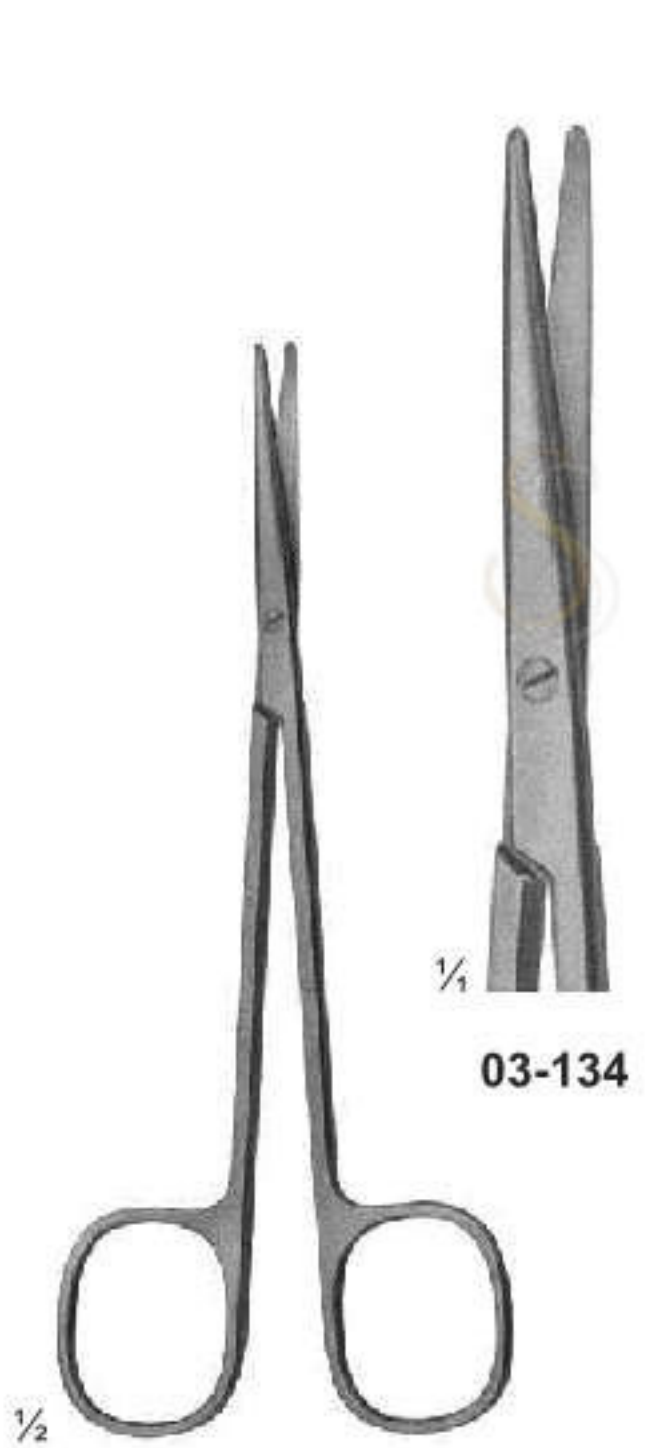

03-134



03-135

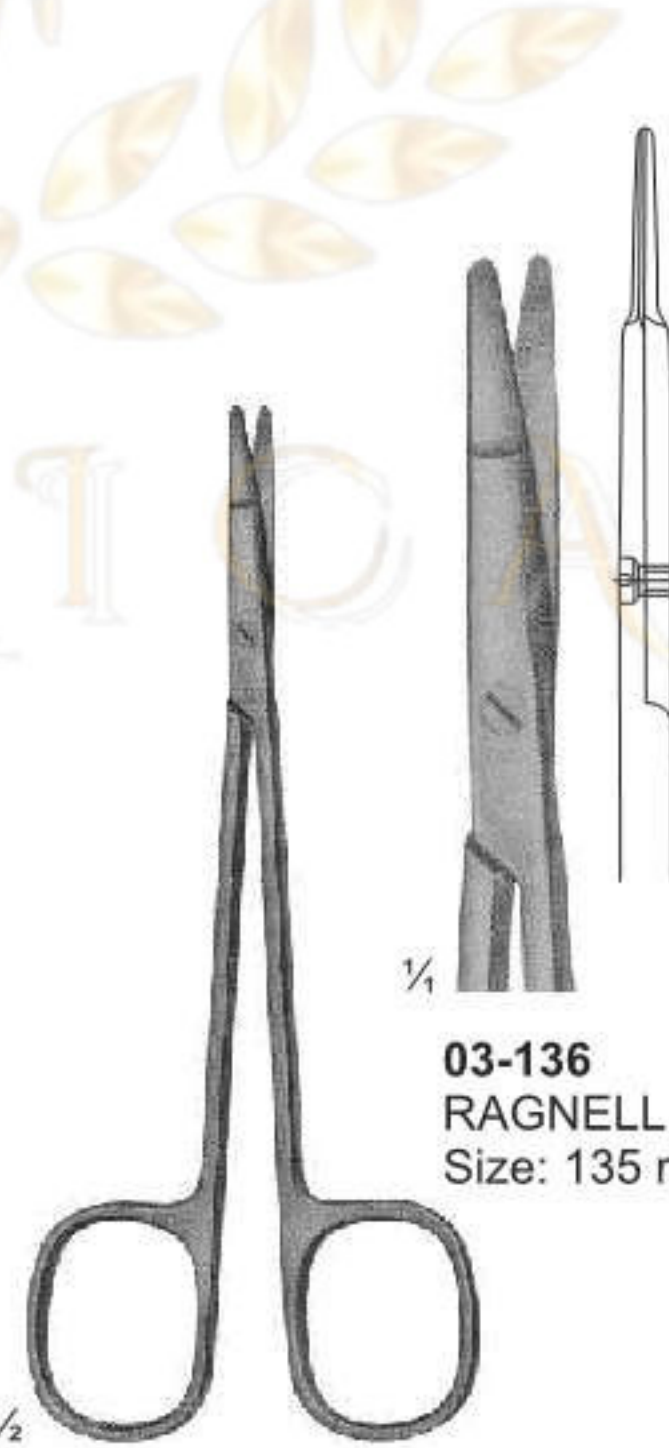

03-136  
RAGNELL  
Size: 135 mm



03-137  
RAGNELL  
Size: 135 mm

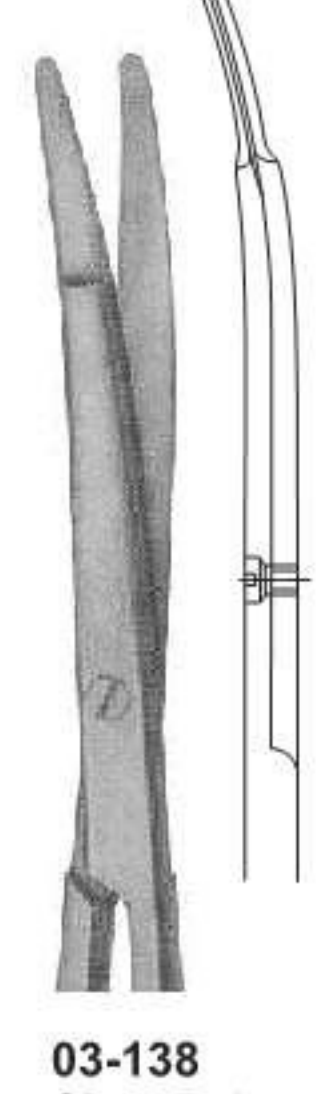

03-138  
Size: 150 mm

03-134 - 135  
METZENBAUM  
Dissecting Scissors  
Size: 145 mm

03-136 - 138  
Special flat points for  
dissecting and  
undermining the skin  
Size: 145 mm

# Delicate Scissors



# Delicate Scissors



**03-149 - 151**  
Size: 120 mm

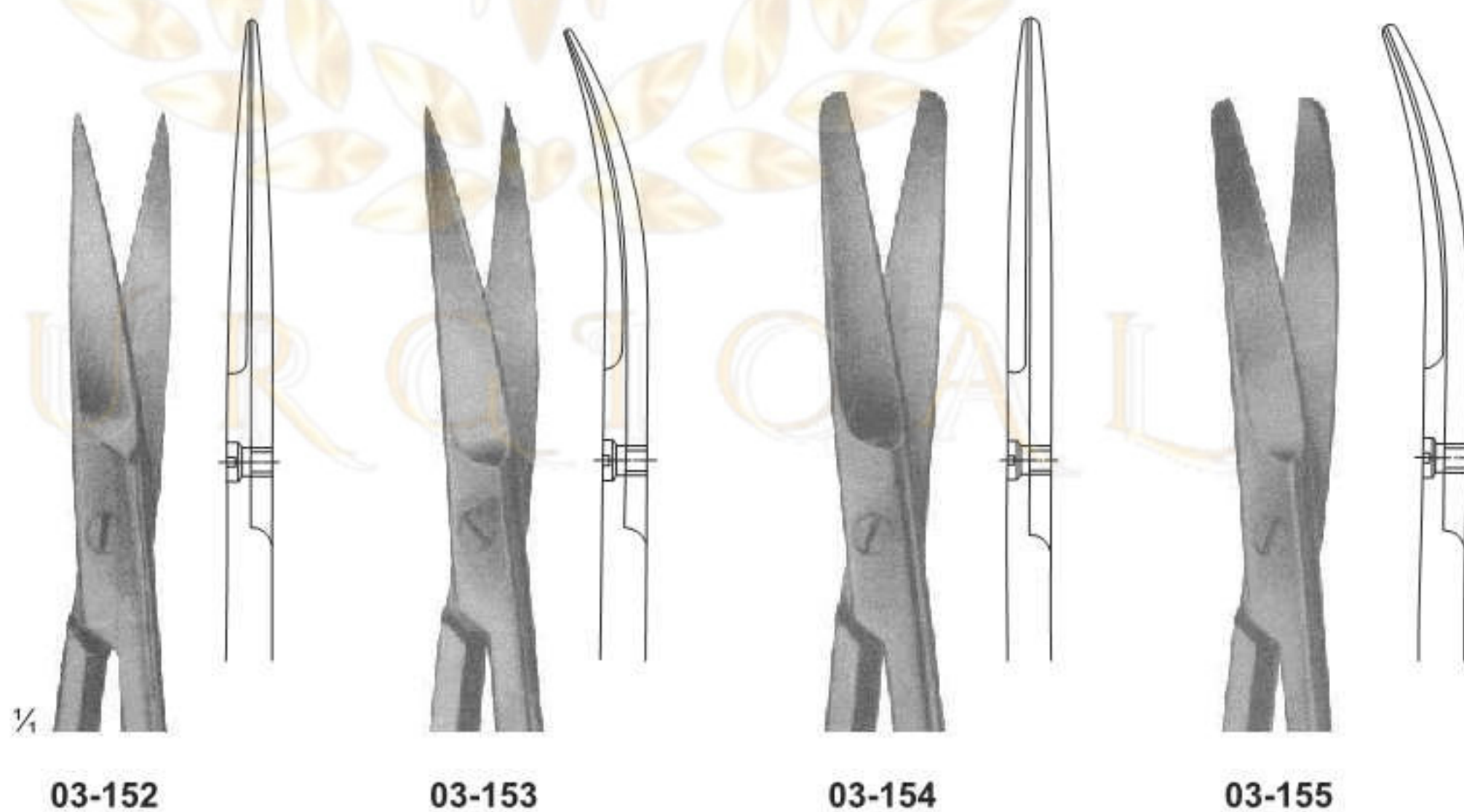

**03-152 - 155**  
Size: 130 mm

# Delicate Scissors

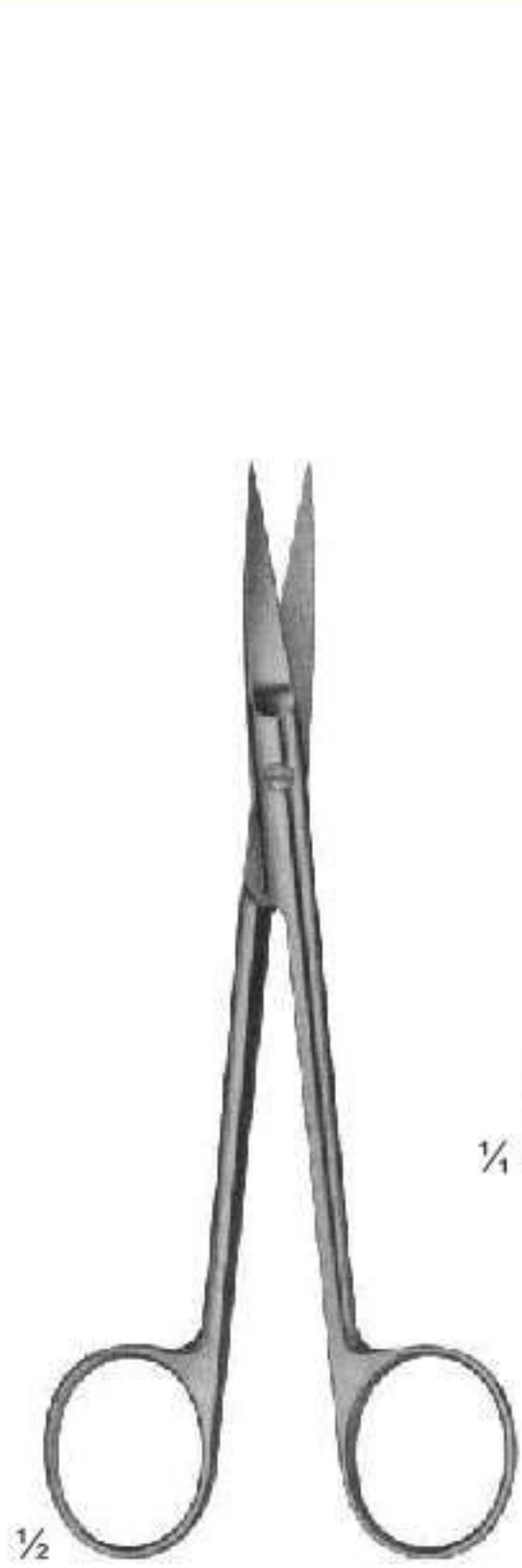

**03-156**

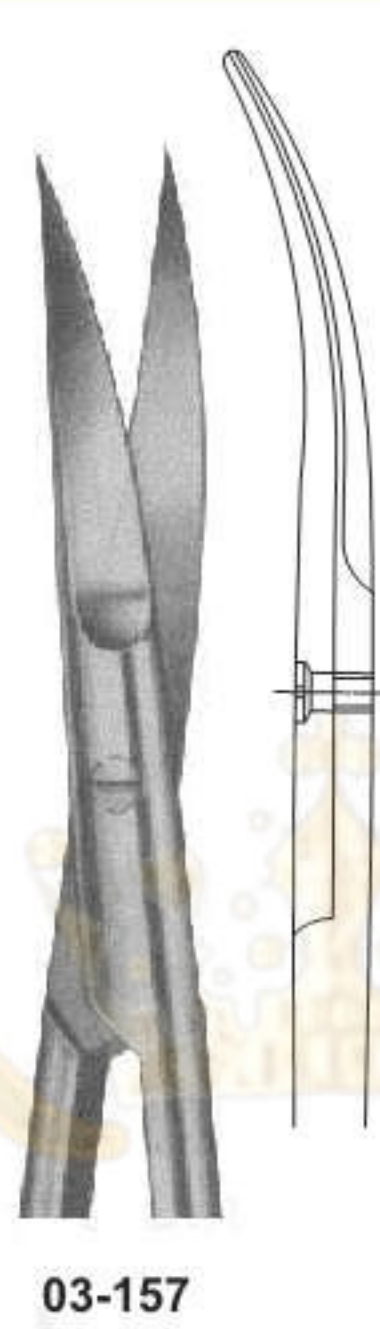

**03-157**

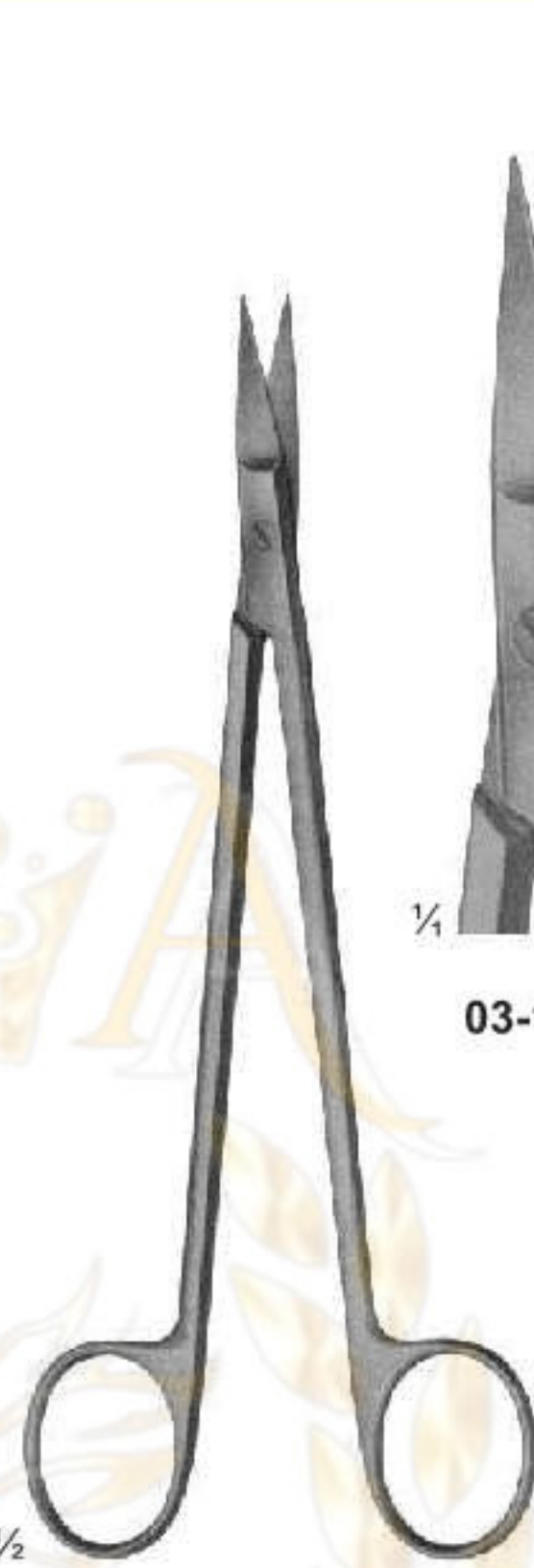
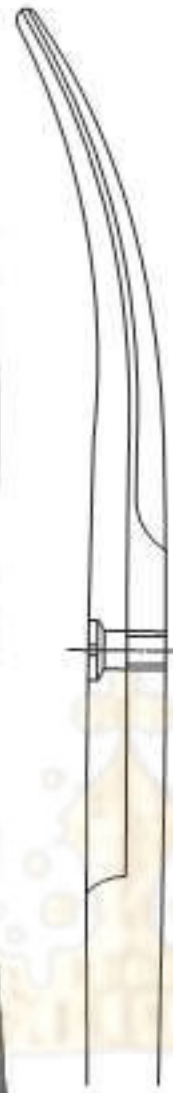

**03-158**

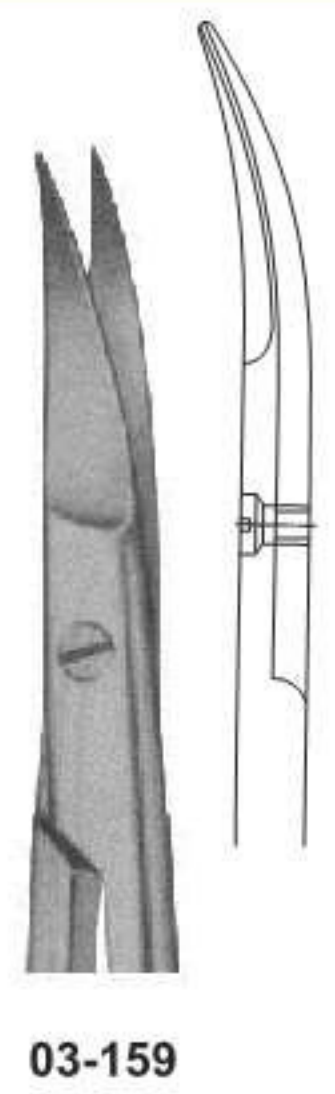

**03-159**

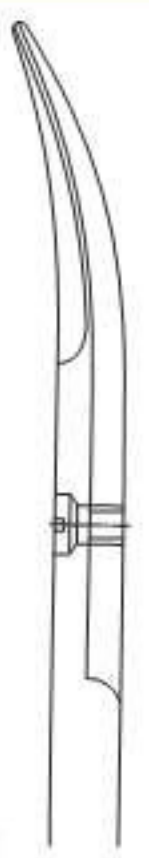
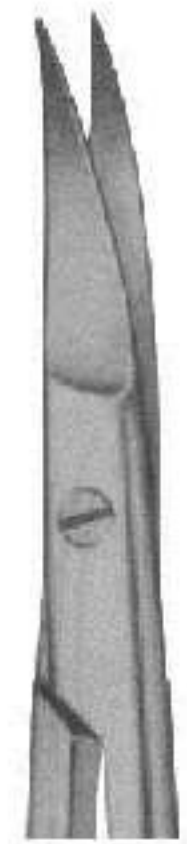

**03-156 - 157**  
JOSEPH  
Size: 150 mm

**03-158 - 159**  
KELLY  
Size: 175 mm

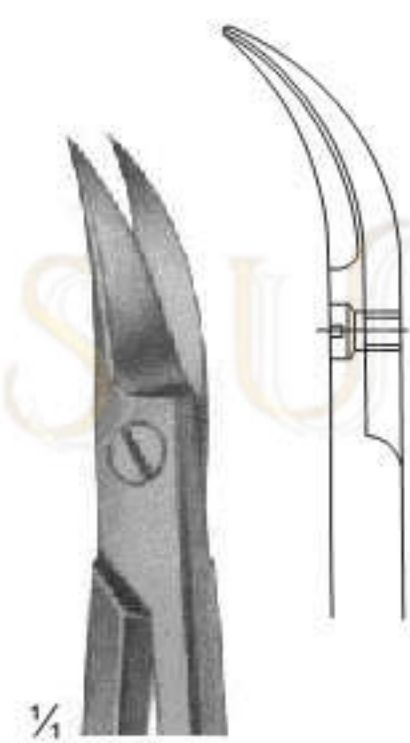
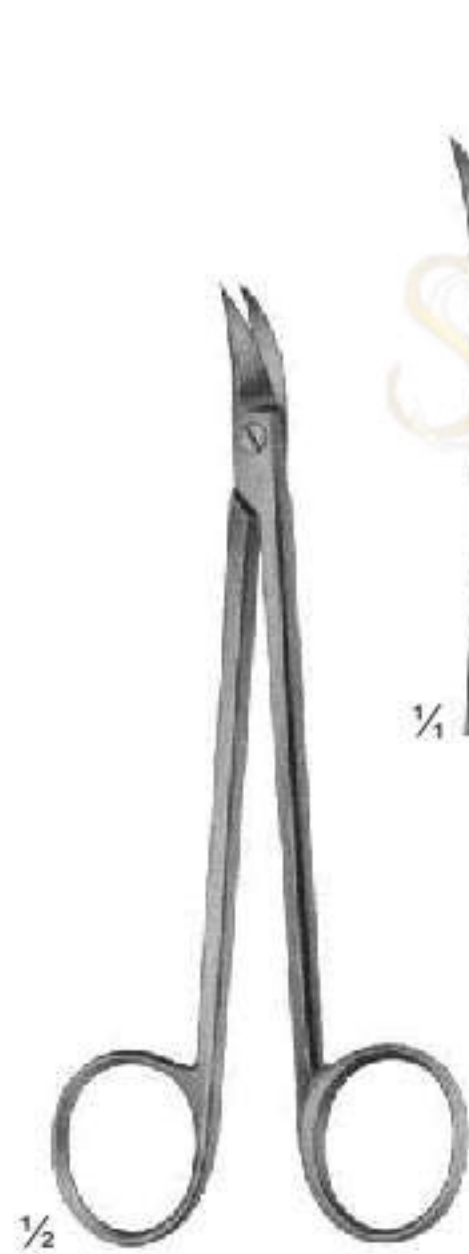

**03-160**  
QUINBY  
Size: 130 mm

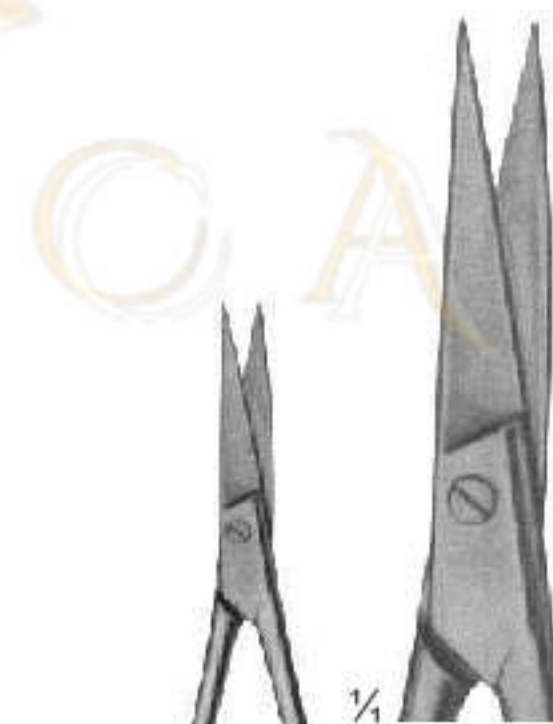
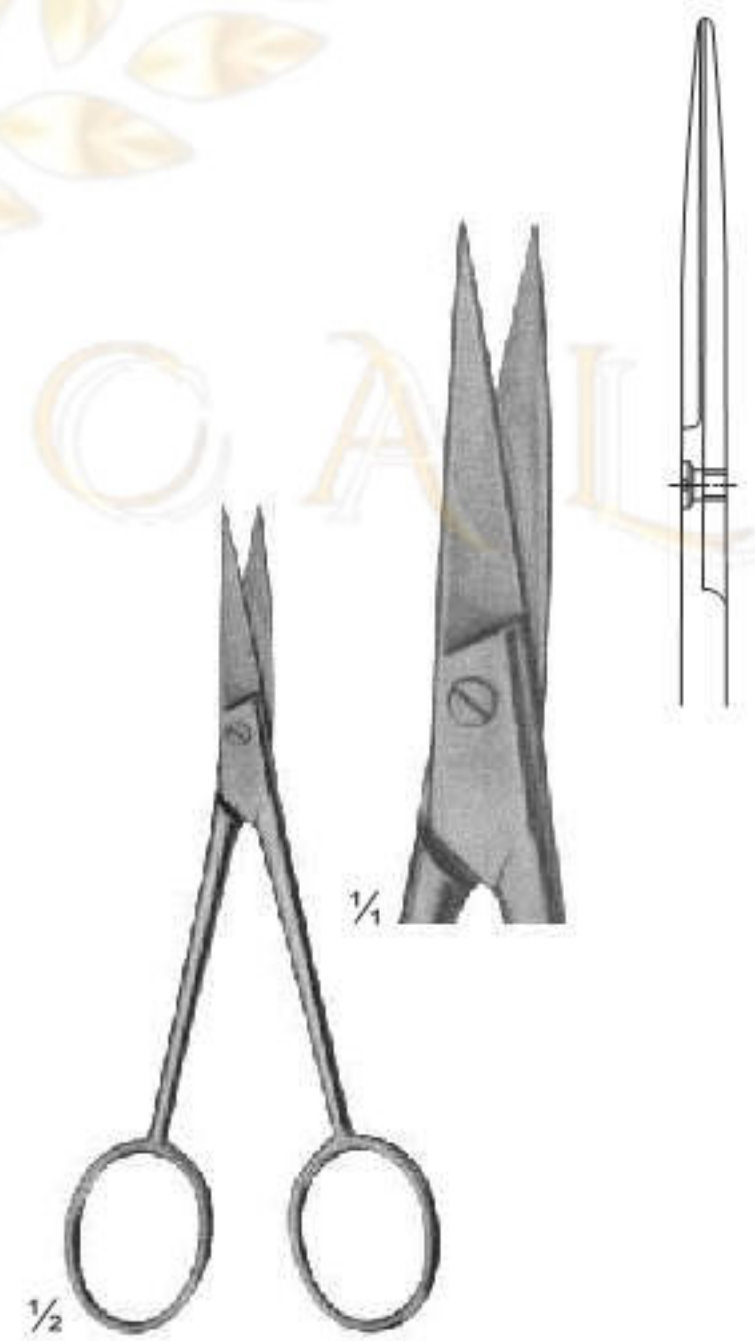

**03-161**  
Size: 110 mm

# Surgical Scissors



**03-162 - 170 (Standard Types)** Size: 105 mm Size: 200 mm  
 03-162 ( 105 mm )  
 03-163 ( 115 mm )  
 03-164 ( 130 mm )  
 03-165 ( 145 mm )  
 03-166 ( 150 mm )  
 03-167 ( 165 mm )  
 03-168 ( 175 mm )  
 03-169 ( 185 mm )  
 03-170 ( 200 mm )

**03-171 - 177 (Standard Types)**  
 03-171 ( 115 mm )  
 03-172 ( 130 mm )  
 03-173 ( 145 mm )  
 03-174 ( 150 mm )  
 03-175 ( 165 mm )  
 03-176 ( 175 mm )  
 03-177 ( 185 mm )

**03-171** Size: 115 mm  
**03-177** Size: 185 mm



**03-178 - 181**  
 Slender Types

**03-182 - 183**  
 For Wound Edges  
 1 Blade Serrated

# Surgical Scissors



**03-184 - 188 (Standard Types)**  
**03-184** ( 130 mm )  
**03-185** ( 145 mm )  
**03-186** ( 150 mm )  
**03-187** ( 165 mm )  
**03-188** ( 175 mm )

**03-184** Size: 130 mm    **03-188** Size: 175 mm

**03-189 - 194 - COOPER Standard Types**  
**03-189** ( 115 mm )  
**03-190** ( 130 mm )  
**03-191** ( 145 mm )  
**03-192** ( 150 mm )  
**03-193** ( 165 mm )  
**03-194** ( 175 mm )

**03-189** Size: 115 mm    **03-194** Size: 175 mm



**03-195 - 199 Standard Types**  
**03-195** ( 115 mm )  
**03-196** ( 130 mm )  
**03-197** ( 145 mm )  
**03-198** ( 150 mm )  
**03-199** ( 165 mm )

**03-195** Size: 115 mm    **03-199** Size: 165 mm

**03-200 - 203 Standard Types**  
**03-200** ( 115 mm )  
**03-201** ( 130 mm )  
**03-202** ( 145 mm )  
**03-203** ( 150 mm )

**03-200** Size: 115 mm    **03-203** Size: 150 mm



# Surgical Scissors



SURGICAL

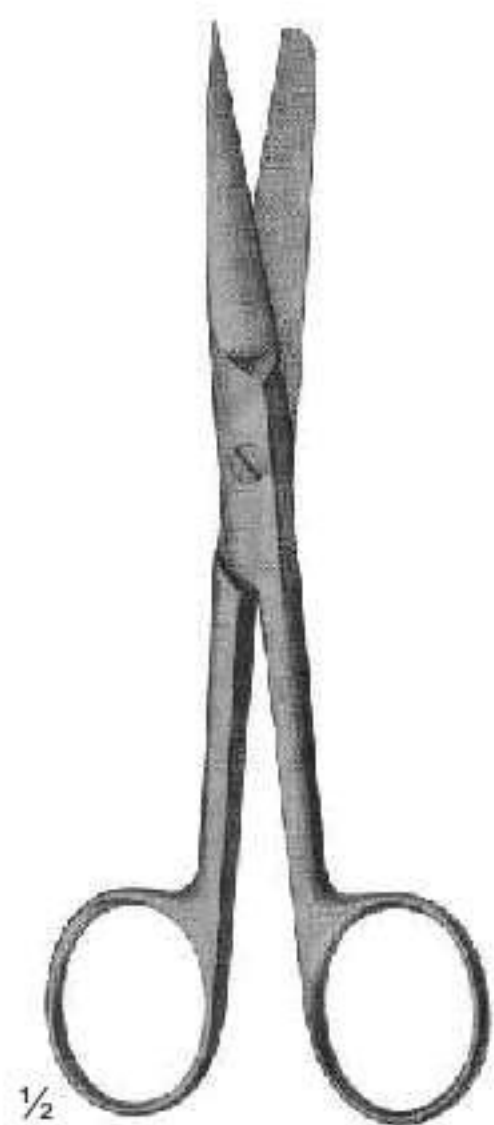

**03-204 - 206**  
DEAVER  
With flat lock



1/4

**03-204**  
Size: 145 mm



**03-205**  
Size: 145 mm



**03-206**  
Size: 145 mm



**03-207 - 209**  
Incision Scissors



1/4

**03-207**  
Size: 130 mm



**03-208**  
Size: 145 mm



**03-209**  
Size: 165 mm

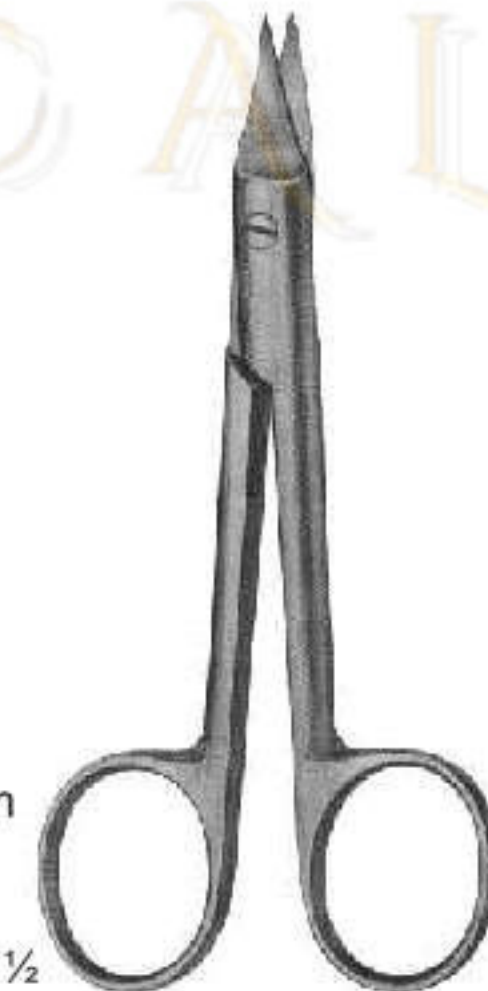

**03-210**  
SYSTRUNK  
Nail Splitting Scissors



1/4

**03-210**  
Size: 130 mm

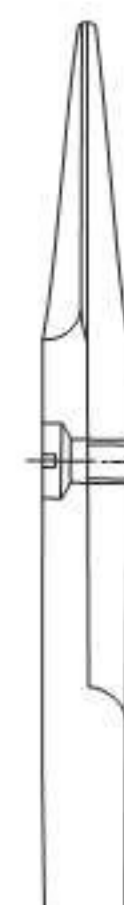

# Dissecting Scissors

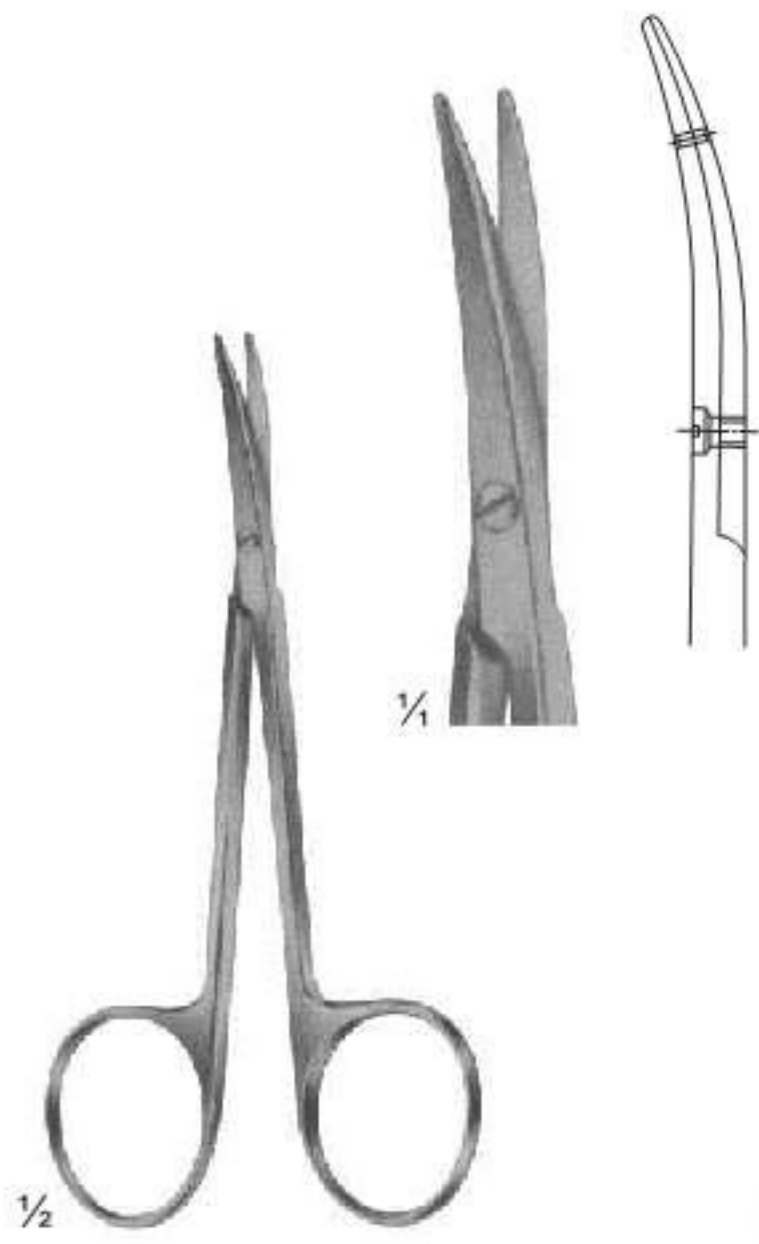

**03-211**  
LITTLER  
Dissecting Scissors  
Tips with eye for suture  
Size: 115 mm



**03-212**  
COTTLE  
Bulldog Scissors  
Size: 115 mm

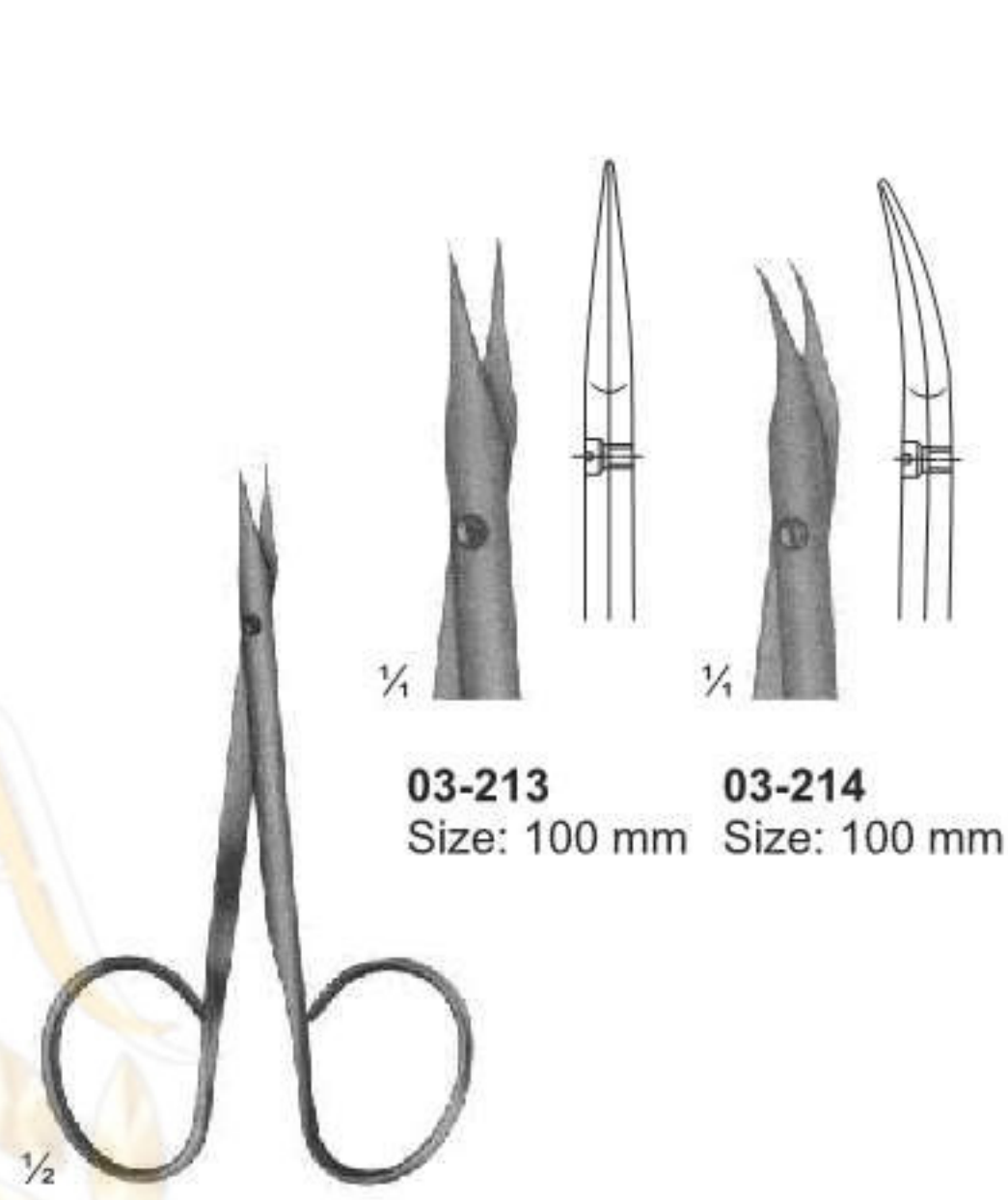

**03-213**      **03-214**  
Size: 100 mm    Size: 100 mm

**03-213 - 214**  
STEVENS  
Vessel and tendon Scissors  
Size: 100 mm

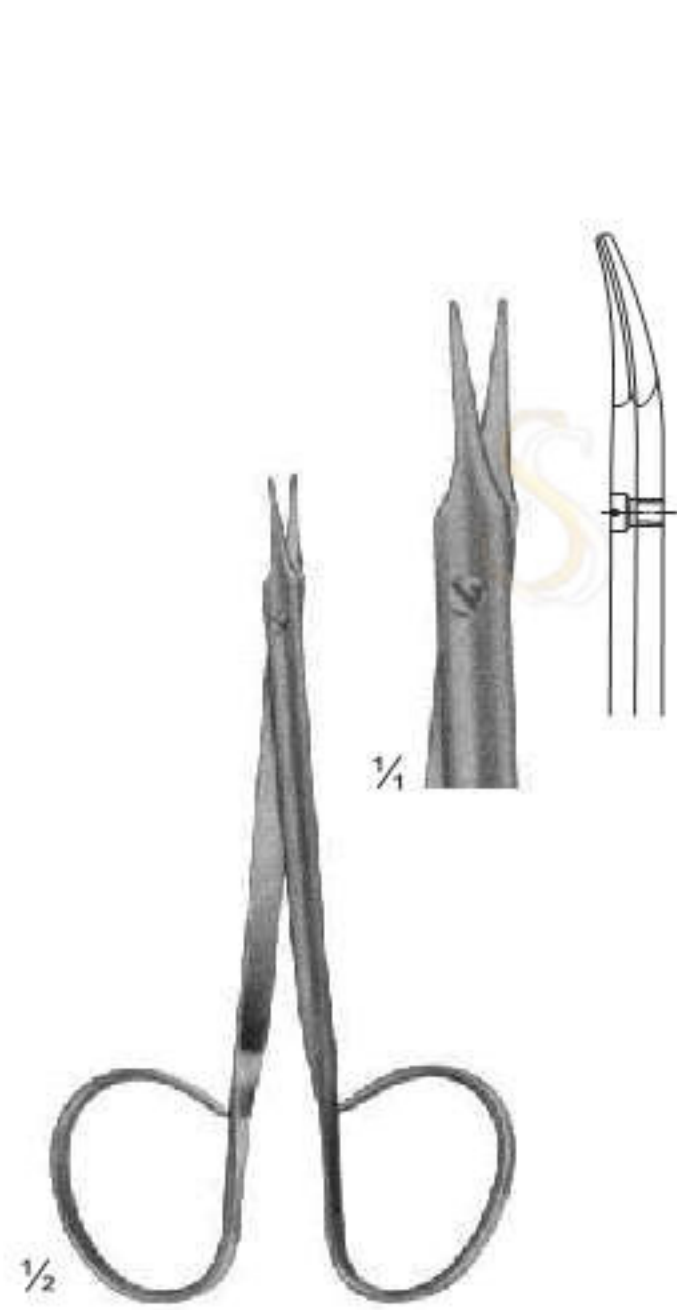

**03-215**  
STEVENS  
Fine Dissecting Scissors  
Size: 110 mm

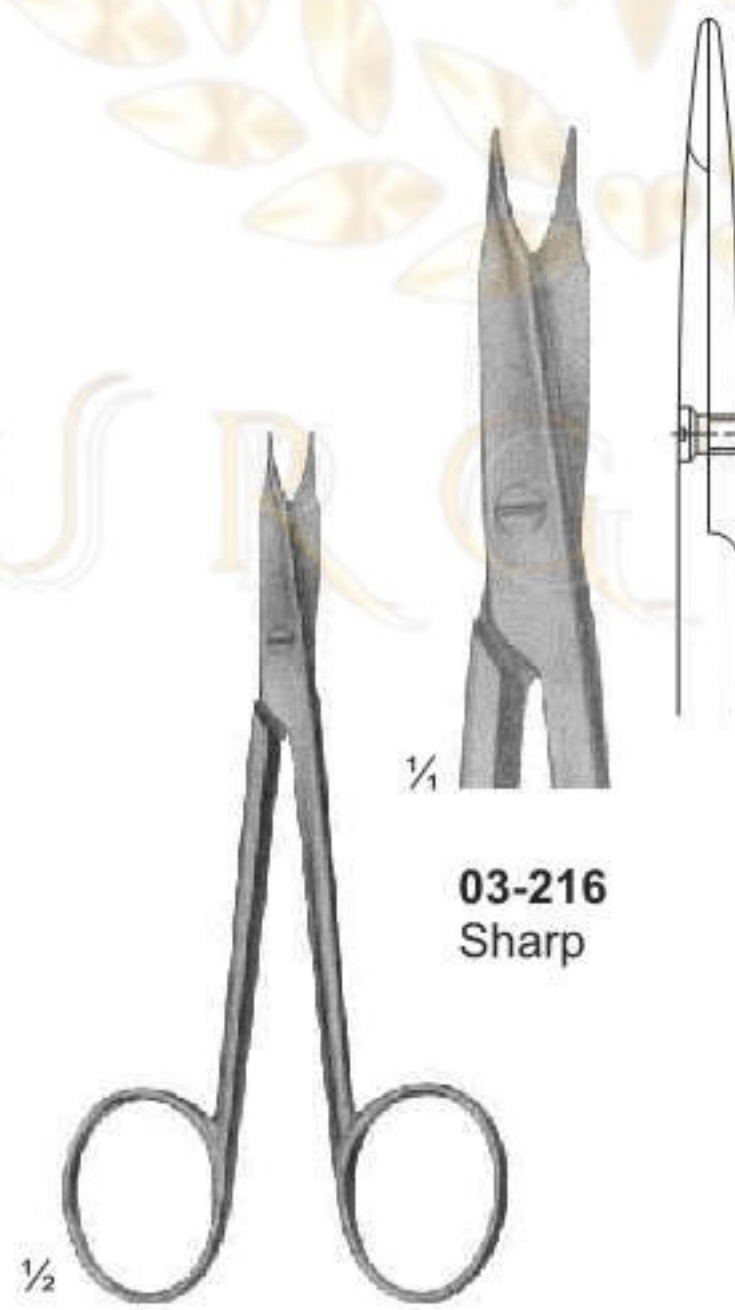

**03-216**  
Sharp

**03-216 - 219**  
STEVENS  
Vessel and tendon Scissors  
Size: 110 mm

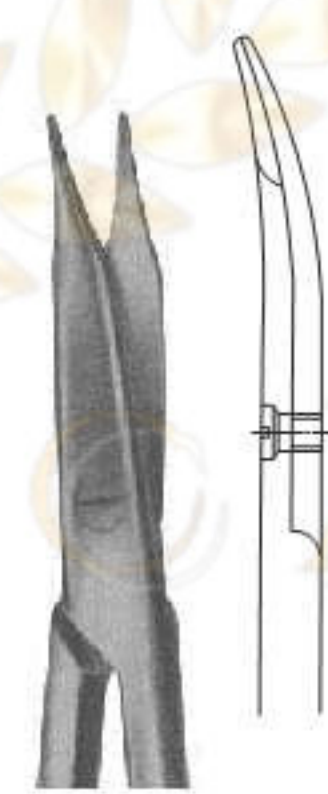

**03-217**  
Sharp

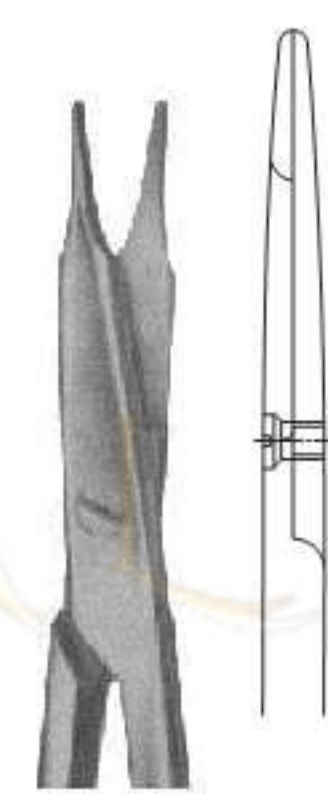

**03-218**  
Blunt

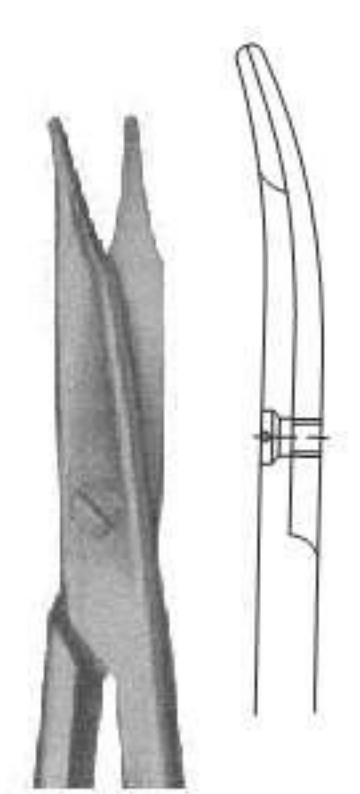

**03-219**  
Blunt

# Dissecting Scissors



**03-220 - 221**  
**KILNER**  
 Special flat points for dissecting and undermining the skin

**03-222**  
**KILNER**  
 Fine dissecting scissors  
 Size: 115 mm

**03-223**  
**JAMESON**  
 Dissecting scissors  
 Size: 150 mm

**03-224**  
**REYNOLDS**  
 Dissecting scissors  
 Size: 145 - 175 mm



**03-225**  
**DE BAKEY**  
 Ateriotomy scissors  
 Size: 175 mm

**03-226 - 227**  
**TOENNISADSON**  
 Dissecting scissors  
 Size: 175 mm

**03-228 - 230**  
**TOENNIS**  
 Dissecting scissors  
 Size: 150 mm

# Dissecting & Surgical Scissors



**03-231**  
Size: 115 mm

**03-232**  
Size: 135 mm

**03-233**

**03-234**

**03-231 - 232**  
FOMON  
Lower lateral scissors

**03-233 - 234**  
LANDOLT  
Enucleation scissors  
Size: 120 mm



**03-235**  
Size: 140 mm

**03-238 - 240**  
MAYO  
03-238 (140 mm)  
03-239 (155 mm)  
03-240 (170 mm)

**03-241**  
Size: 140 mm

**03-243 - 244**  
MAYO-STILLE  
03-243 (140 mm)  
03-244 (170 mm)

**03-235 - 237**  
MAYO  
03-235 (140 mm)  
03-236 (155 mm)  
03-237 (170 mm)

**03-241 - 242**  
MAYO-STILLE  
03-241 (140 mm)  
03-242 (170 mm)

# Dissecting Scissors



**03-245**  
Size: 140 mm

**MAYO-STILLE**  
**03-247 - 248**  
Size: 140 mm  
**03-248**  
Size: 170 mm

**03-249**  
Size: 190 mm

**MAYO**  
**03-251**  
Size: 190 mm  
**03-252**  
Size: 215 mm

**03-245 - 246**  
**MAYO-STILLE**  
With chamfered blades  
**03-245** (140 mm)  
**03-246** (170 mm)

**MAYO**  
With chamfered blades  
**03-249** (190 mm)  
**03-250** (215 mm)

**03-253**  
Size: 170 mm

**03-254**  
Size: 170 mm

**03-255**  
Size: 230 mm

**03-256**  
Size: 230 mm

**03-253 - 254**  
**MAYO-NOBLE**  
Broad pattern

**03-255 - 256**  
**MAYO-HARRINGTON**

# Dissecting Scissors

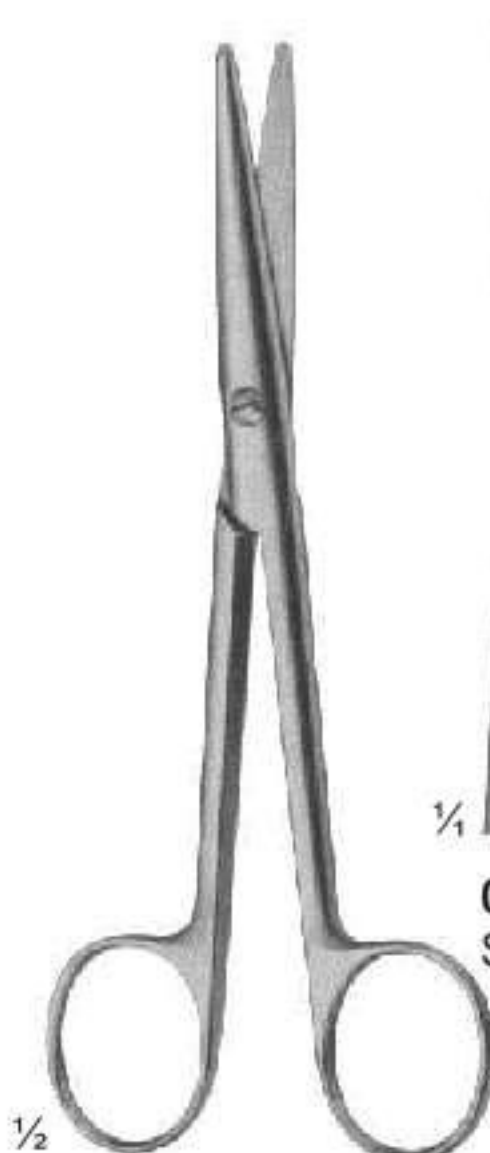

**03-257 - 258**  
STILLE  
Size: 150 mm

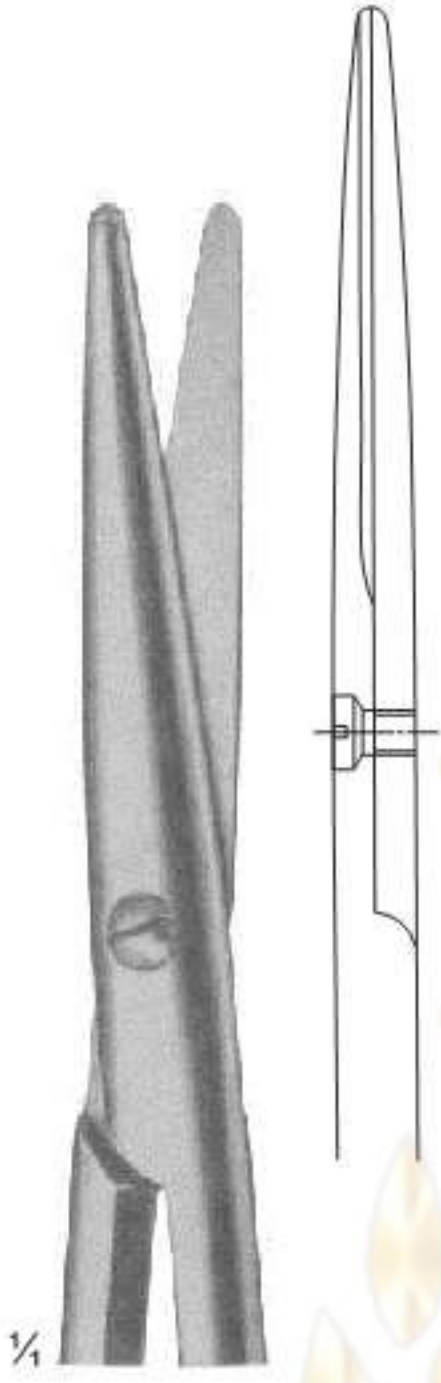

**03-257**  
Size: 150 mm

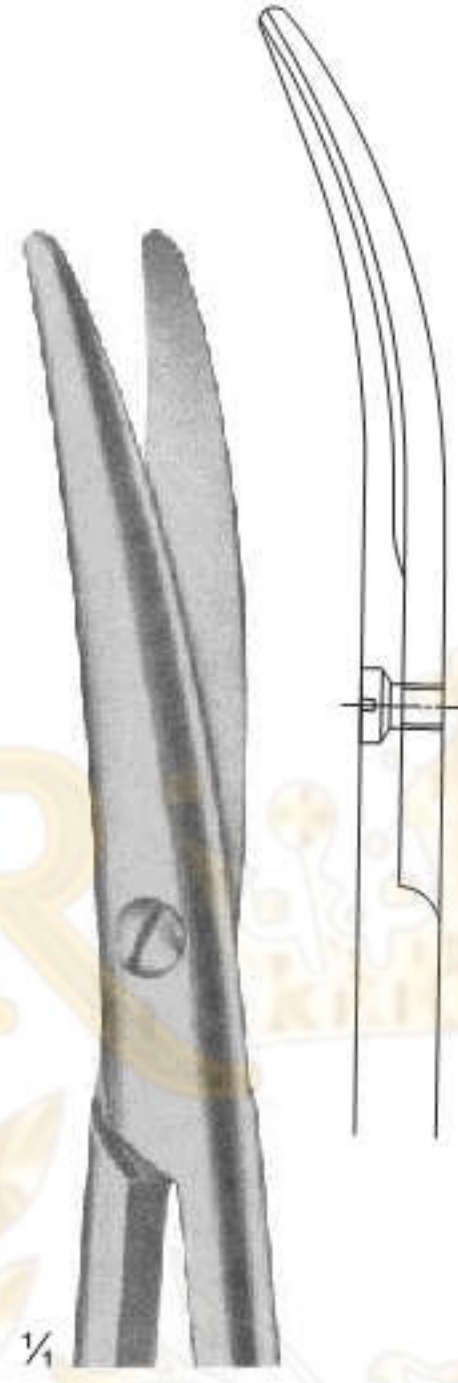

**03-258**  
Size: 150 mm



**03-259 - 260**  
LEXER  
Narrow  
Size: 165 mm

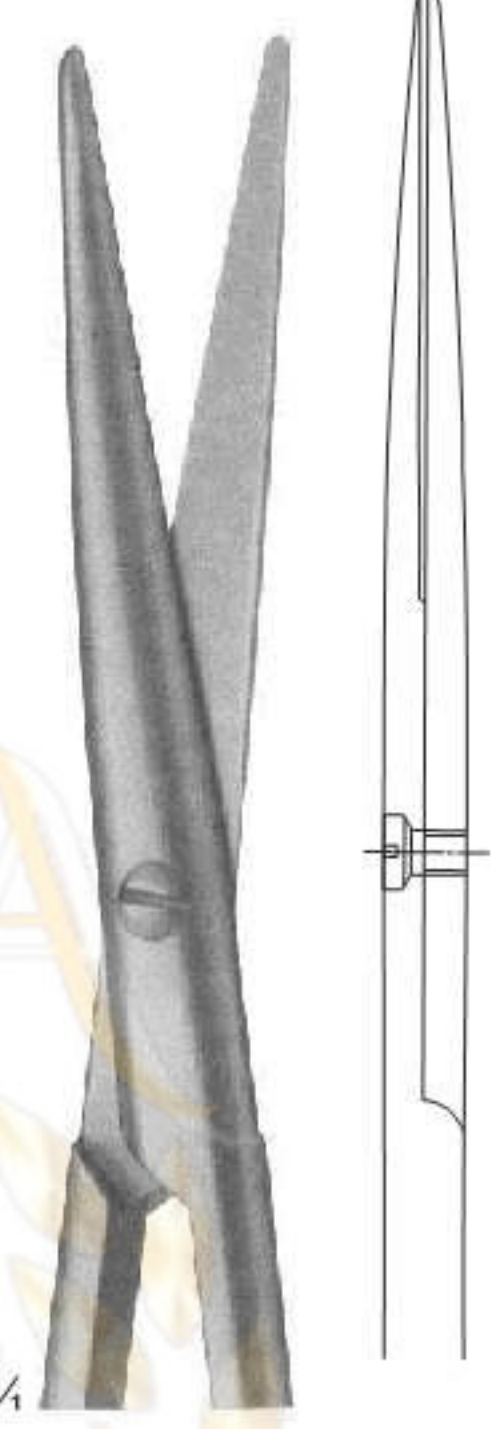

**03-259**  
Size: 165 mm

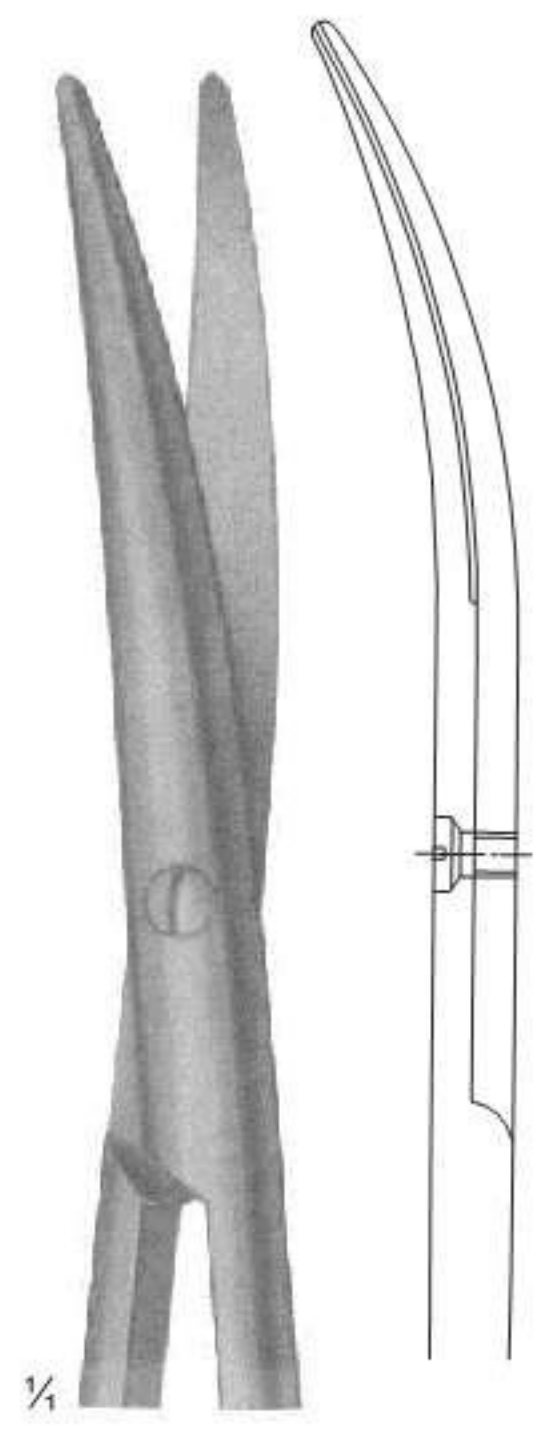

**03-260**  
Size: 165 mm

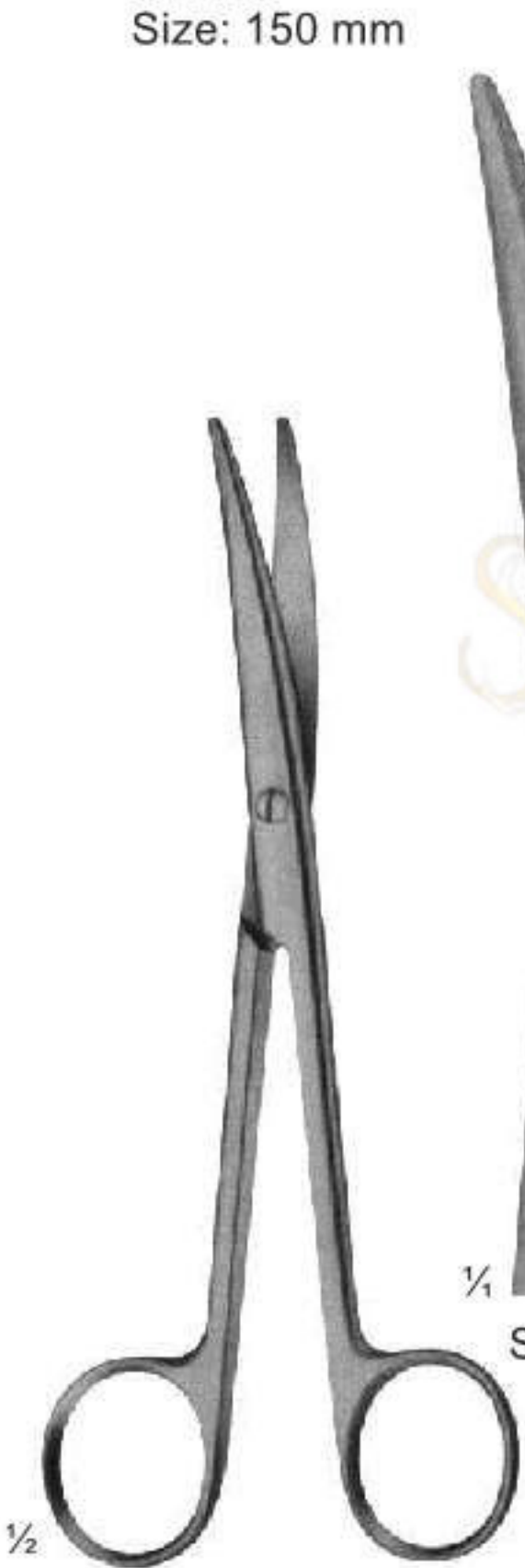

**03-261**  
MAYO-LEXER  
Standard

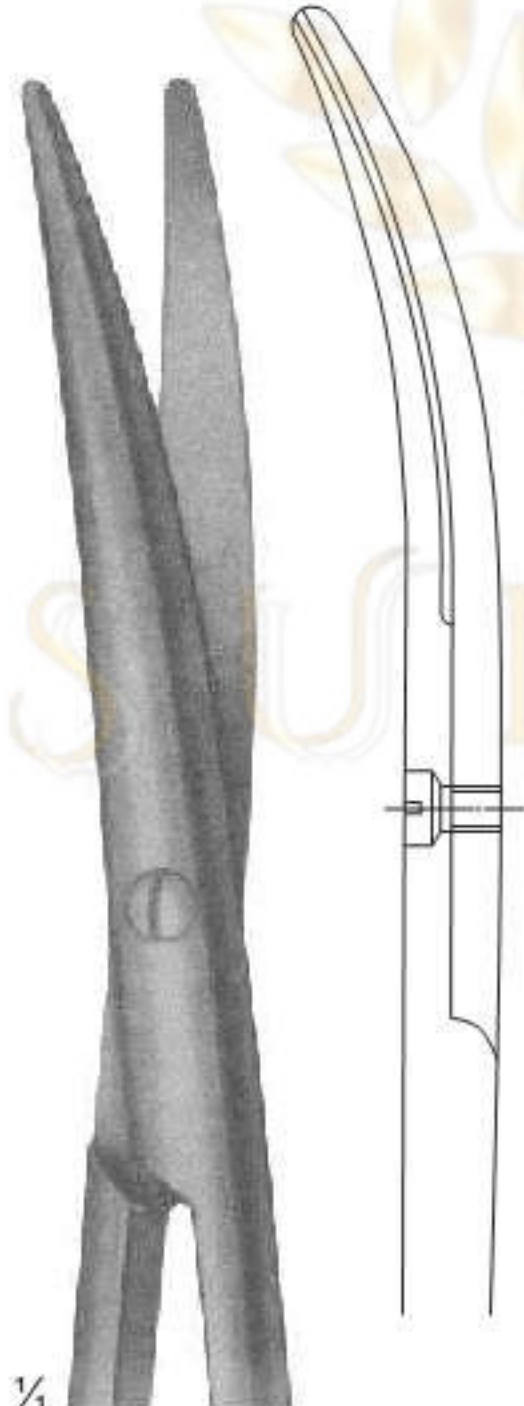

Size: 165 mm



**03-262 - 263**  
MAYO  
**03-262** (165 mm)  
**03-263** (200 mm)

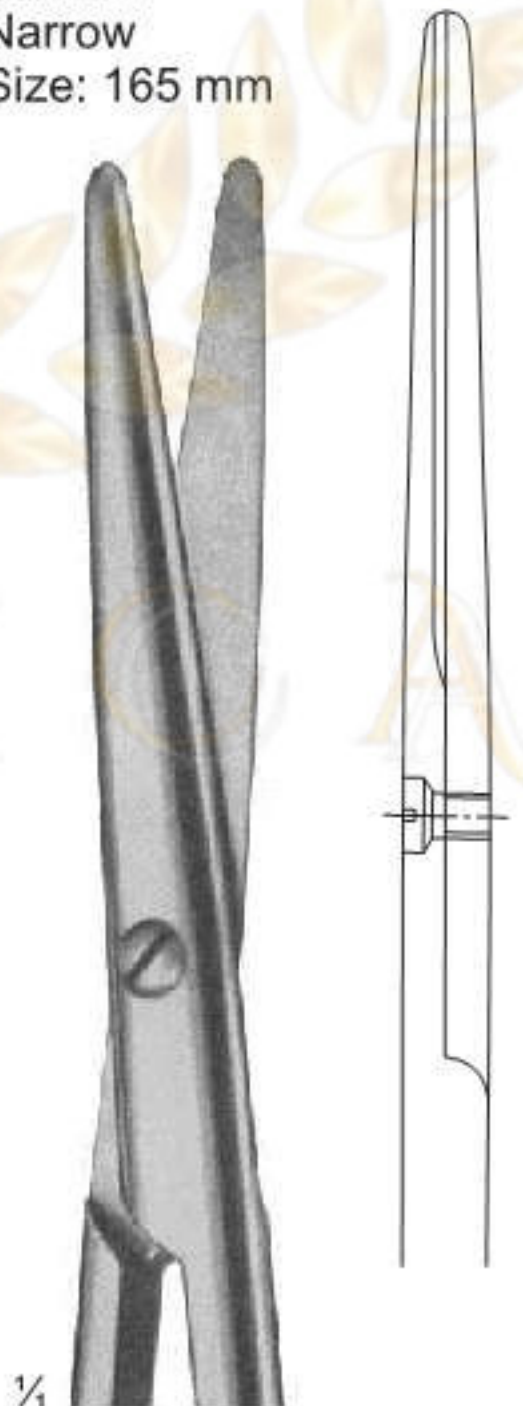

**03-262**  
Size: 165 mm

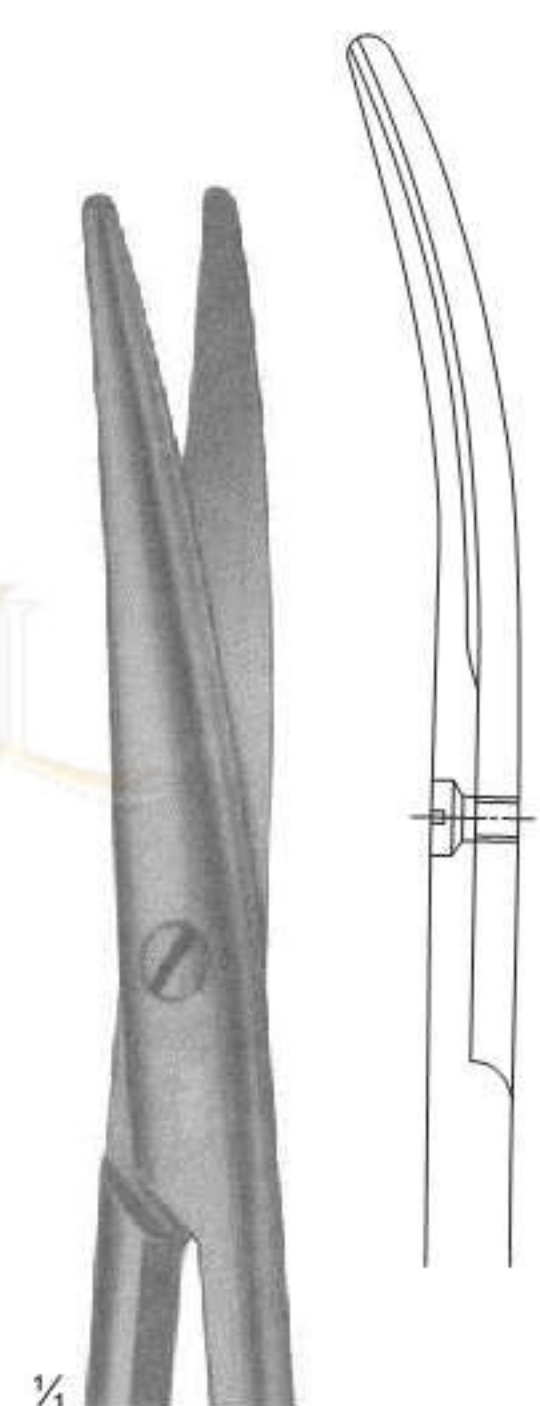

MAYO  
**03-264 - 266**  
Size: 165 mm

**03-265**  
Size: 200 mm  
**03-266**  
Size: 210 mm

# Dissecting Scissors

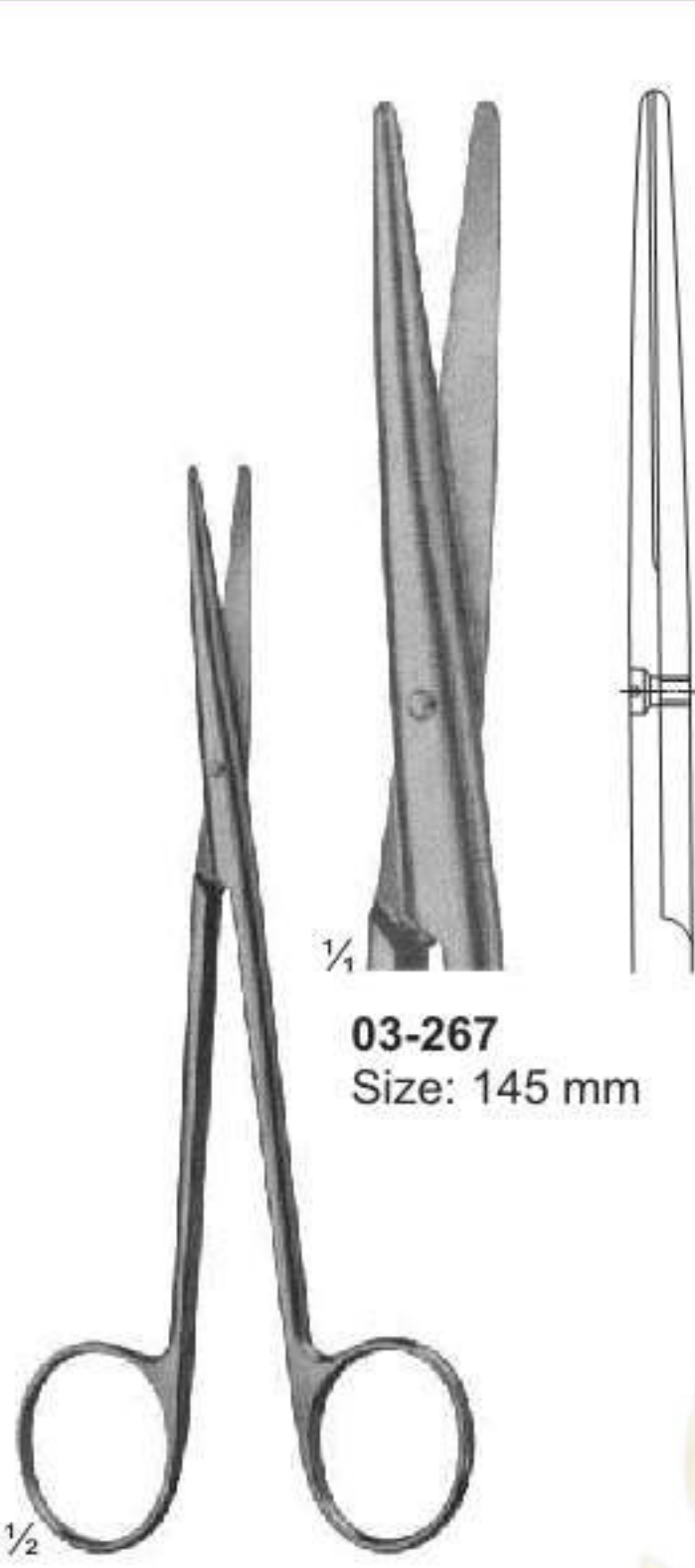

**03-267**  
Size: 145 mm

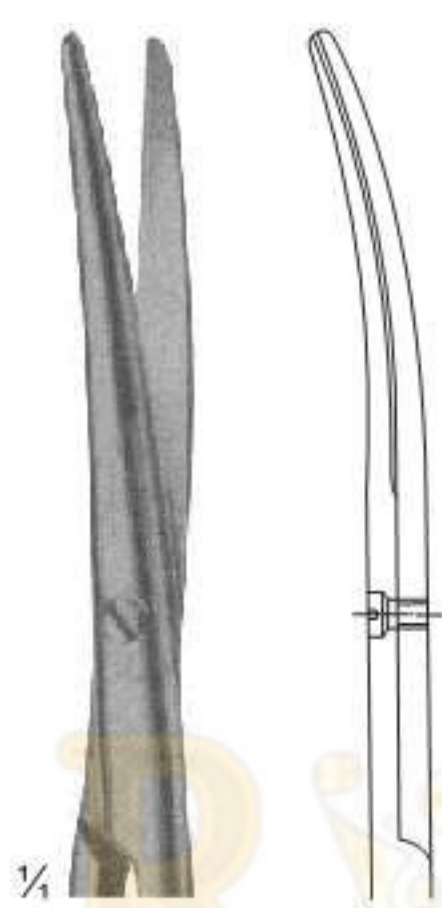

**03-268**  
Size: 145 mm

**03-267 - 268**  
BABY - METZENBAUM

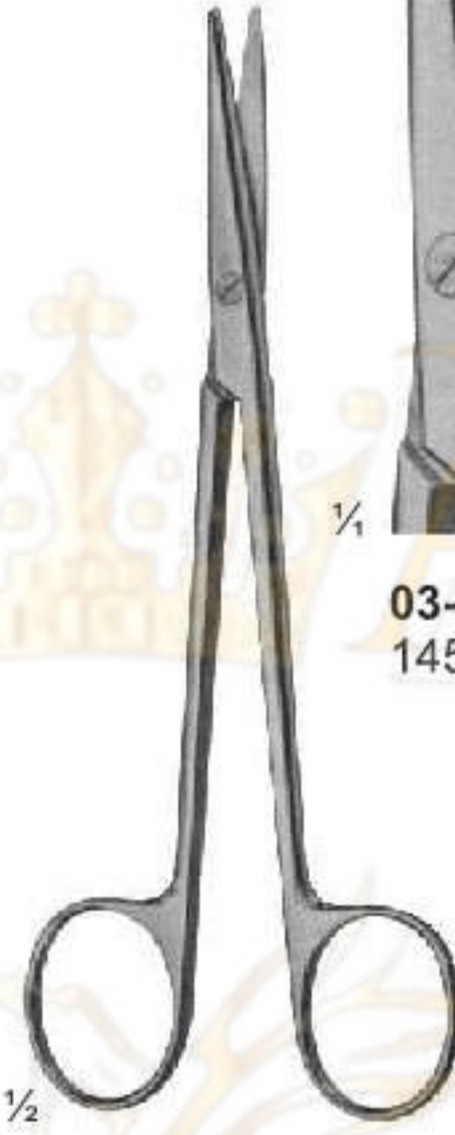

**03-269** 145 mm

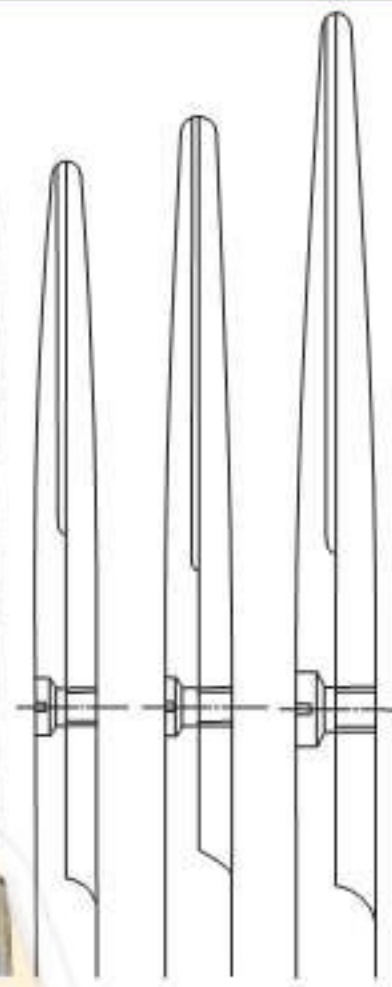

**03-270** 180 mm

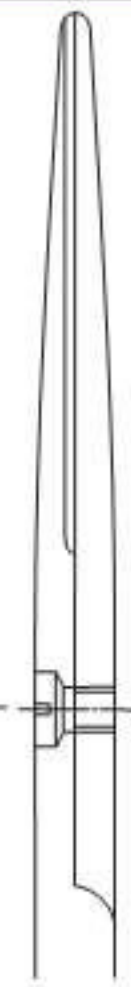

**03-271** 200 mm



**03-272** 145 mm

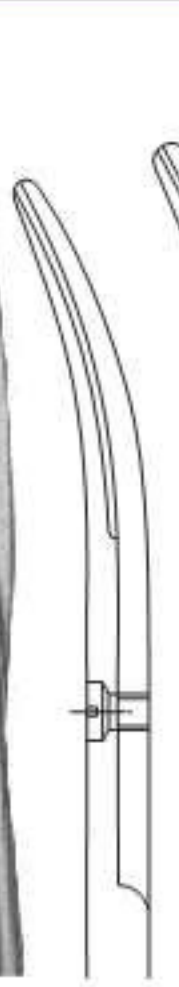

**03-273** 180 mm



**03-274** 200 mm

**03-269 - 274**  
METZENBAUM



**03-275 - 282**  
NELSON - METZENBAUM



**03-275** 230 mm

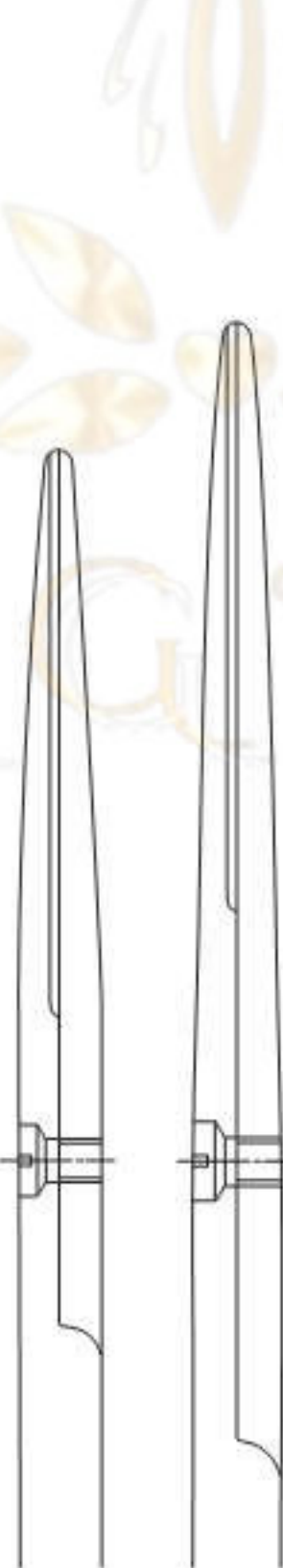

**03-276** 250 mm

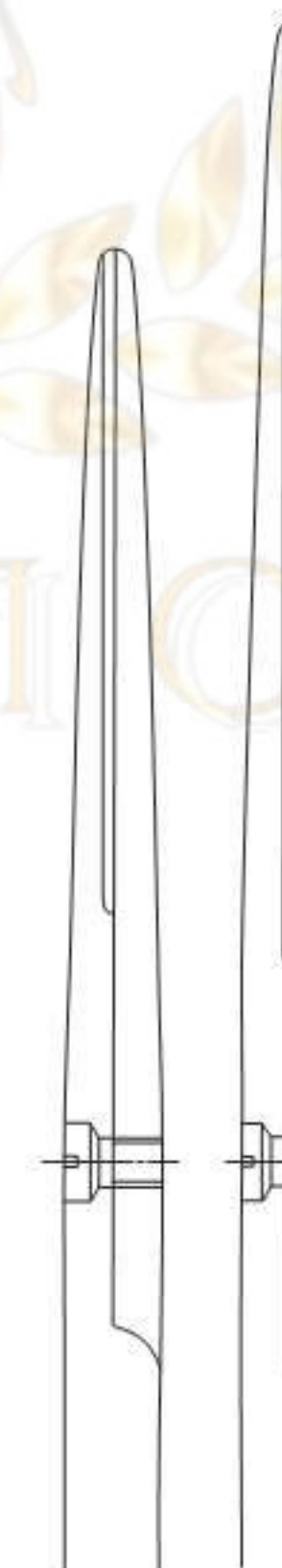

**03-277** 280 mm



**03-278** 305 mm



**03-279** 230 mm



**03-280** 250 mm

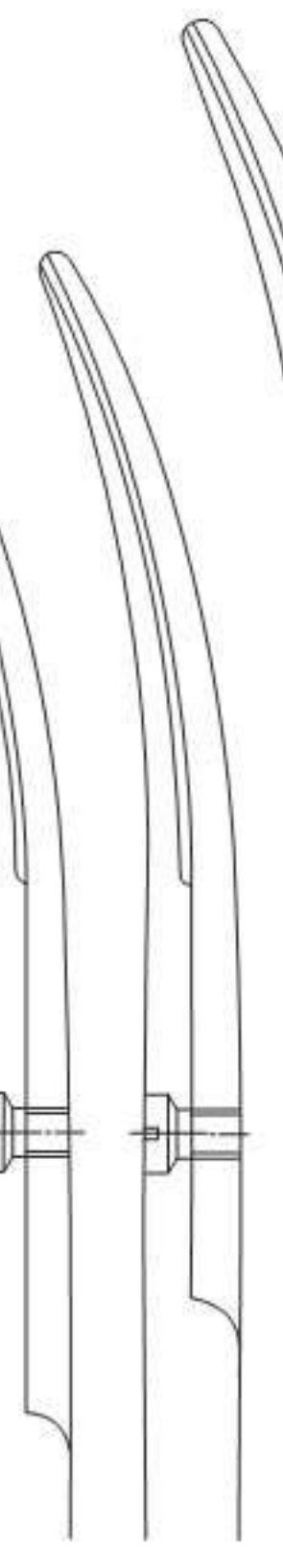

**03-281** 280 mm

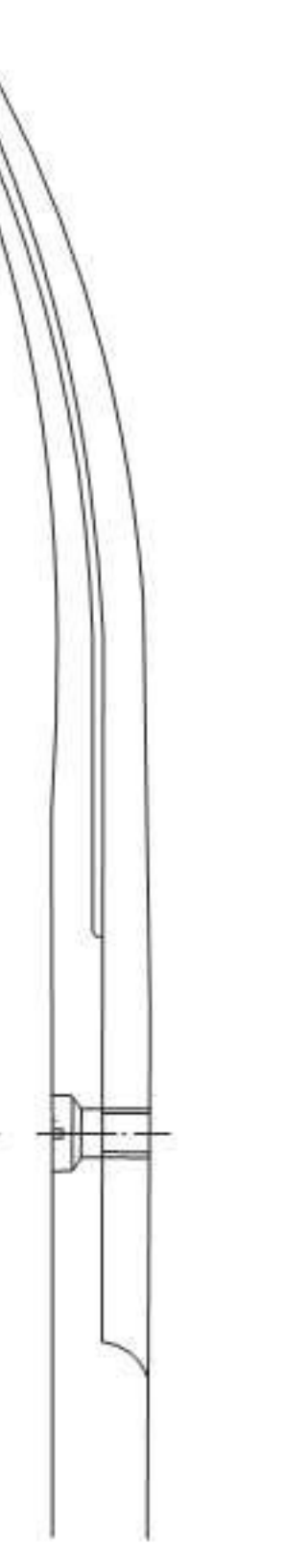

**03-282** 305 mm

# Vessel Scissors

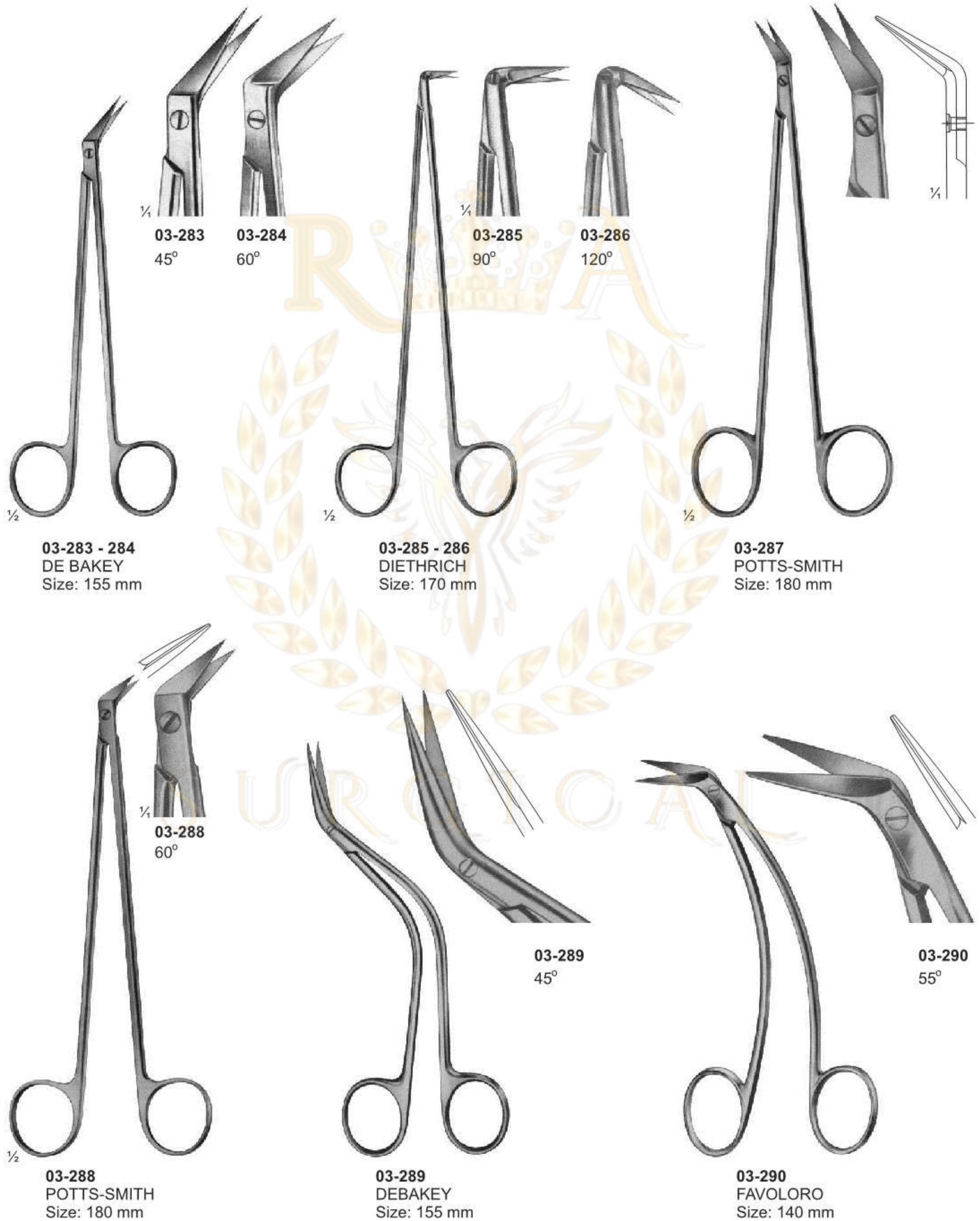

03-283  
45°

03-284  
60°

03-285  
90°

03-286  
120°

03-283 - 284  
DE BAKEY  
Size: 155 mm

03-285 - 286  
DIETRICH  
Size: 170 mm

03-287  
POTTS-SMITH  
Size: 180 mm

03-288  
60°

03-289  
45°

03-290  
55°

03-288  
POTTS-SMITH  
Size: 180 mm

03-289  
DEBAKEY  
Size: 155 mm

03-290  
FAVOLORO  
Size: 140 mm



# Cardiovascular and Neuro-Surgery Scissors



**03-291**  
OLIVECRONA  
Dura Scissors

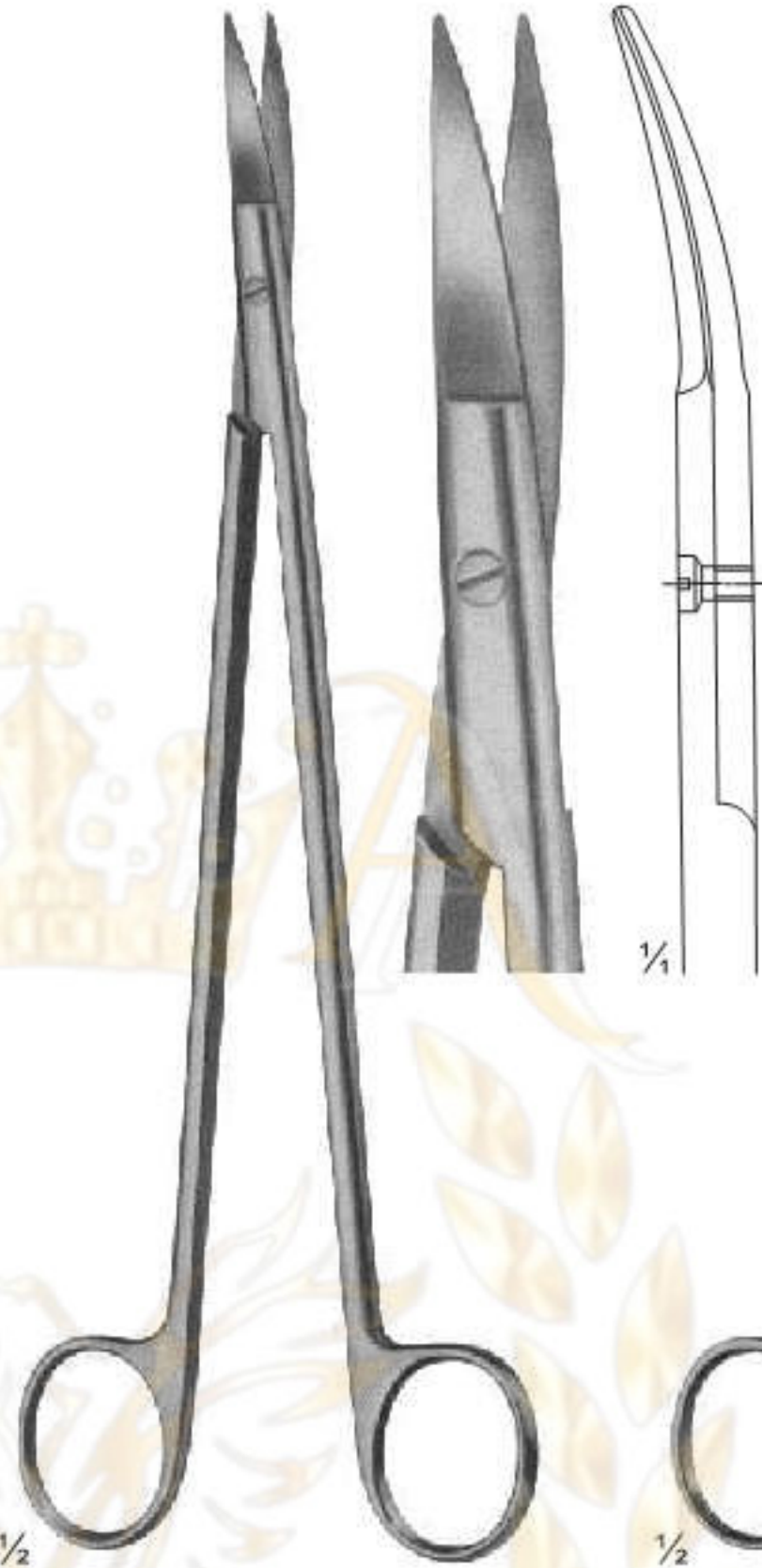

**03-292**  
STRULLY  
Pointed  
Size: 220 mm

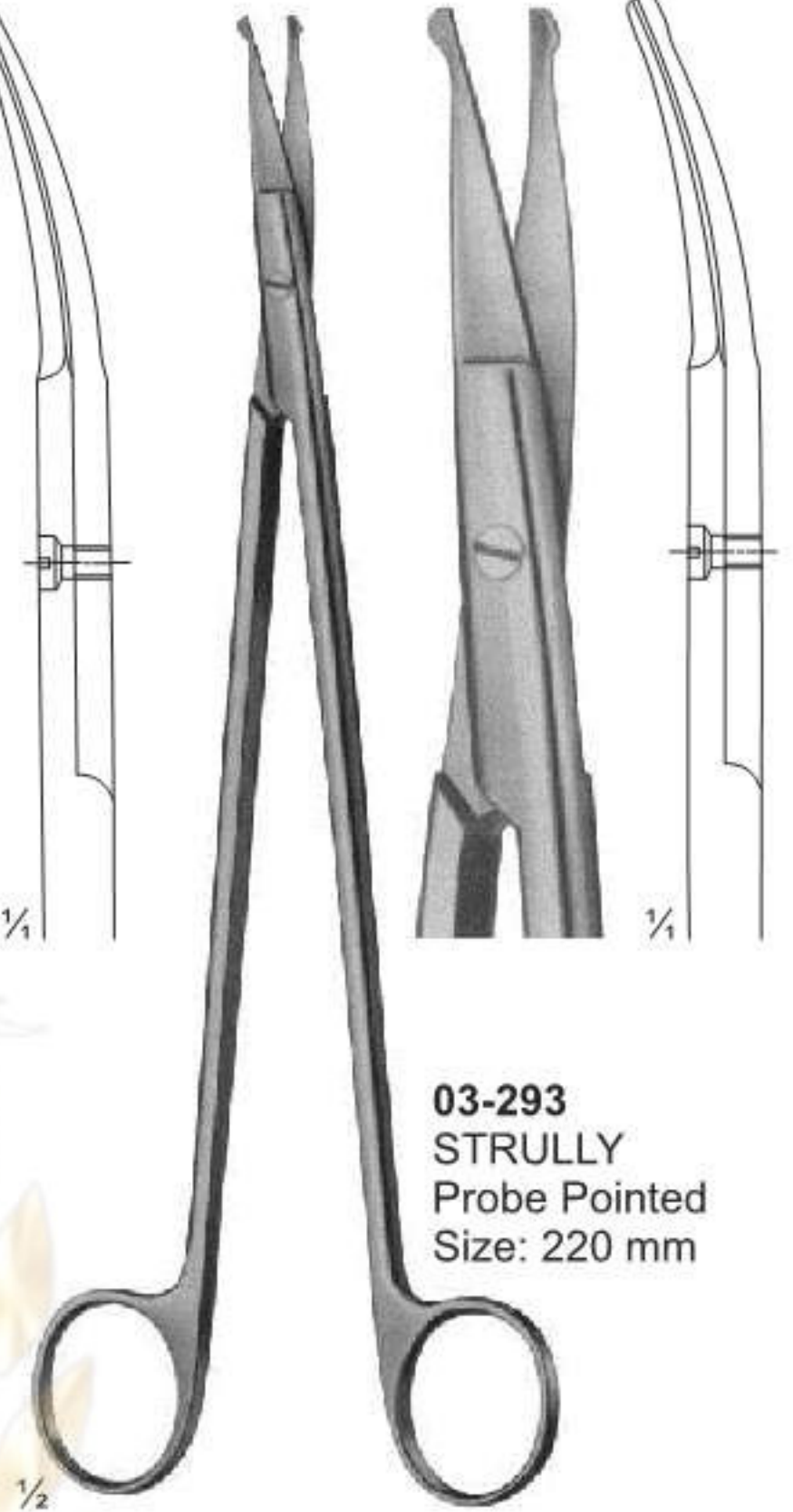

**03-293**  
STRULLY  
Probe Pointed  
Size: 220 mm

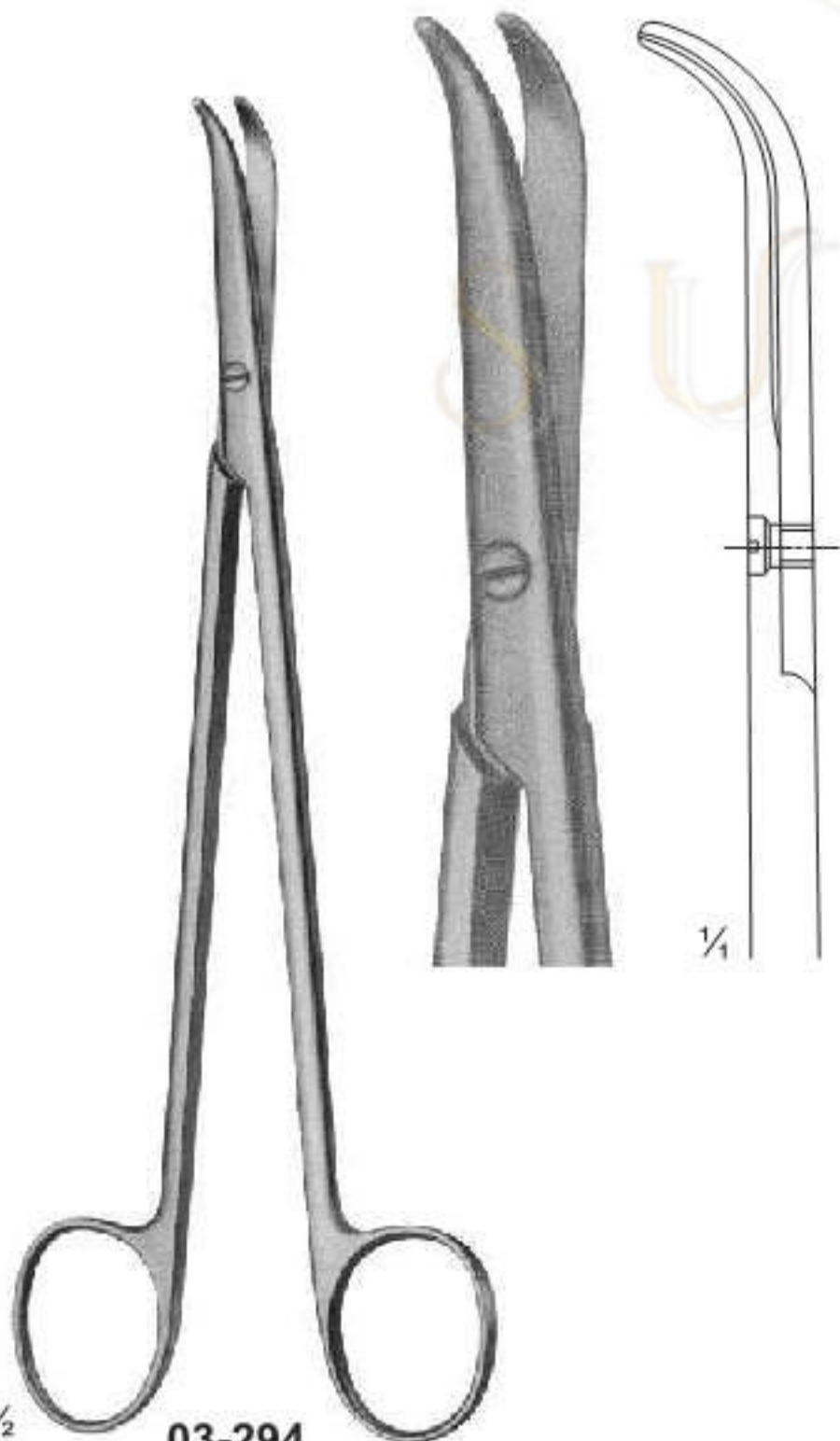

**03-294**  
THOREK  
Size: 180 mm

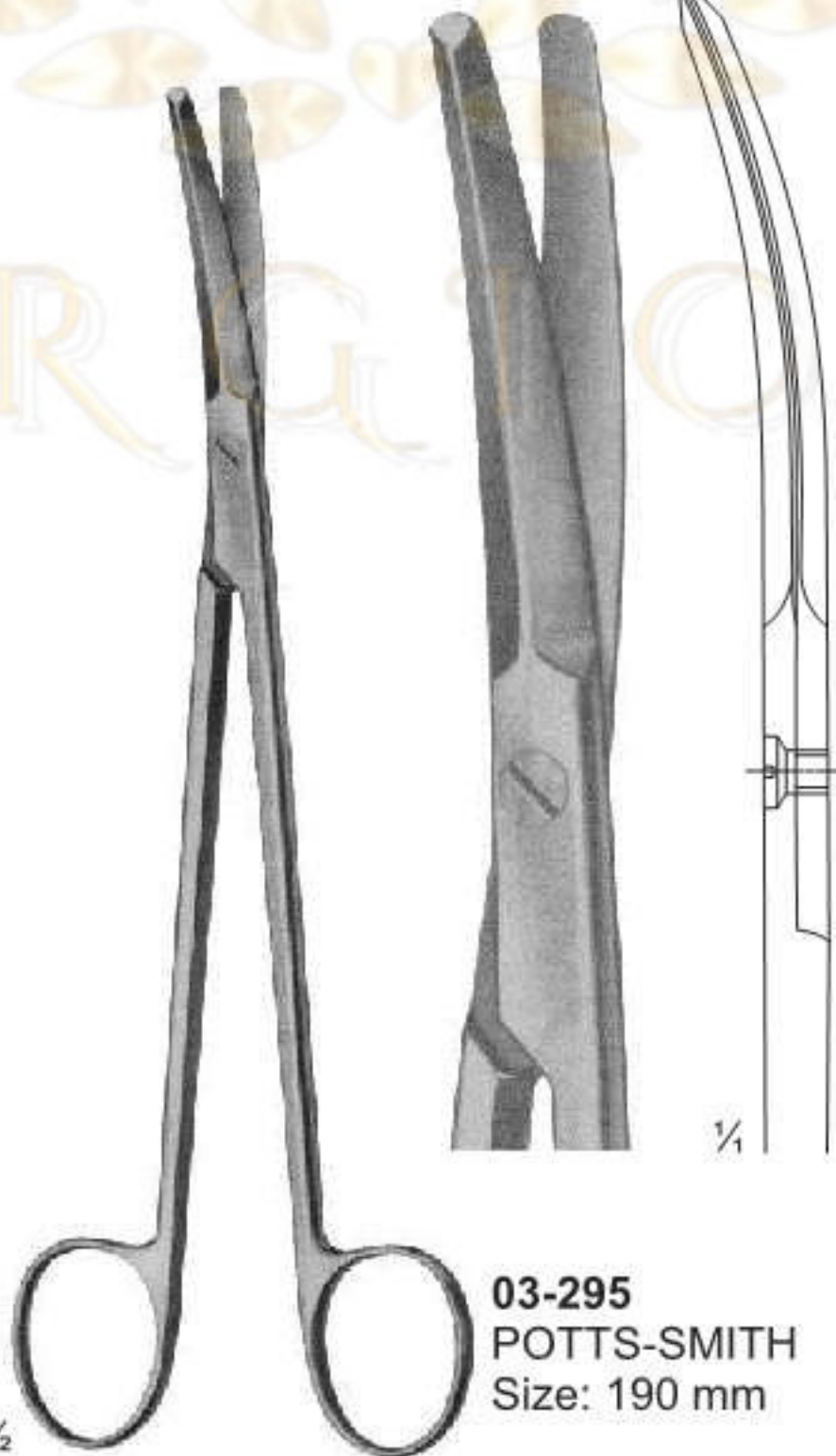

**03-295**  
POTTS-SMITH  
Size: 190 mm

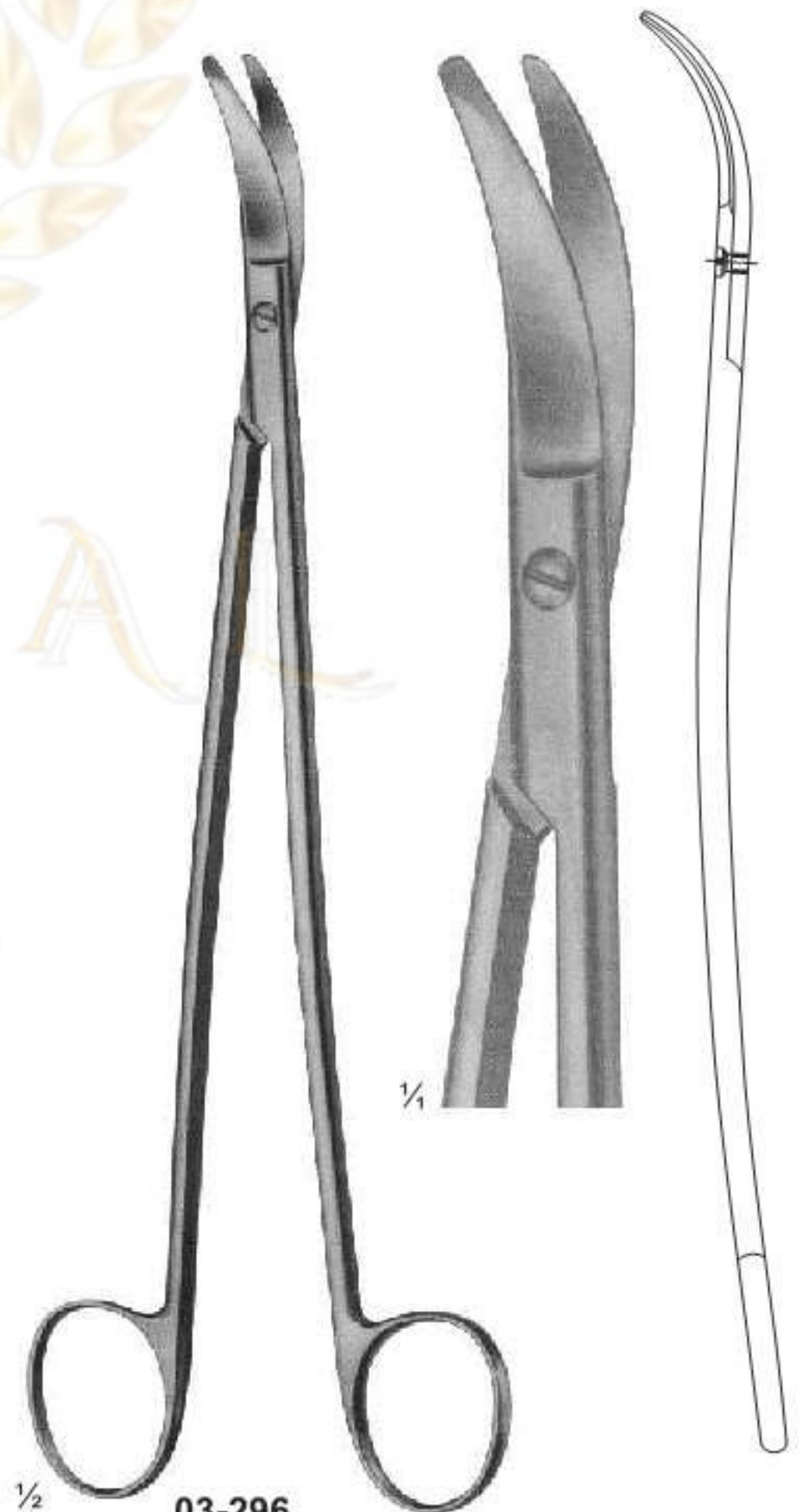

**03-296**  
SATINSKY  
Size: 245 mm

# Delicate, Nasal and Tonsil Scissors



**03-297**  
1 Finally Toothed Blade  
Size: 130 mm

**03-298**  
LOCKLIN  
Curved Sideways,  
1 Toothed Blade  
Size: 155 mm

**03-299**  
FOMON  
Blades Serrated  
Size: 145 mm

**03-300**  
COTTLE  
Size: 165 mm



**03-301**  
HEYMANN-KNIGHT  
Size: 175 mm

**03-302**  
DEAN  
Blades Serrated  
Size: 170 mm

**03-303**  
GOOD  
Size: 195 mm

# Bone Shears

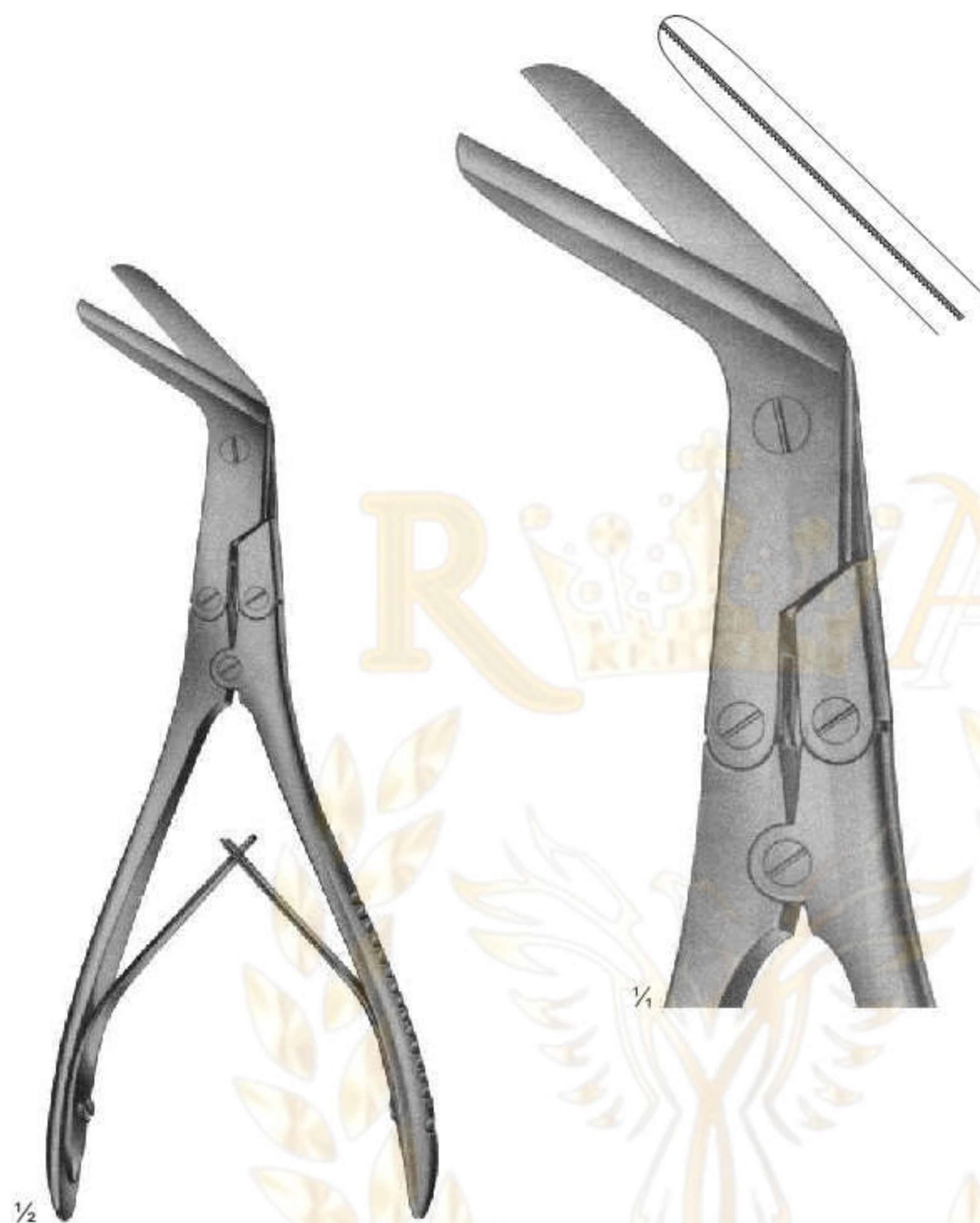

**03-304**  
KILLIAN  
Size: 200 mm



**03-305 - 306**

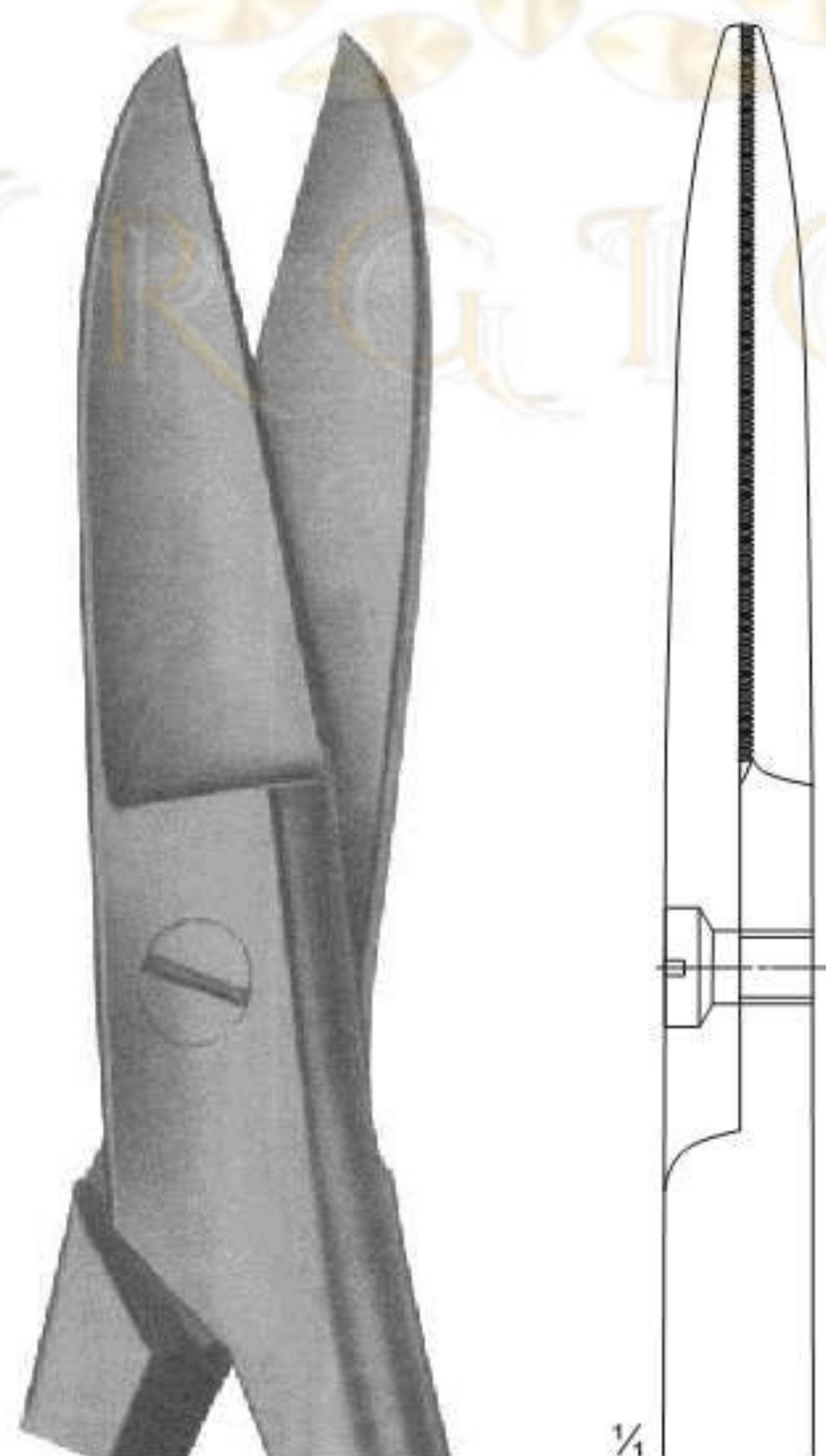

**03-305**  
195 mm

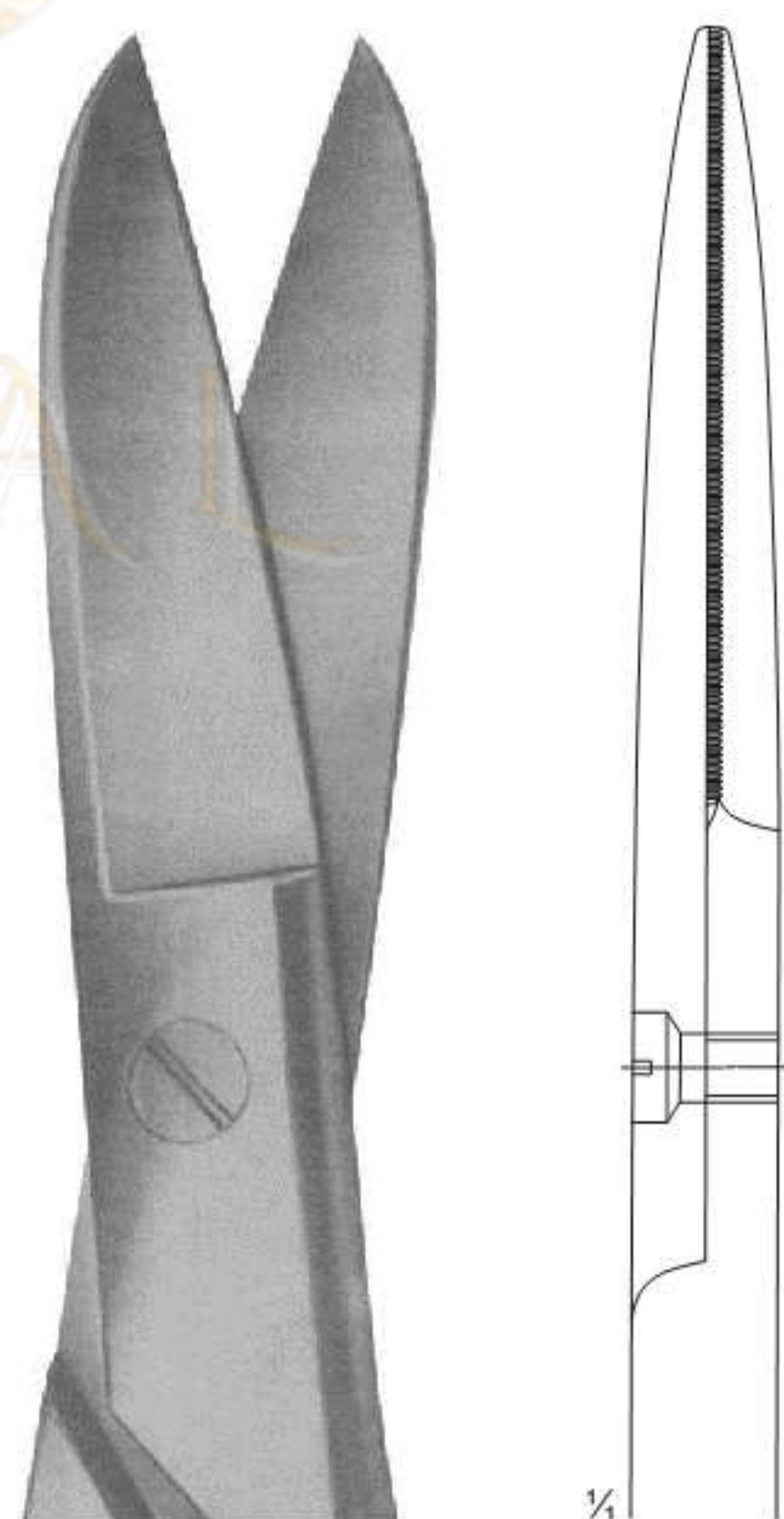

**03-306**  
225 mm

# Operating and Gynaecology Scissors

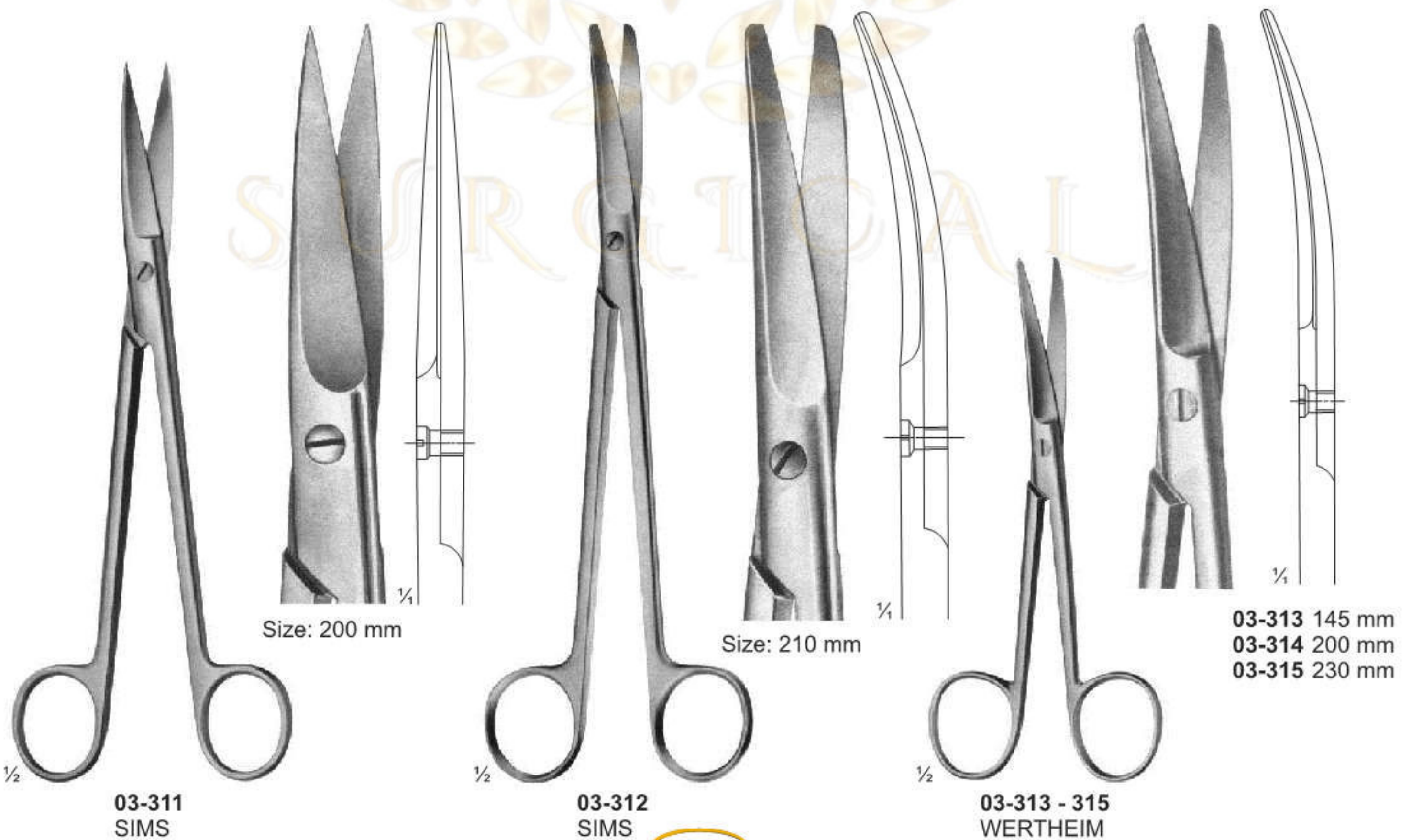
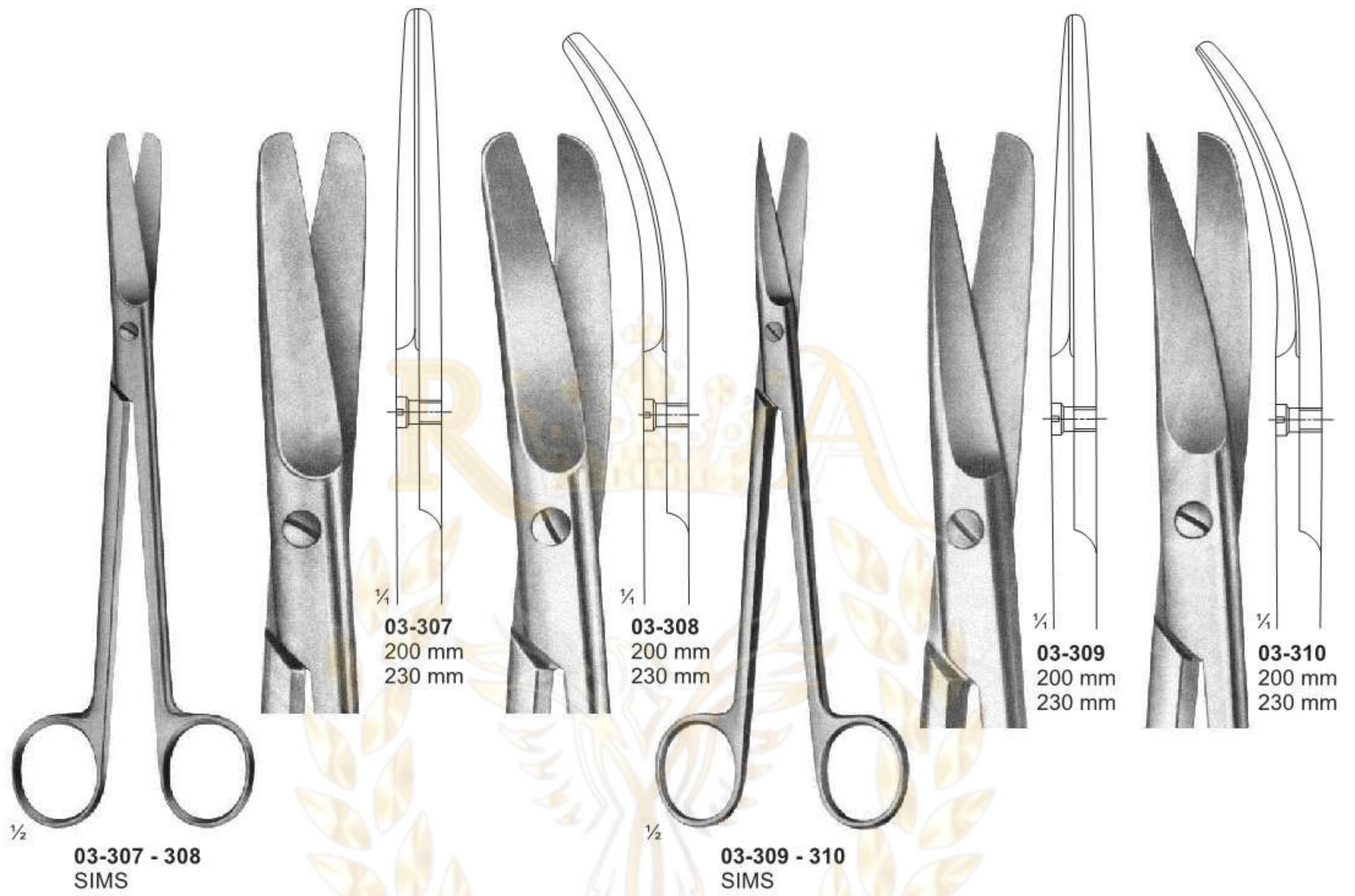

# Operating and Gynaecology Scissors



**03-316**  
SIEBOLD  
Uterine Scissors  
Size: 245 mm

**03-317**  
BOZEMANN  
Uterine Scissors  
Size: 220 mm

**03-318**  
SIMS-SIEBOLD  
Uterine Scissors  
Size: 250 mm

# Operating and Gynaecology Scissors



**03-319**  
SCHUMACHER  
Umbilical Cord Scissors  
Size: 155 mm

**03-320**  
Umbilical Cord Scissors  
Size: 105 mm

**03-321**  
Umbilical Cord Scissors

135 mm



**03-322 - 323**  
BRAUN-STADLER  
Empisiotomy Scissors

**03-322**  
145 mm

**03-323**  
200 mm

**03-324**  
DAMMSCHERE  
Empisiotomy Scissors  
240 mm

# Bowel Scissors, Cartilage Scissors



**03-325**  
DAMMSCHERE  
Bowel Scissors  
Size: 210 mm

**03-326**  
DAMMSCHERE  
Bowel Scissors  
Size: 210 mm

**03-327**  
LLOYD-DAVIES  
(GOLIGHER'S)  
Rectal Scissors  
Size: 255 mm

**03-328**  
STELZNER  
Rectal Scissors  
Size: 310 mm

# Ligature Scissors

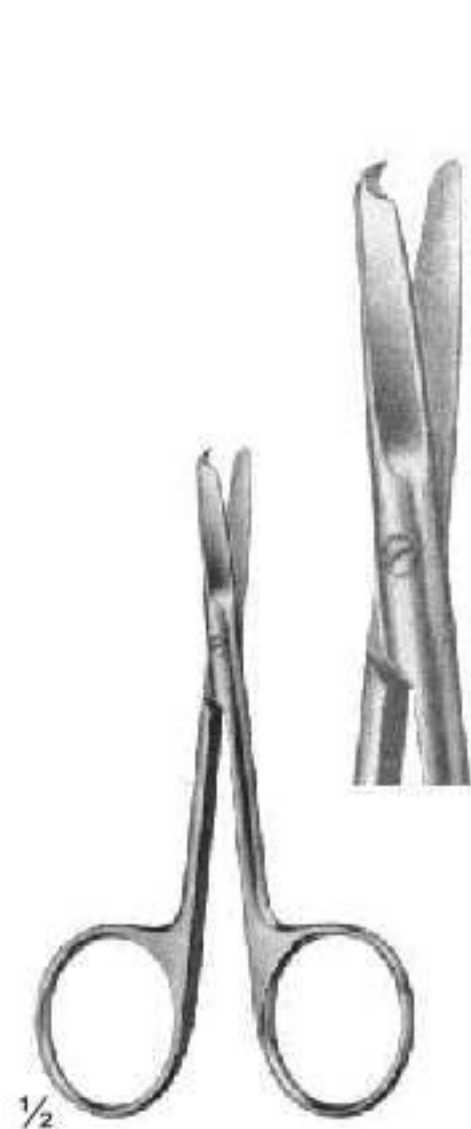

**03-329 - 330**  
SPENCER

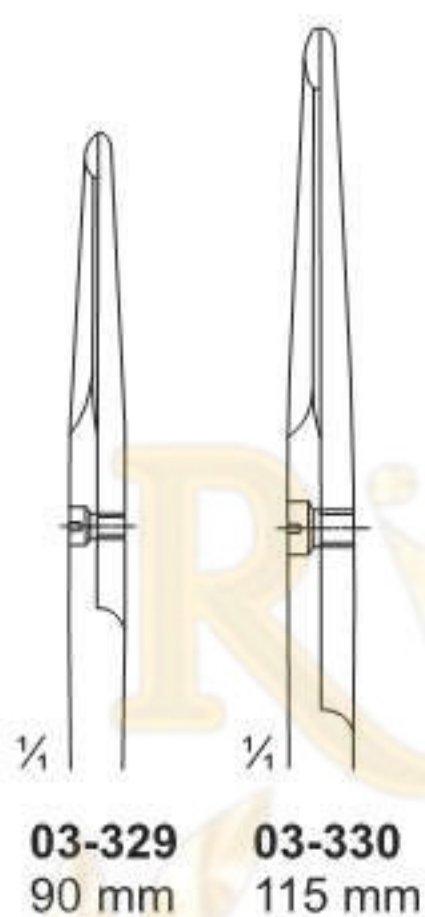

**03-329** 90 mm  
**03-330** 115 mm

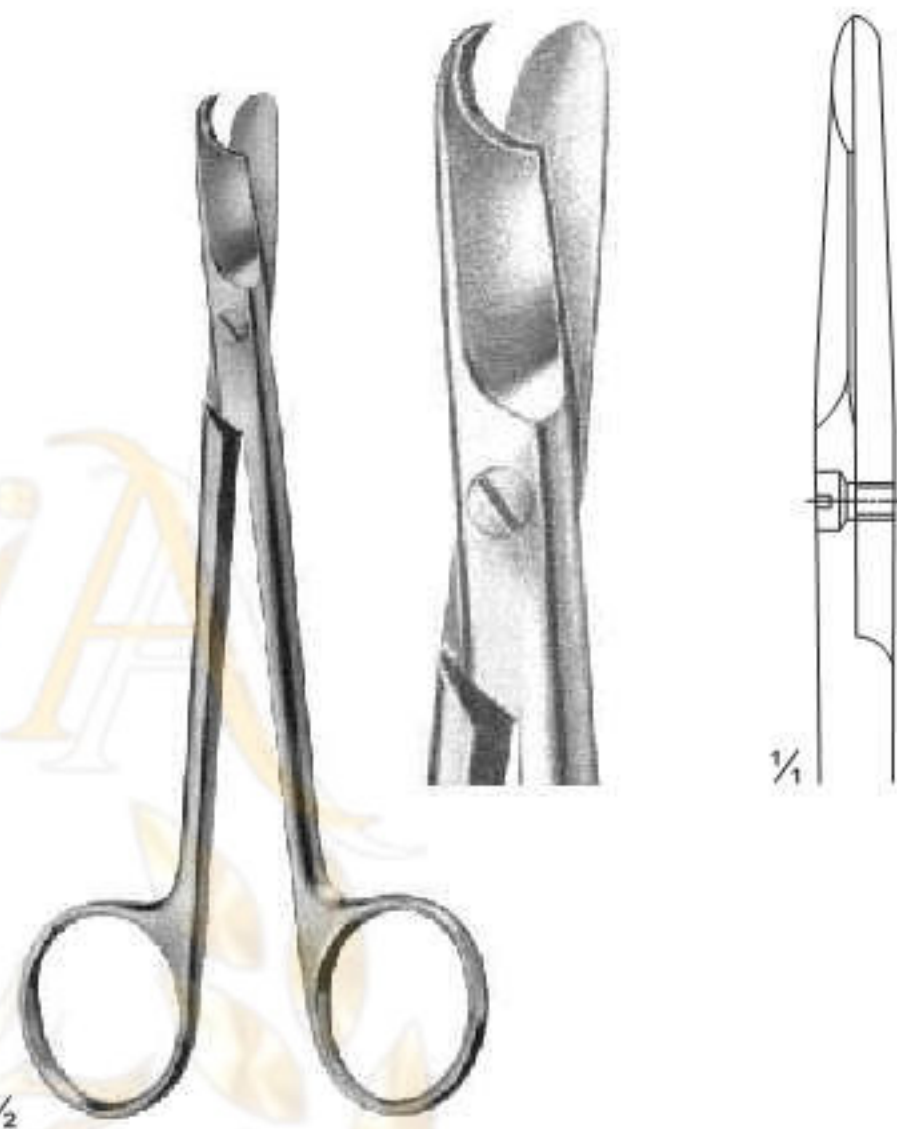

**03-331**  
LITTAUER  
Size: 135 mm

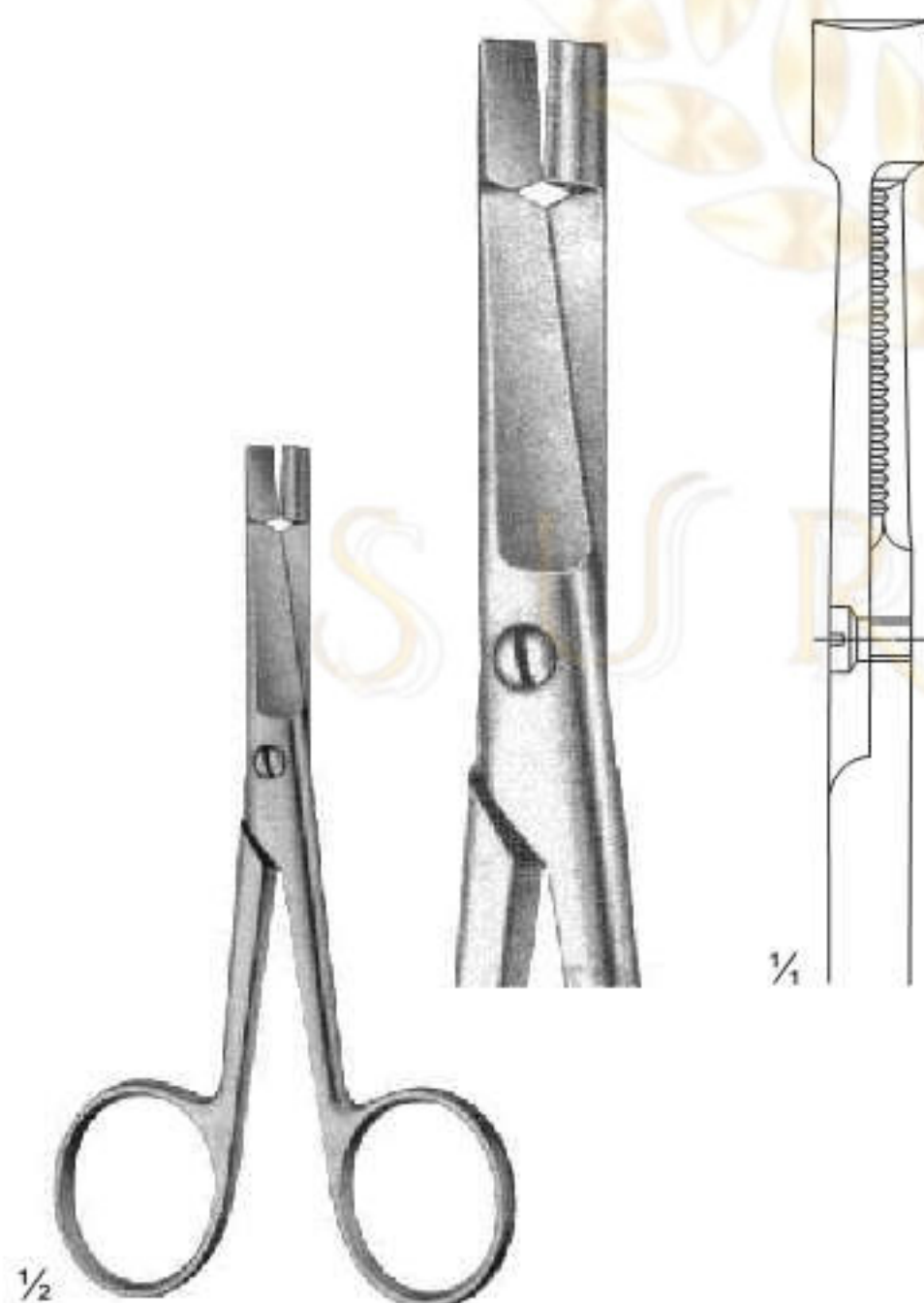

**03-332**  
EISELSBERG  
Size: 115 mm



**03-333**  
SCHOEMAKER-LOTH  
Size: 125 mm



# Wire and Plate Scissors

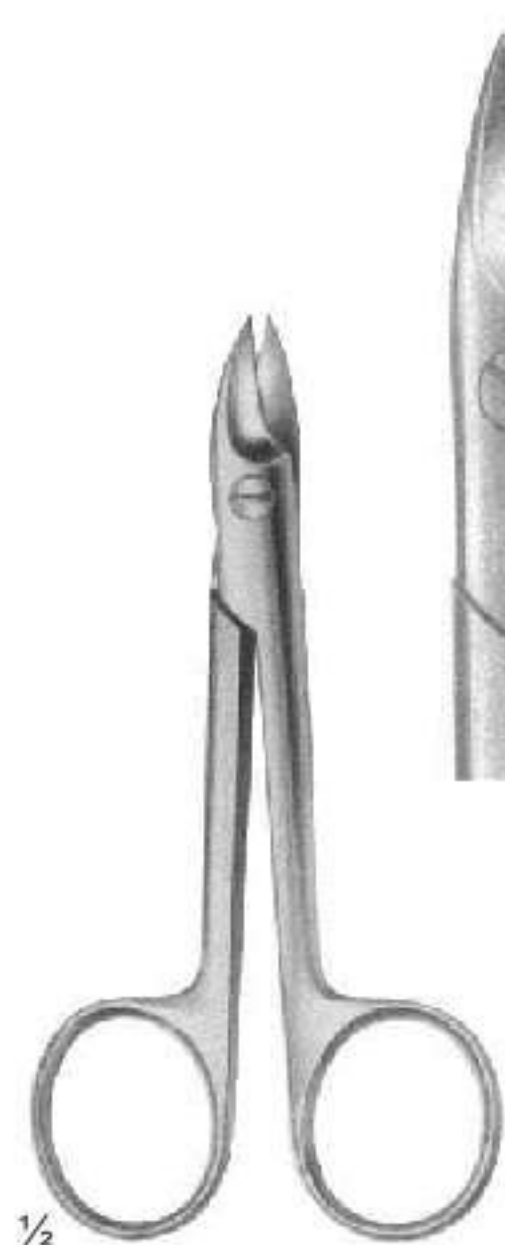

**03-334 - 338**  
BEEBE  
Size: 110 mm

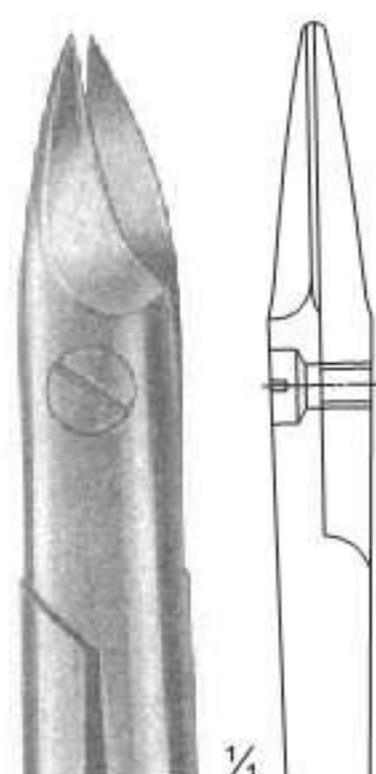

**03-334**

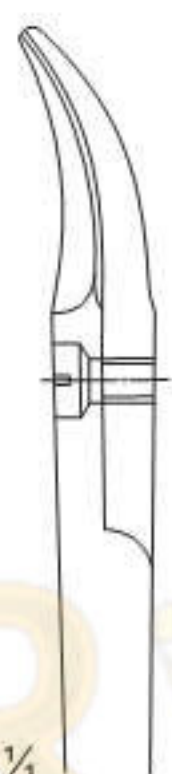

**03-335**

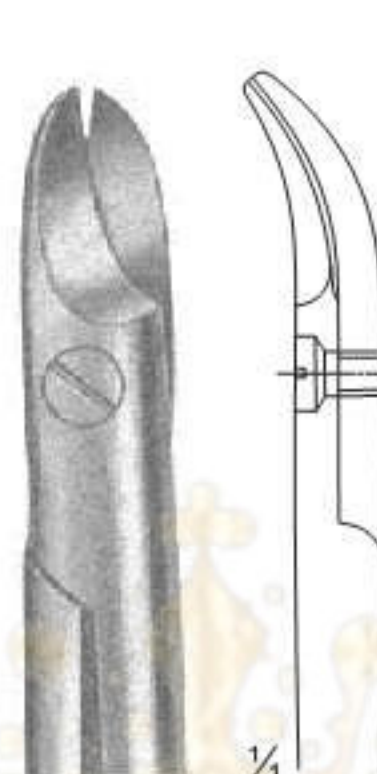

**03-336**  
Broad Blades

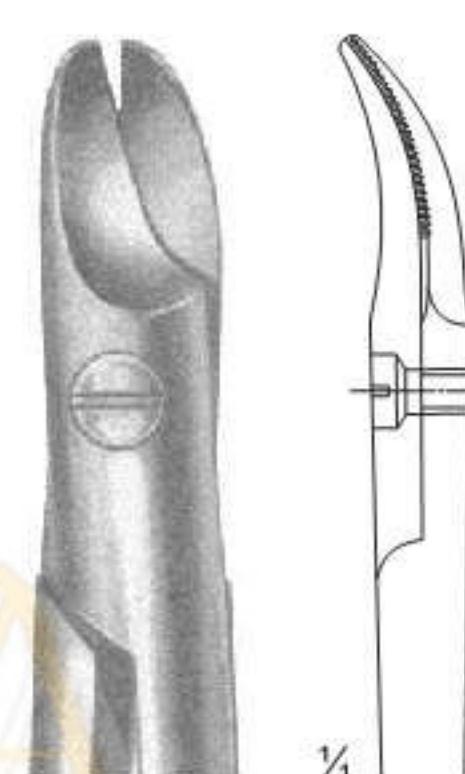

**03-337**  
1 Blade Serrated

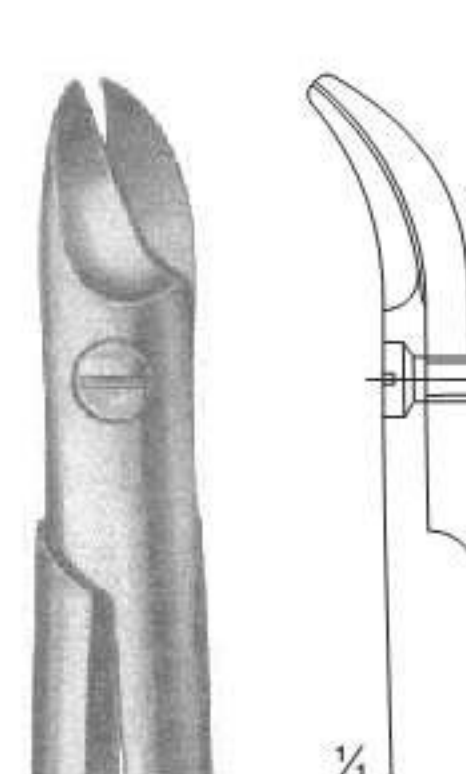

**03-338**  
NAUJOKS  
Strongly Curved

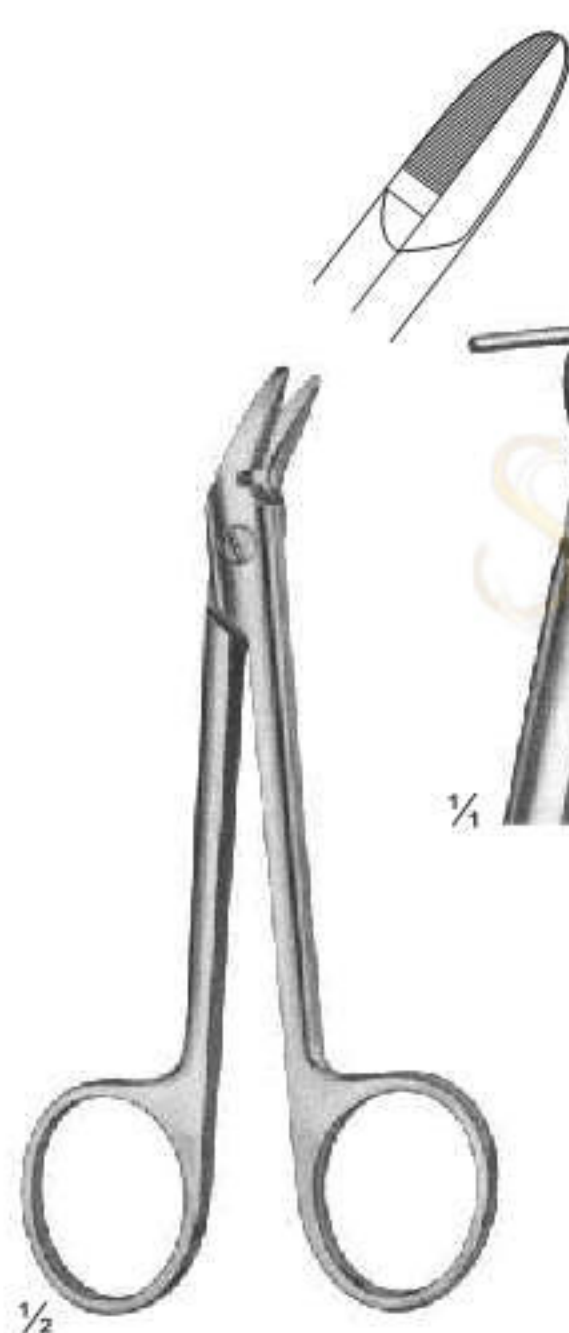

**03-339**  
1 Blade Serrated  
Size: 120 mm

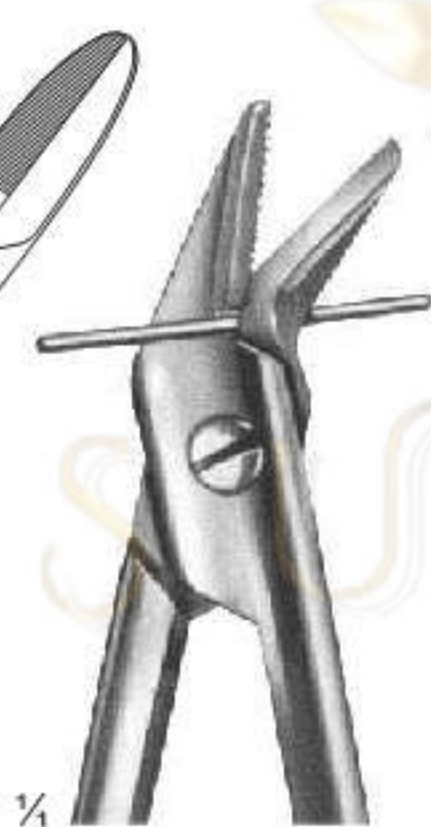

**03-340**  
STRACK  
Size: 100 mm



**03-341**  
HARVEY  
Size: 125 mm

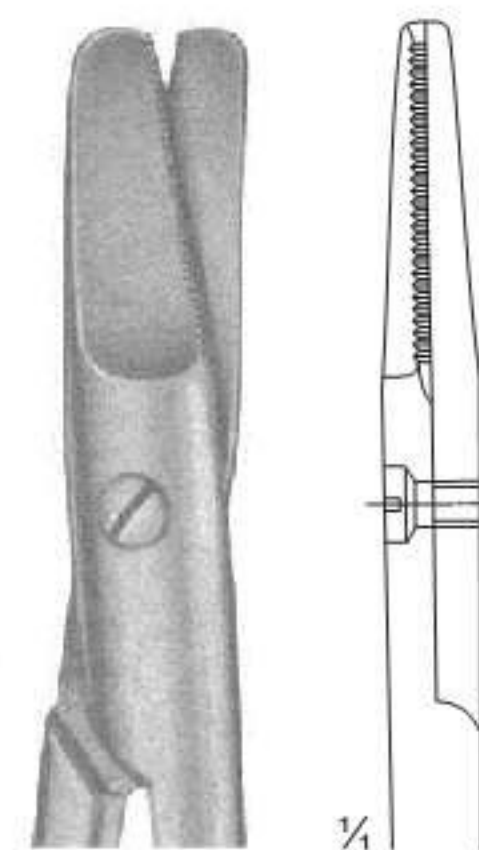

# Wire and Plate Scissors



# Bandage and Cloth Scissors



**03-352**  
UNIVERSAL AND BANDAGE SCISSORS  
180 mm



**03-353**  
LISTER  
Size: 145 mm

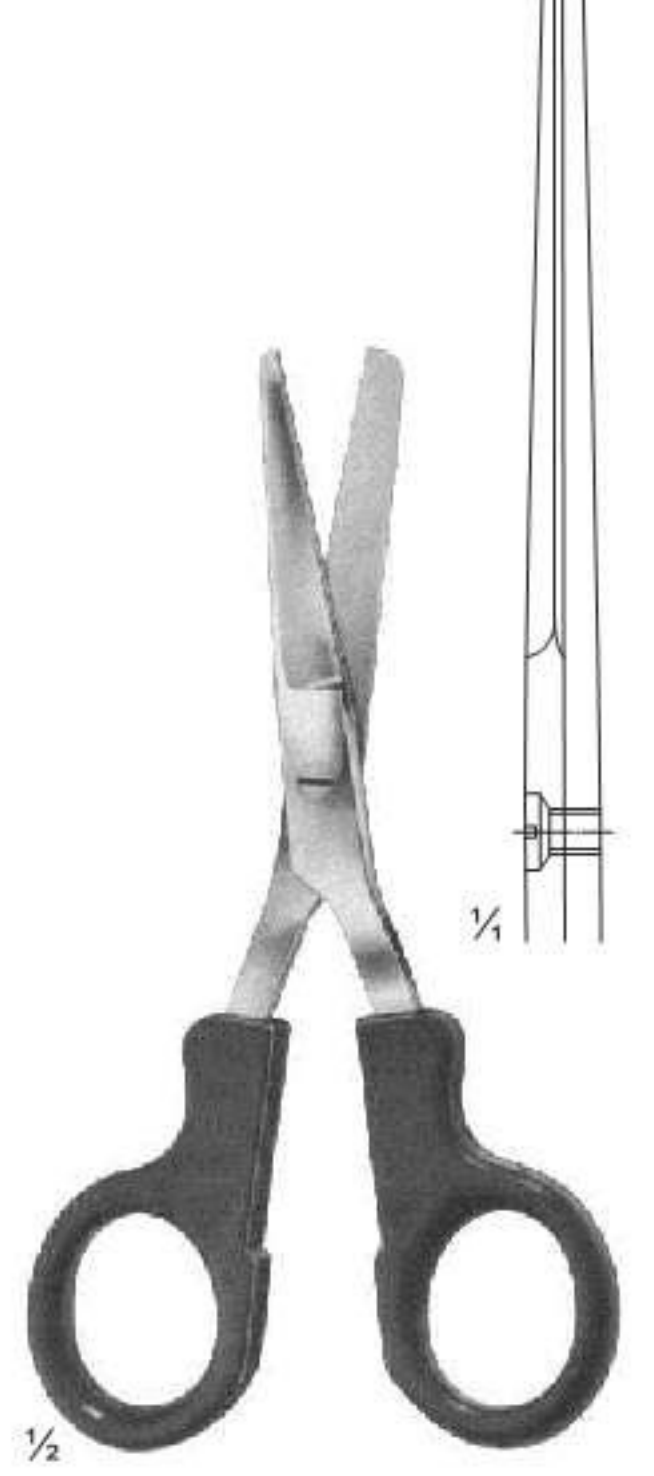

**03-354**  
LISTER  
Size: 145 mm



**03-355 - 358**  
LISTER



**03-355**  
115 mm  
**03-356**  
140 mm  
**03-357**  
180 mm  
**03-358**  
200 mm



**03-359 - 360**  
LISTER

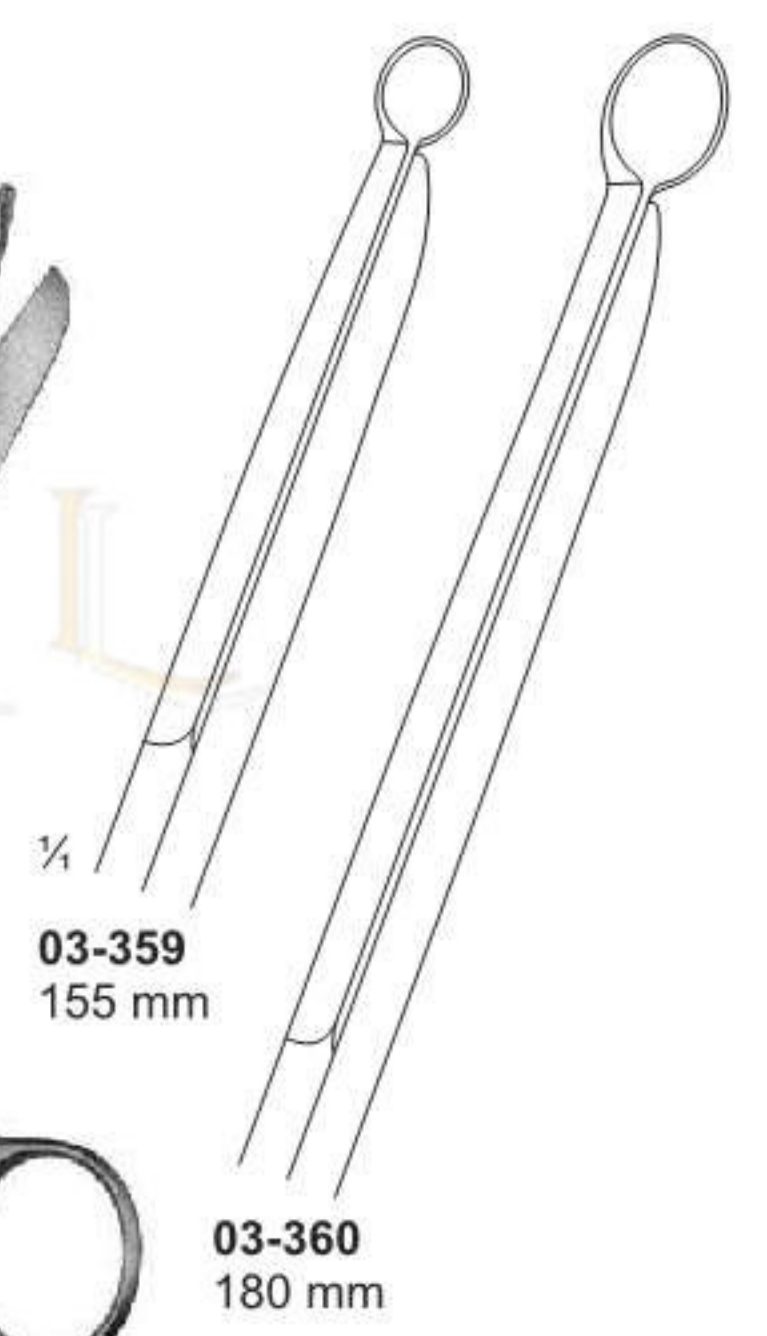

**03-359**  
155 mm  
**03-360**  
180 mm

# Bandage, Cloth and Plaster Scissors

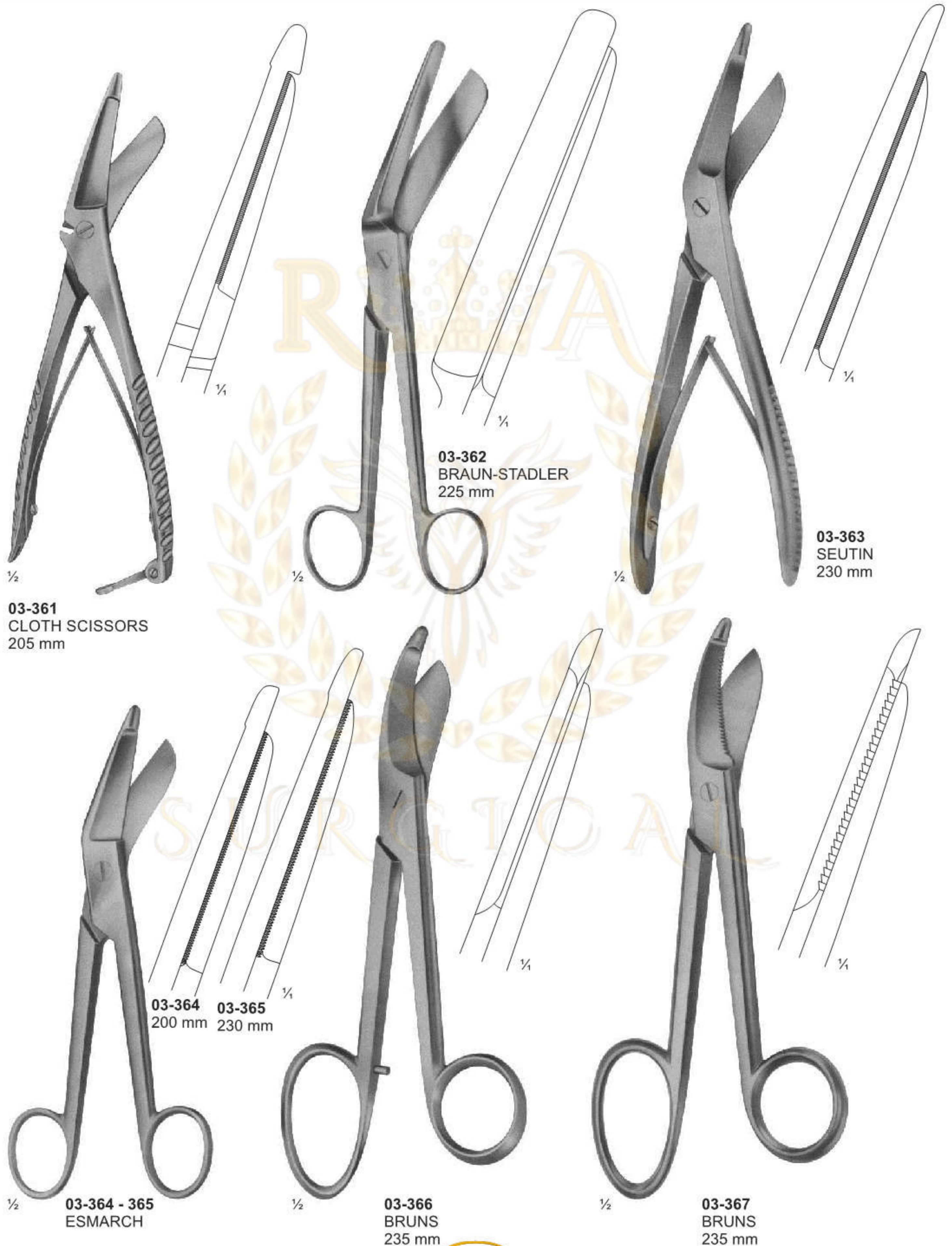

**03-361**  
CLOTH SCISSORS  
205 mm

**03-362**  
BRAUN-STADLER  
225 mm

**03-363**  
SEUTIN  
230 mm

**03-364** 200 mm  
**03-365** 230 mm

**03-364 - 365**  
ESMARCH

**03-366**  
BRUNS  
235 mm

**03-367**  
BRUNS  
235 mm



# Ligature Forceps, Micro Forceps (Light Patterns)



# Forceps for Grasping Tissue, Tumors

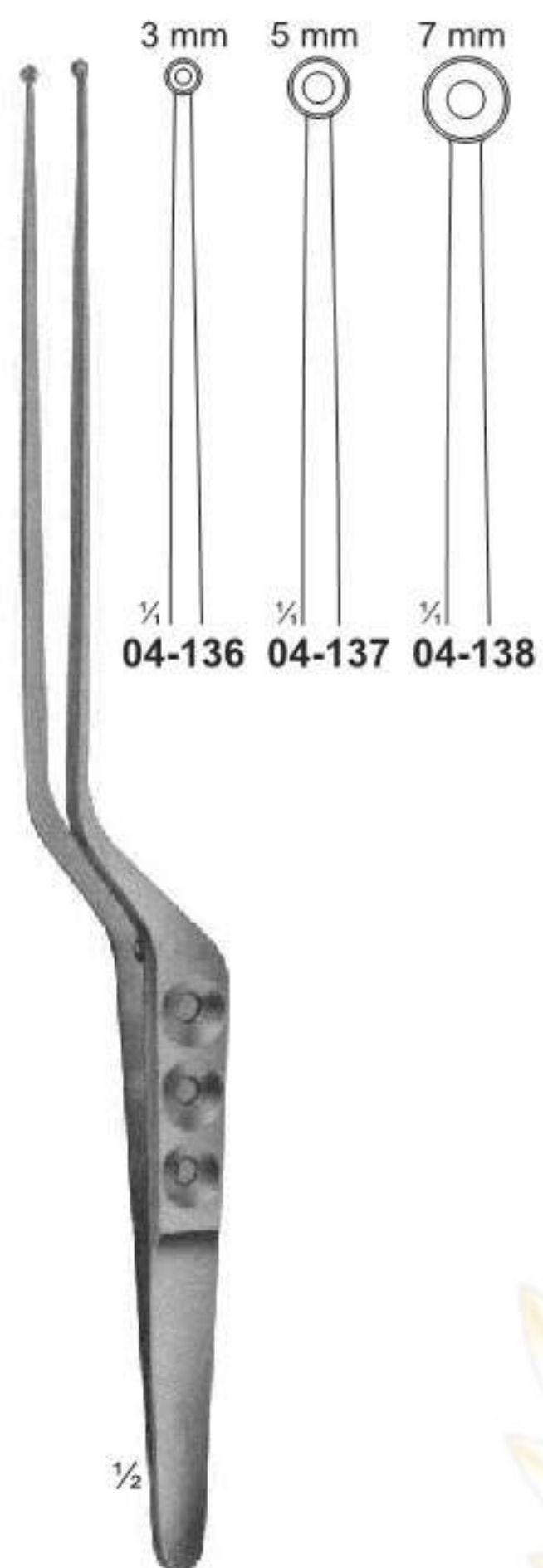

**04-136 - 138**  
YASARGIL-SAMI  
Jaws Spoon-Shaped  
240 mm

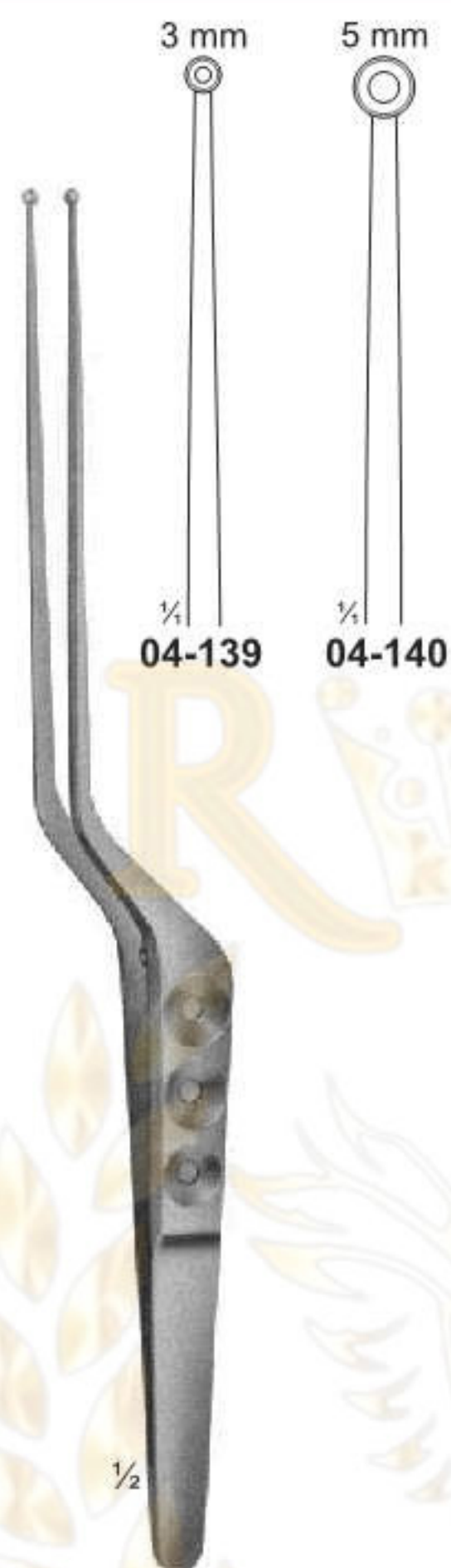

**04-139 - 140**  
YASARGIL  
Jaws Spoon-Shaped  
220 mm



**04-141 - 143**  
SAMII  
Jaws Spoon-Shaped  
230 mm

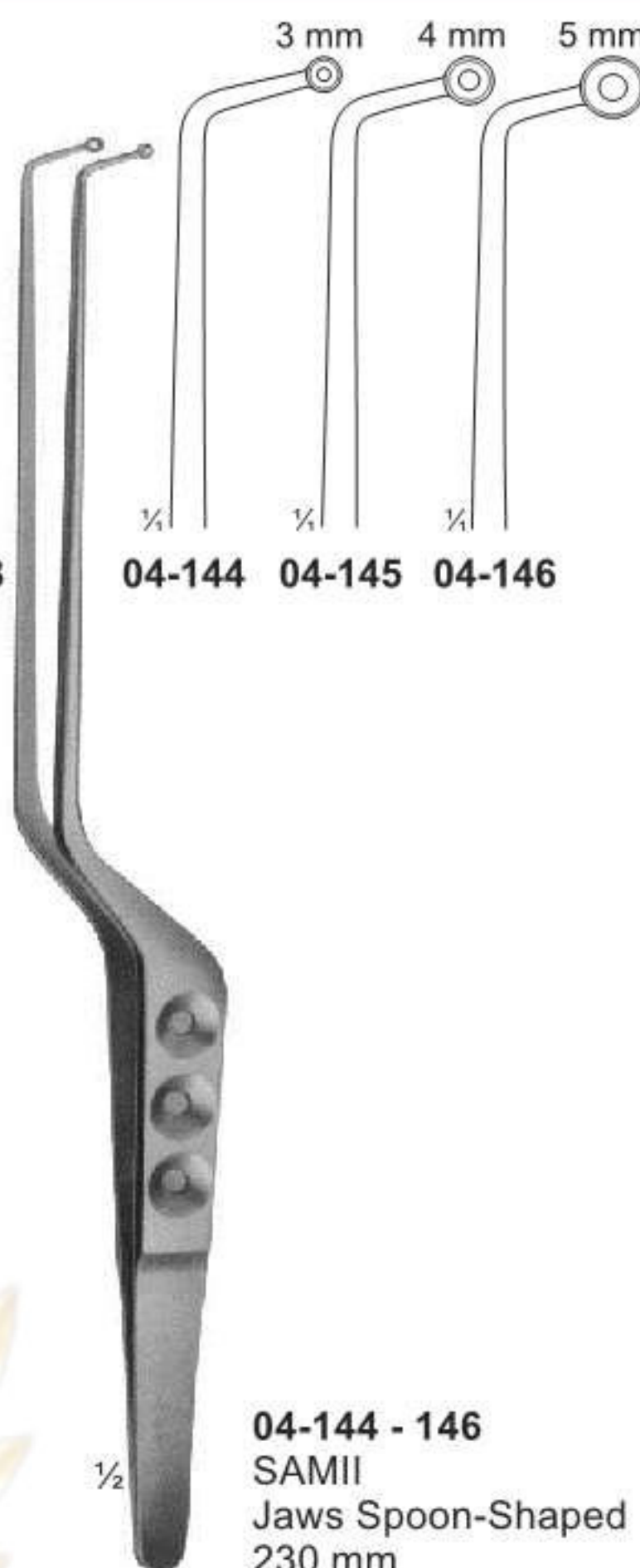

**04-144 - 146**  
SAMII  
Jaws Spoon-Shaped  
230 mm



**04-147**  
HUNT  
Tumor-and Vessel Forceps  
200 mm



**04-148**  
HUNT  
Tumor-and Vessel Forceps  
200 mm



**04-149**  
YASARGIL  
Tumor-and Vessel Forceps  
200 mm

# Delicate Dissecting, Microscopic, Sterilizing Forceps



**04-150**  
**THORPE**  
 Corneal Forceps  
 120 mm

**04-151**  
**MICRO-ADSON**  
 120 mm

**04-152**  
**ADSON**  
 120 mm

**04-153**  
**MICRO-ADSON**  
 150 mm

**04-154 - 156**  
 100 mm

**04-157**  
 110 mm

**04-158**  
 115 mm

**04-159 - 168**

**04-159** 90 mm   **04-160** 105 mm   **04-161** 115 mm   **04-162** 130 mm   **04-163** 145 mm   **04-164** 90 mm   **04-165** 105 mm   **04-166** 115 mm   **04-167** 130 mm   **04-168** 145 mm

**04-169**  
 100 mm

**04-170**  
 100 mm

**04-171**  
 100 mm

**04-172**  
**COVER GLASS FORCEPS**  
 105 mm

**04-173**  
 160 mm



# Delicate Dissecting Forceps

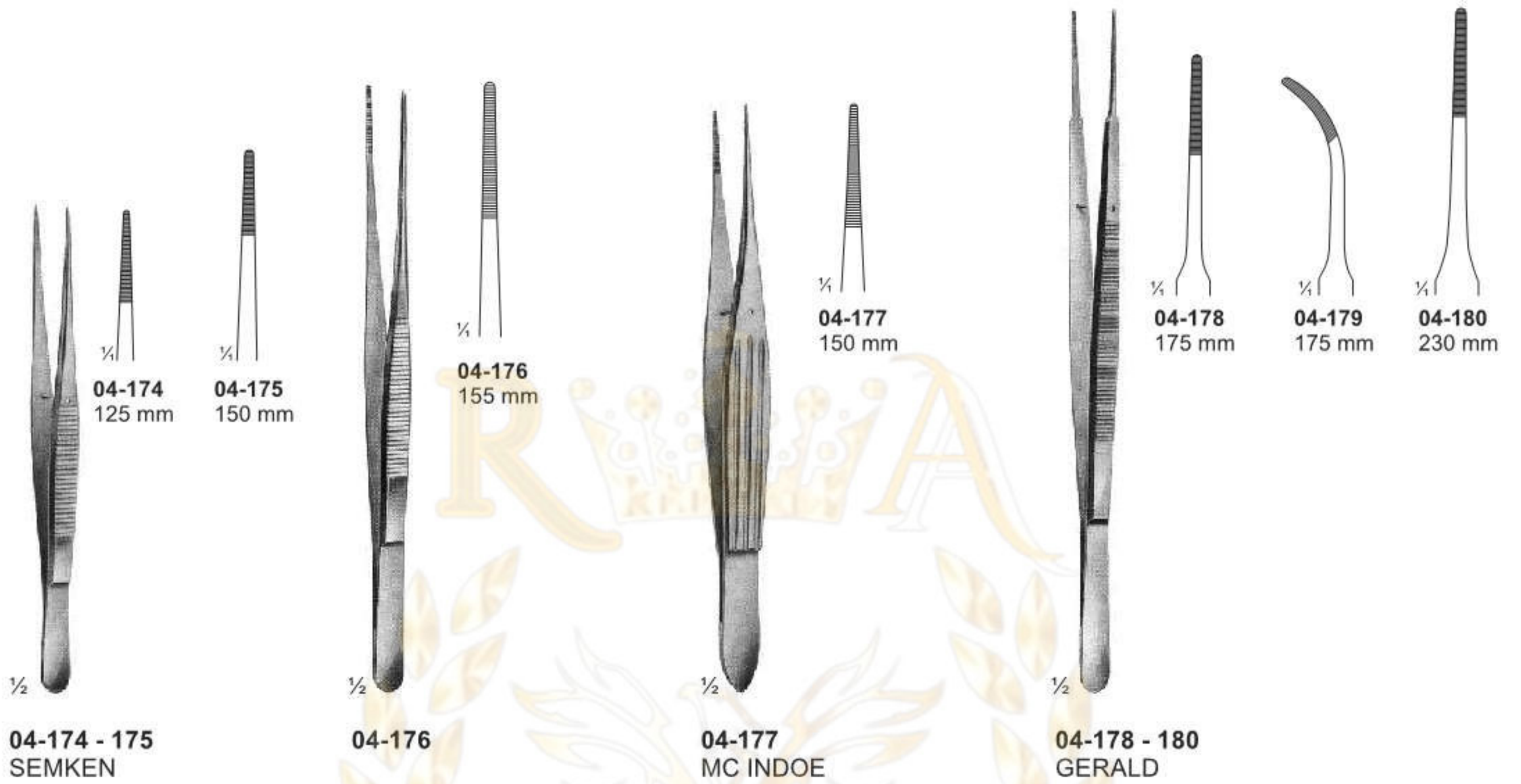

# Dissecting Forceps



04-190 - 197  
STANDARD



04-198 - 202  
MEDIUM



04-203 - 204  
MEDIUM

# Dissecting Forceps



04-205 - 206



04-207 - 210

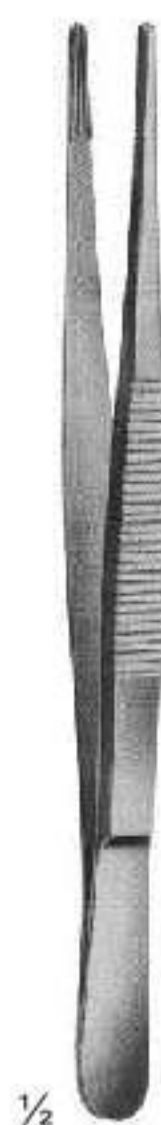

**04-211**  
OCHSNER



**04-212**  
FRICKE



**04-213**  
BONNEY



# Ultra-Light Forceps



**04-214**  
150 mm



1.2 mm



**04-215**  
200 mm



1.5 mm



**04-216**  
240 mm



1.5 mm



**04-217**  
300 mm

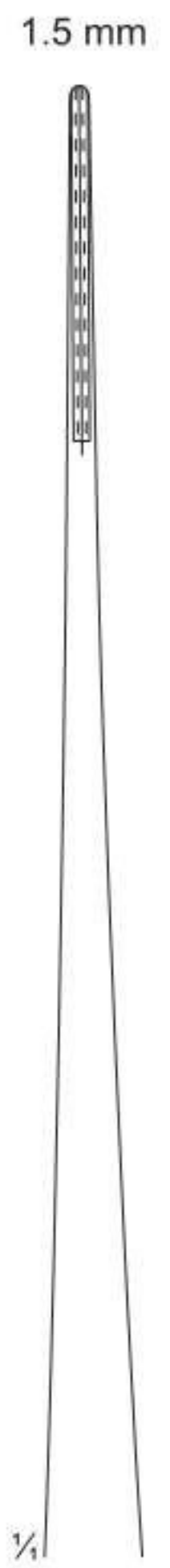

1.5 mm

# Forceps

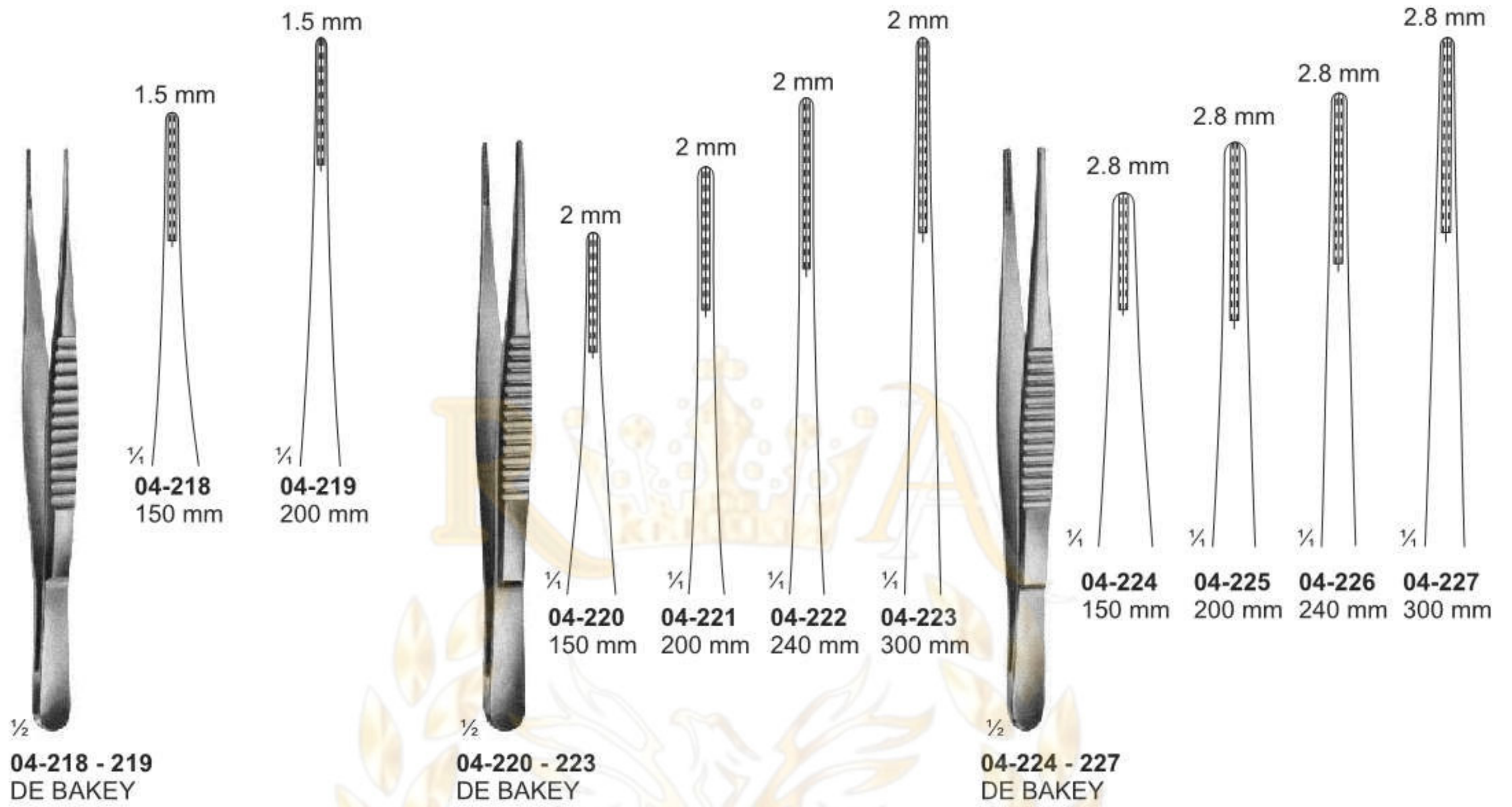

# Forceps, Bayonet - Shaped



**04-233**  
LUCAE  
140 mm

**04-234**  
LUCAE  
1x2 teeth  
140 mm

**04-235**  
COTTLE  
Forceps with  
jaws toothed  
and serrated  
140 mm

**04-236**  
JANSEN  
160 mm

**04-237**  
GRUENWALD  
200 mm

**04-238**  
1x2 teeth  
200 mm

**04-239**  
TROELTSCH  
100 mm

**04-240**  
TROELTSCH  
115 mm

**04-241**  
TROELTSCH  
1X2 teeth  
115 mm

**04-242**  
WILDE  
115 mm

**04-243**  
TROELTSCH  
Cross action  
120 mm

**04-244**  
TROELTSCH  
140 mm

# Delicate Tissue Forceps

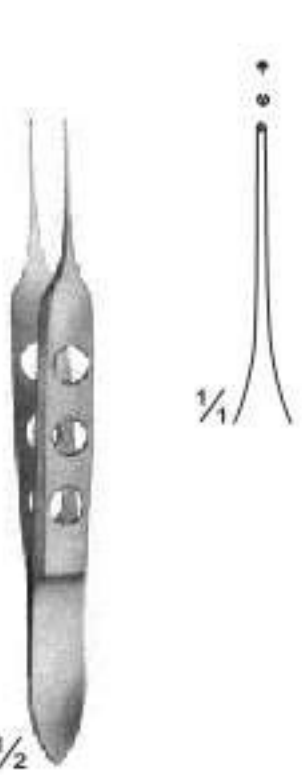

**04-245**  
BISHOP-HARMON  
85 mm

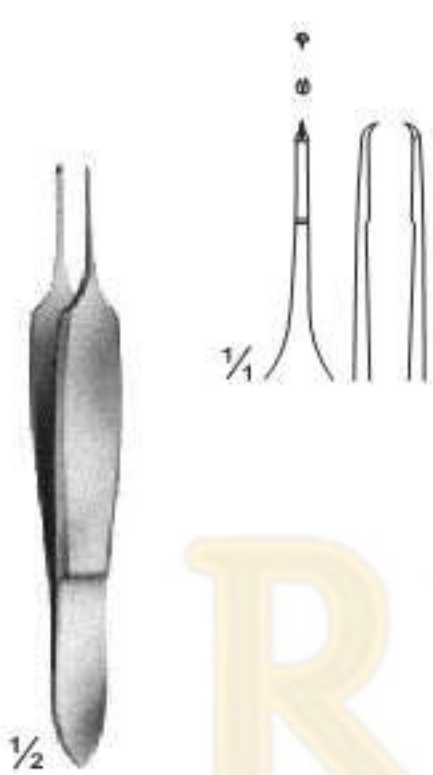

**04-246**  
ST.MARTIN  
80 mm

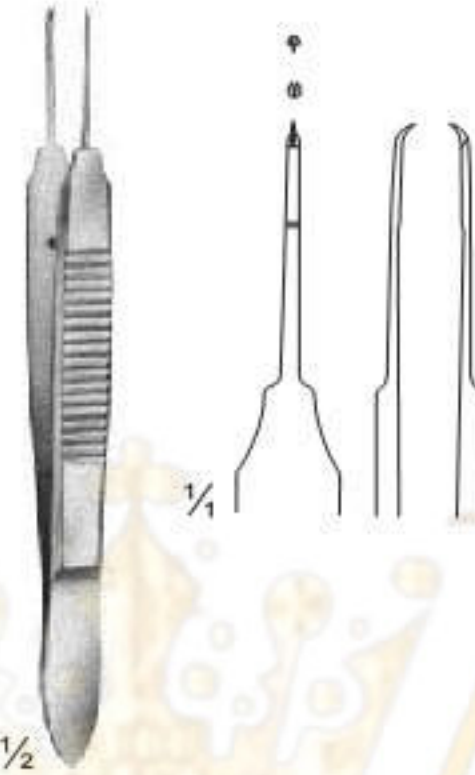

**04-247**  
CASTROVIEJO  
teeth 0.9 mm  
100 mm

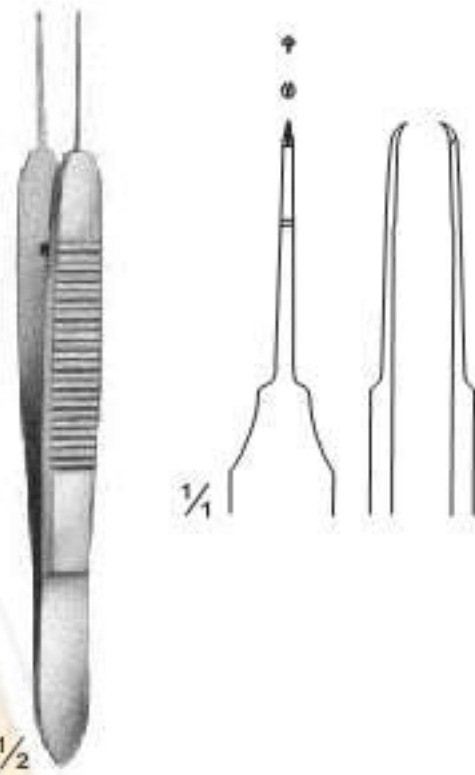

**04-248**  
CASTROVIEJO  
teeth 0.5 mm  
100 mm

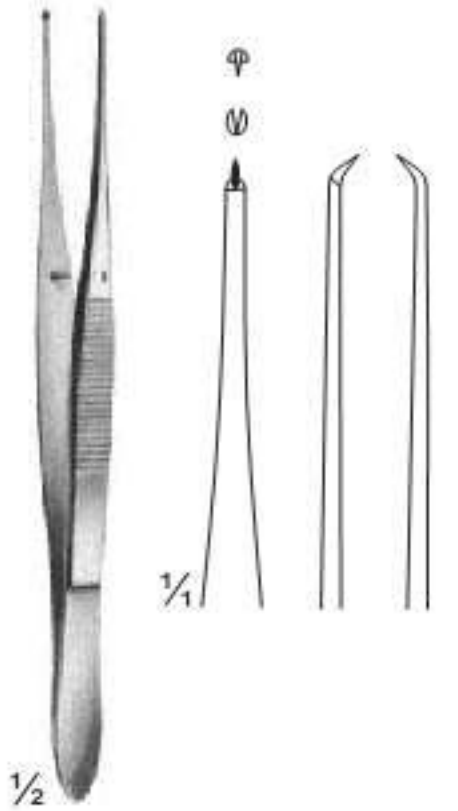

**04-249**  
ELSCHING  
110 mm

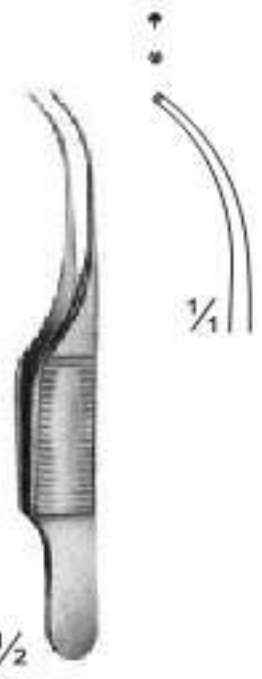

**04-250**  
GILL  
75 mm



**04-251**  
GILL - HESS  
75 mm



**04-252**  
HESS  
70 mm

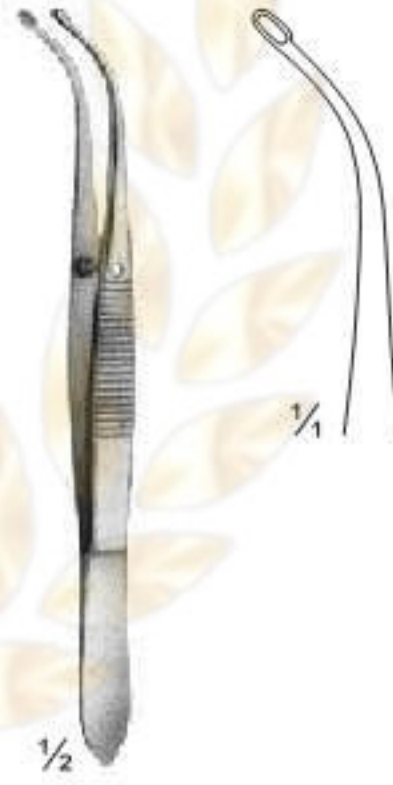

**04-253**  
ARRUGA  
100 mm

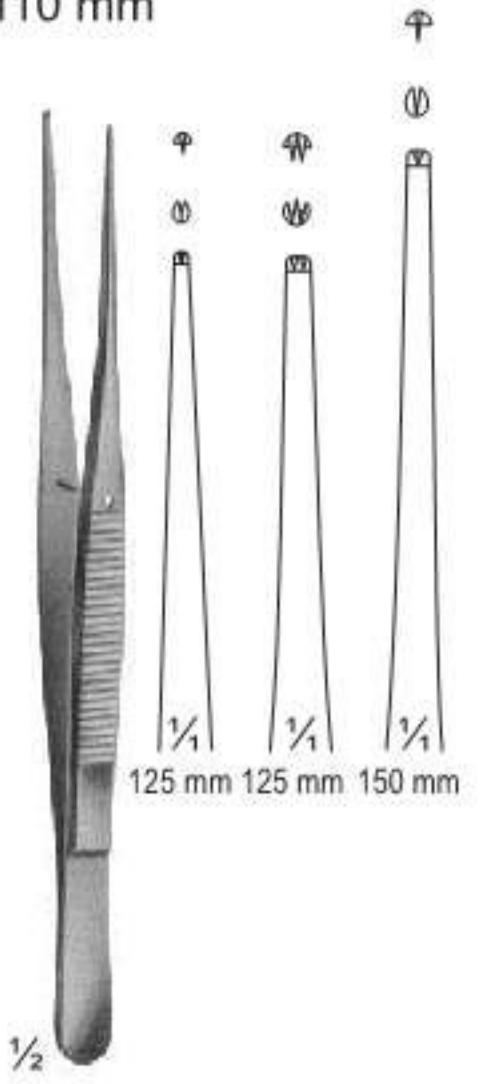

**04-254**  
SEMKEN  
125 mm 125 mm 150 mm

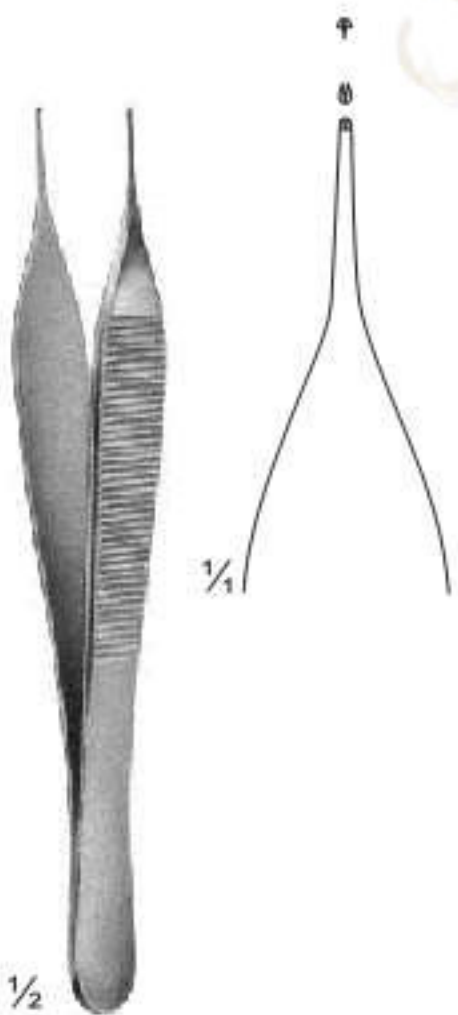

**04-255**  
MICRO-ADSON  
120 mm

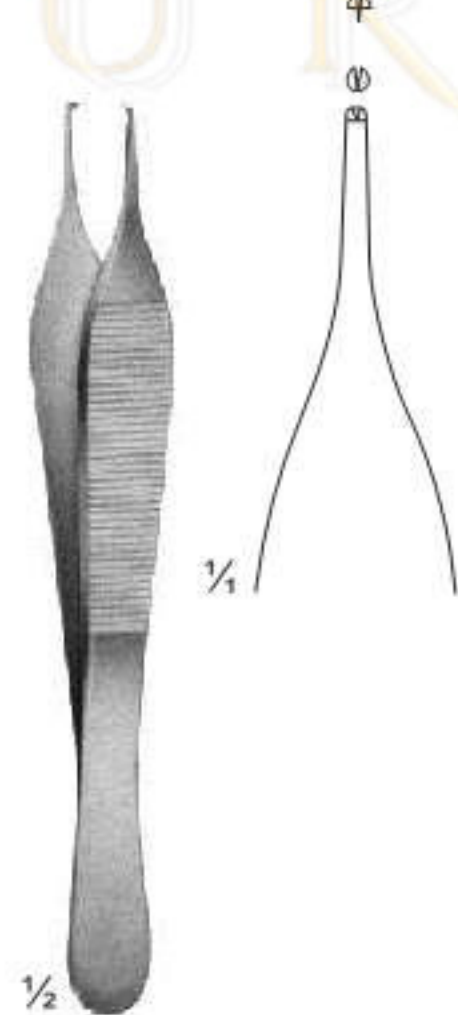

**04-256**  
ADSON  
120 mm

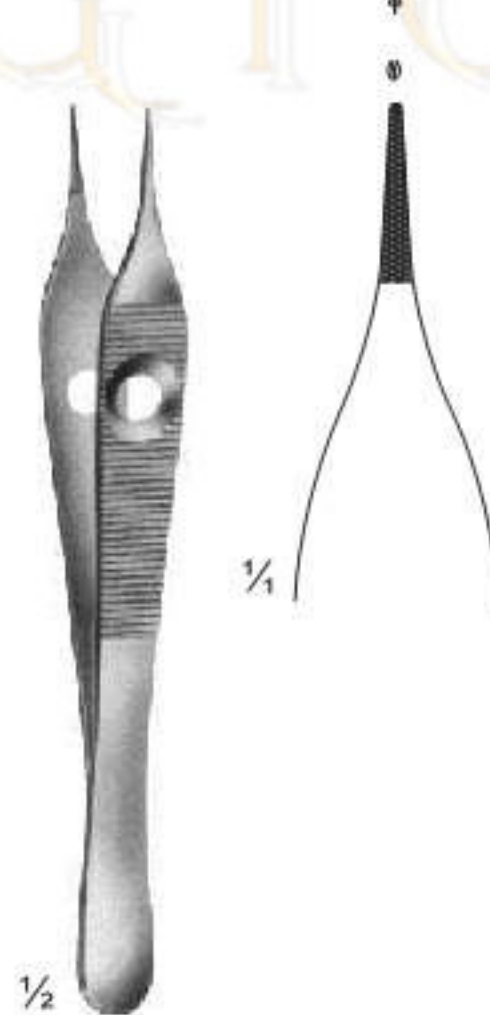

**04-257**  
ADSON  
120 mm



**04-258**  
ADSON  
120 mm

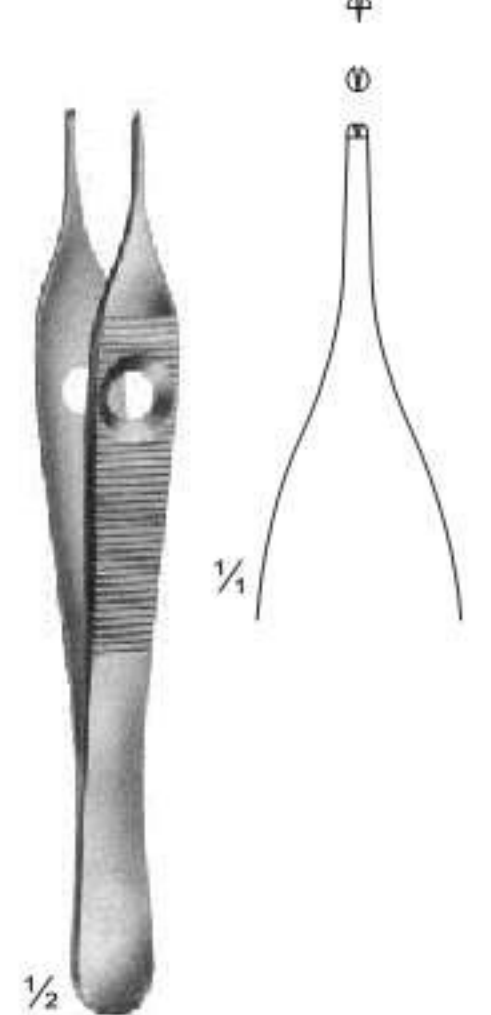

**04-259**  
ADSON  
150 mm

# Tissue Forceps

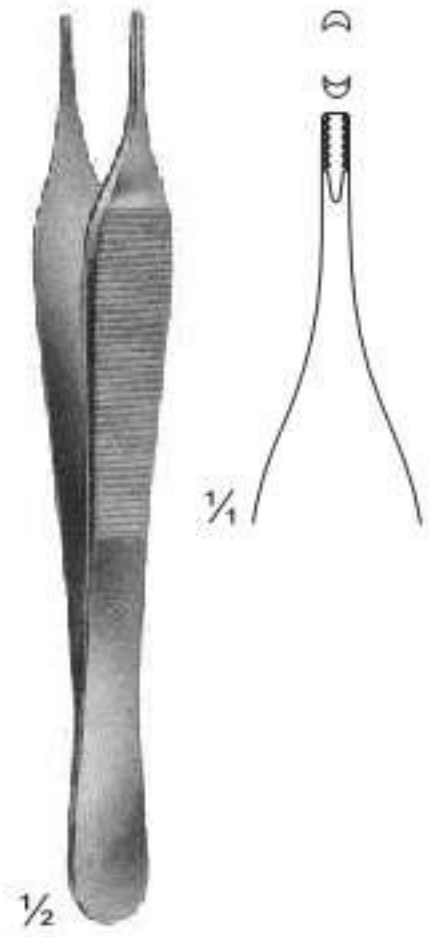

**04-260**  
**ADSON - BROWN**  
Non-traumatic  
120 mm

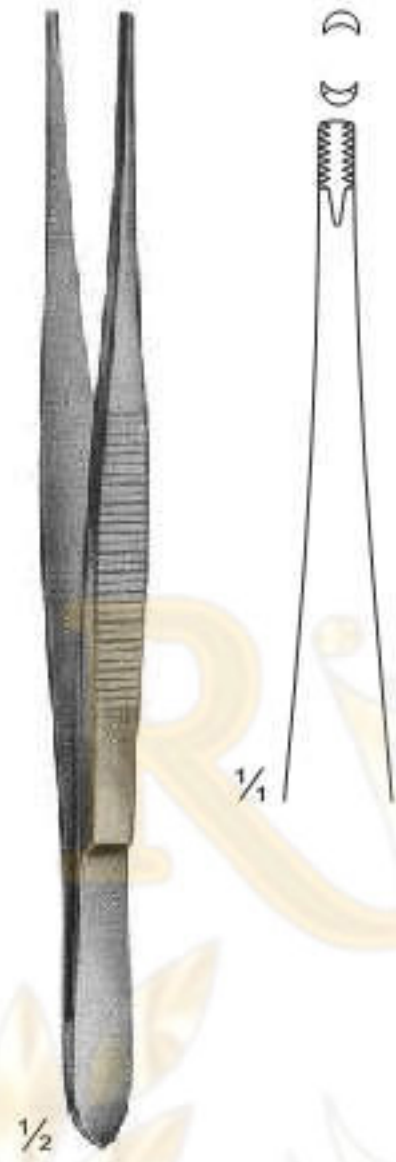

**04-261**  
**BROWN**  
120 mm



**04-262**  
**GRAEFE**  
110 mm

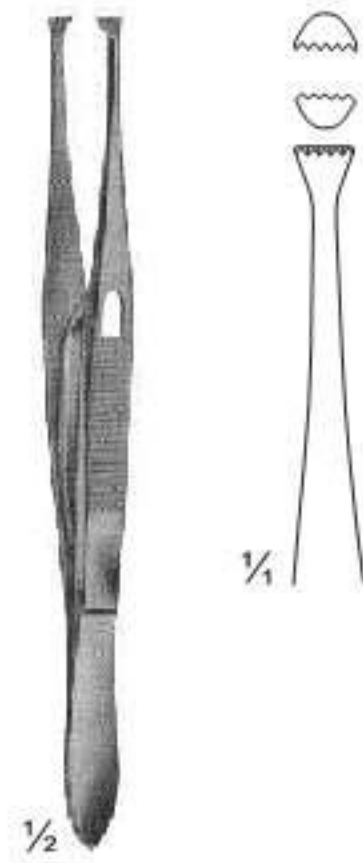

**04-263**  
**GRAEFE**  
With Catch  
110 mm



**04-264 - 272**  
**STANDARD**

- |               |               |               |               |               |               |               |               |               |
|---------------|---------------|---------------|---------------|---------------|---------------|---------------|---------------|---------------|
| <b>04-264</b> | <b>04-265</b> | <b>04-266</b> | <b>04-267</b> | <b>04-268</b> | <b>04-269</b> | <b>04-270</b> | <b>04-271</b> | <b>04-272</b> |
| 105 mm        | 115 mm        | 130 mm        | 145 mm        | 160 mm        | 180 mm        | 200 mm        | 250 mm        | 300 mm        |



**04-273 - 277**  
**GRAEFE**  
110 mm

- |               |               |               |               |               |
|---------------|---------------|---------------|---------------|---------------|
| <b>04-273</b> | <b>04-274</b> | <b>04-275</b> | <b>04-276</b> | <b>04-277</b> |
| 115 mm        | 130 mm        | 145 mm        | 145 mm        | 160 mm        |



# Tissue Forceps

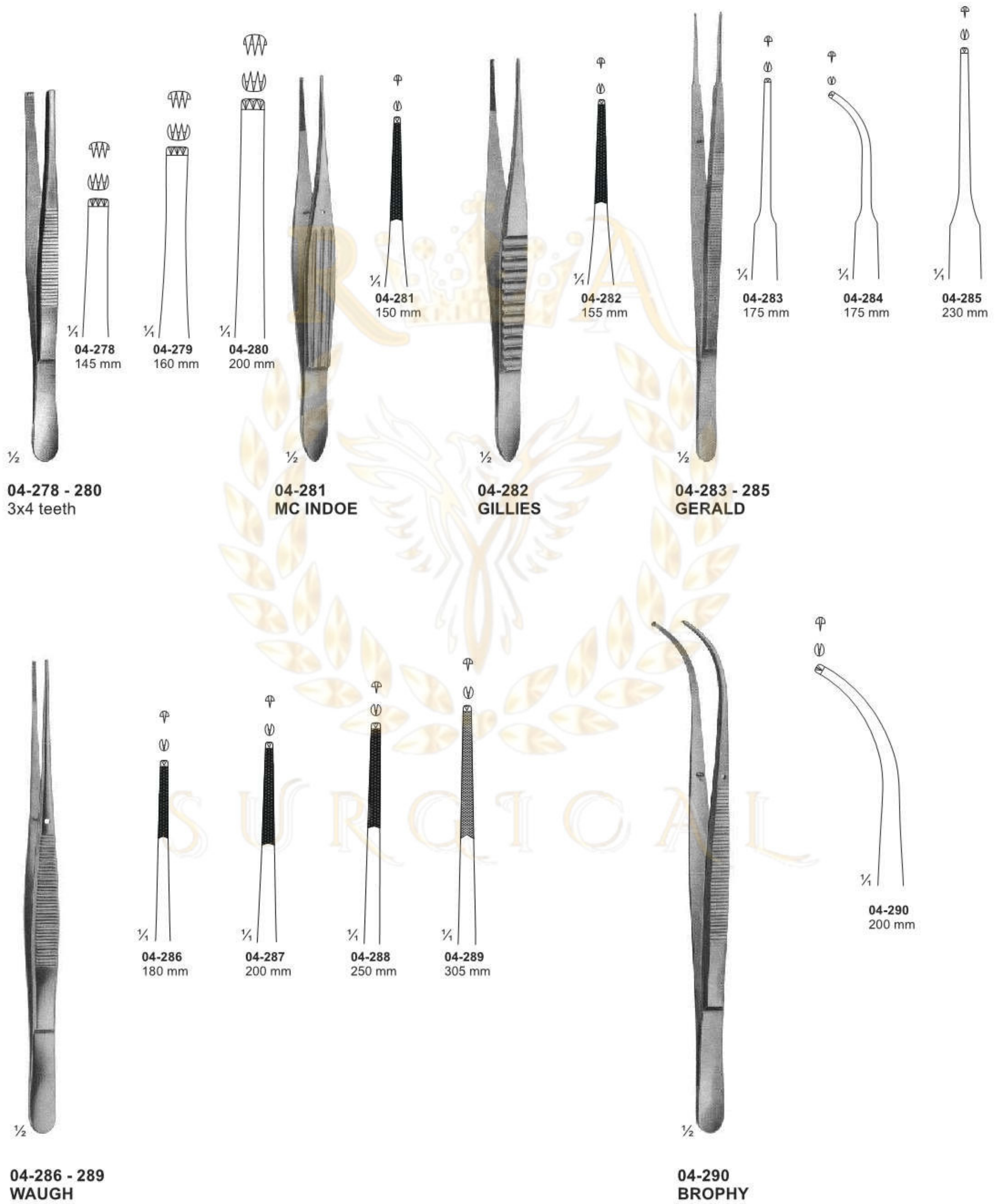

# Tissue Forceps, Lung Dissecting Forceps



**04-291 - 293**  
**LANE**

**04-294 - 295**  
**STRASSBURGER**  
**MODELL**

**04-296**  
**BONNEY**

**04-297**  
**RUSS.MODELL**  
200 mm

**04-298**  
**TUTTLE**  
Lung Dissecting Forceps  
230 mm

**04-299**  
**NELSON**  
Lung Dissecting Forceps  
230 mm

**04-300**  
**DUVAL**  
Intestinal Forceps  
140 mm

**04-301**  
**DENIS-BROWNE**  
Intestinal Forceps  
190 mm

# Splinter and Cilia Forceps

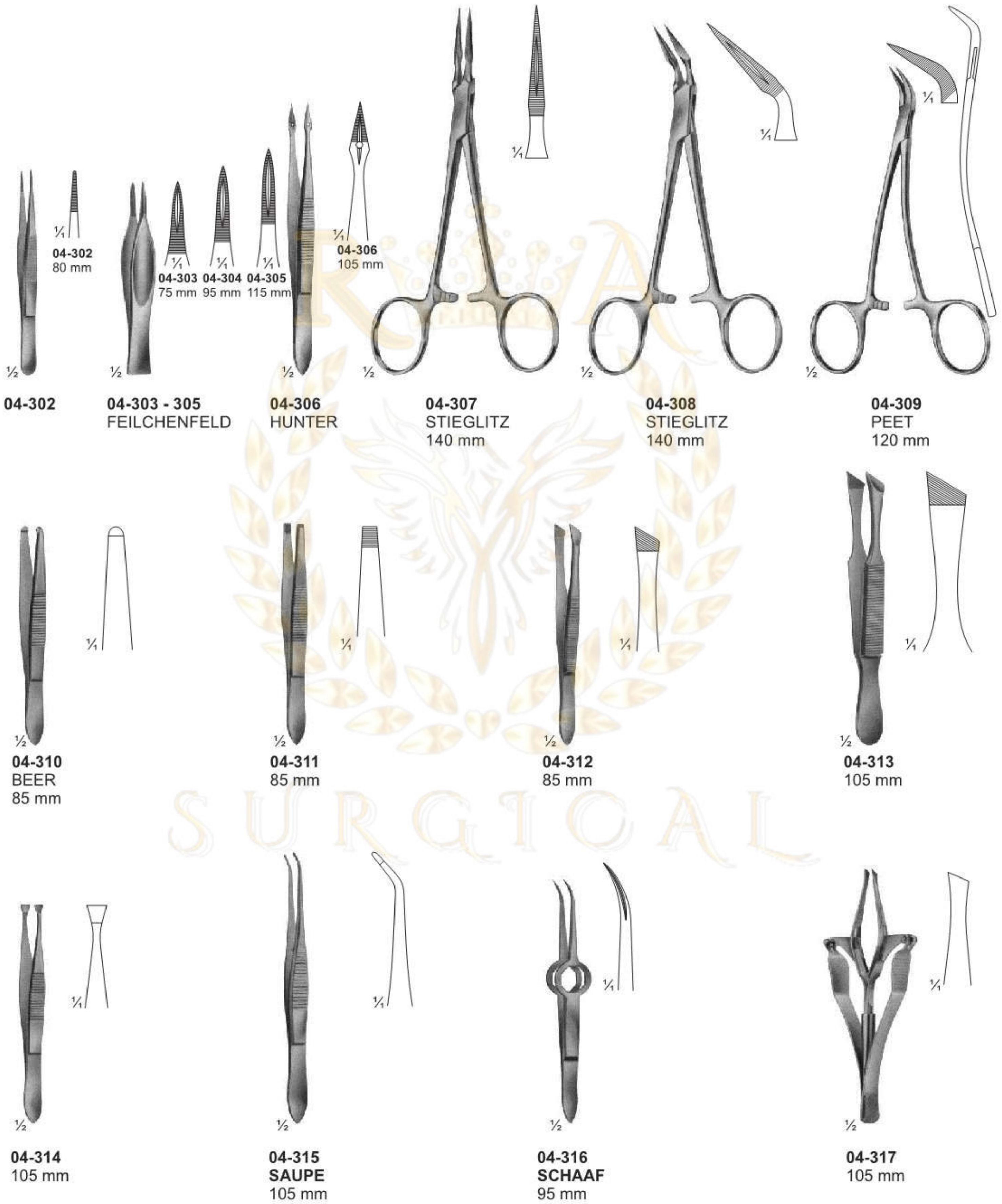

**04-302**  
80 mm

**04-303** 75 mm  
**04-304** 95 mm  
**04-305** 115 mm

**04-306**  
105 mm

**04-307**  
STIEGLITZ  
140 mm

**04-308**  
STIEGLITZ  
140 mm

**04-309**  
PEET  
120 mm

**04-310**  
BEER  
85 mm

**04-311**  
85 mm

**04-312**  
85 mm

**04-313**  
105 mm

**04-314**  
105 mm

**04-315**  
SAUPE  
105 mm

**04-316**  
SCHAAF  
95 mm

**04-317**  
105 mm

# Sponge and Dressing Forceps

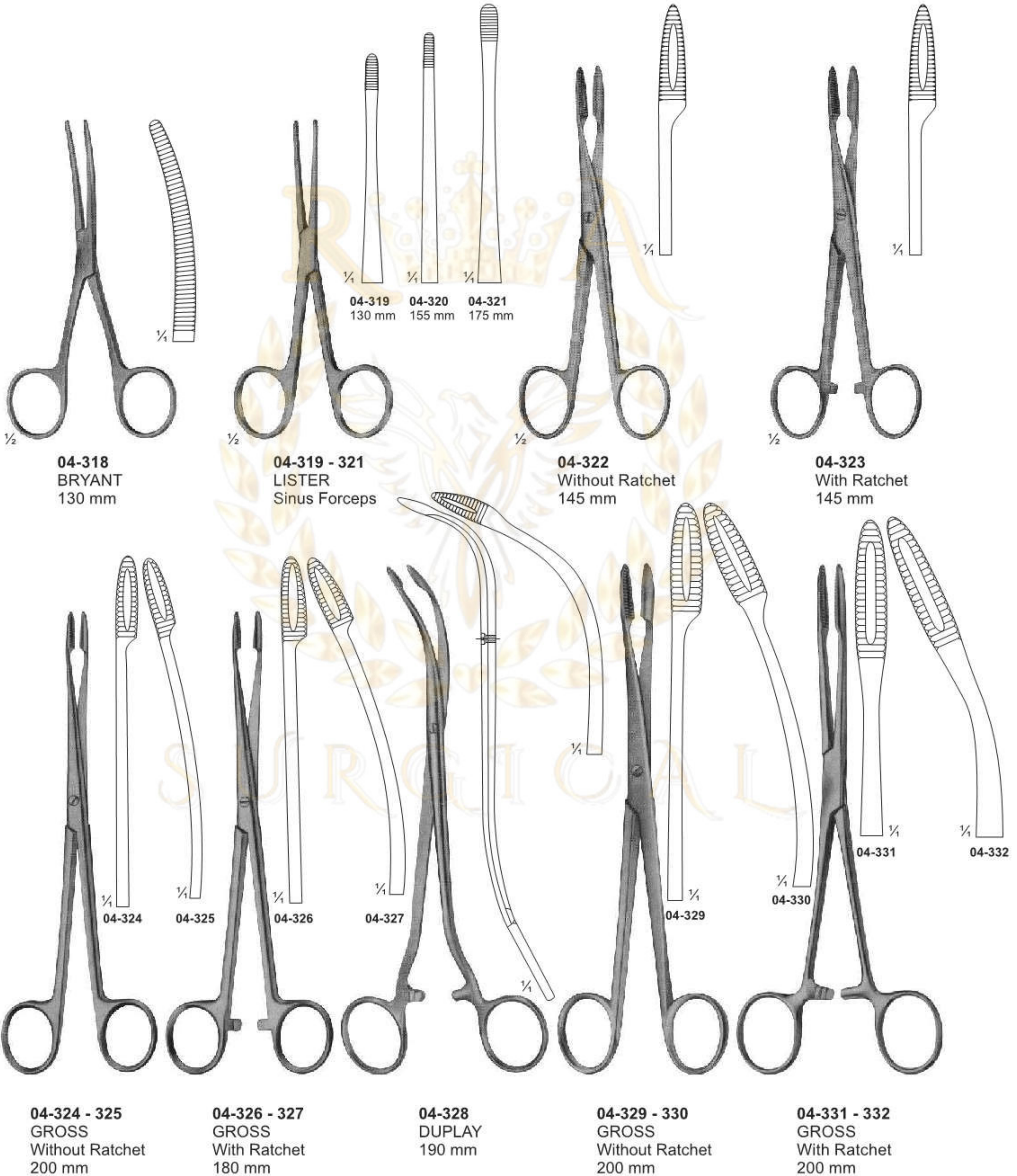

# Sponge and Dressing Forceps



**04-333 - 334**  
AESCULAP  
220 mm

**04-335 - 336**  
MAIER  
Without Ratchet  
265 mm

**04-337 - 338**  
MAIER  
With Ratchet  
265 mm

# Sponge and Dressing Forceps

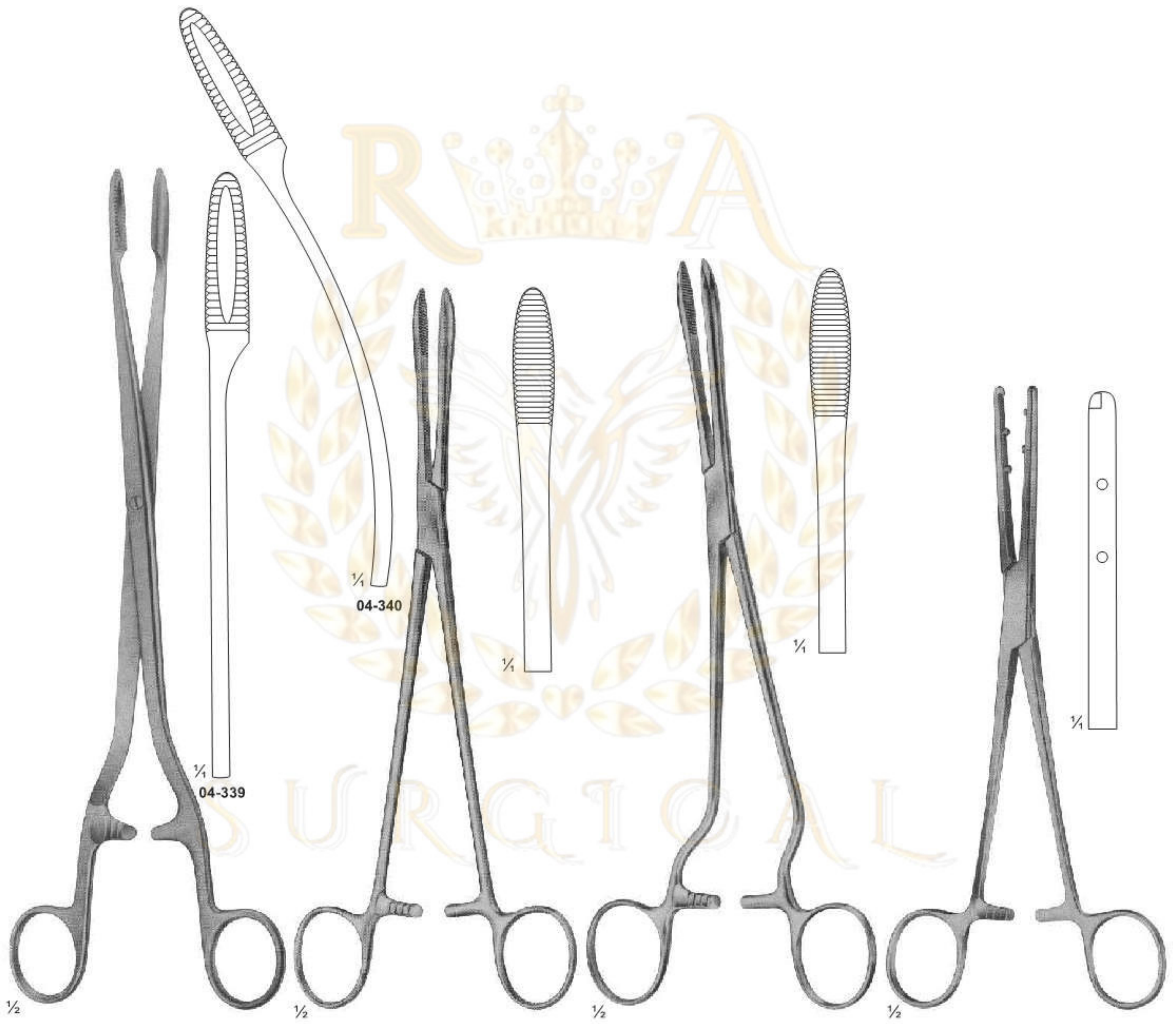

**04-339 - 340**  
SIMS-MAIER  
280 mm

**04-341**  
COLLIN  
240 mm

**04-342**  
CHERON  
Handles Laterally Angled  
240 mm

**04-343**  
EMMET  
210 mm

# Dressing, Sponge holding, Organ and Tissue Grasping Forceps

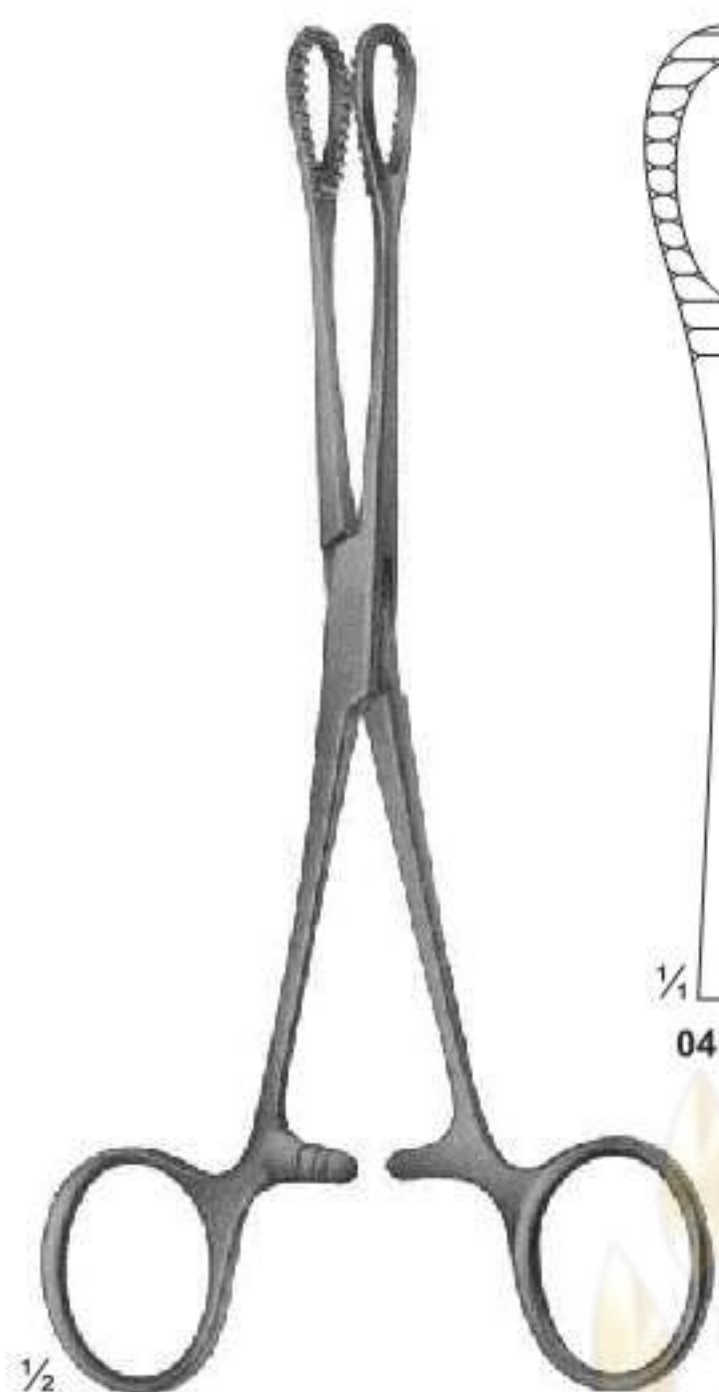

**04-344 - 345**  
FOERSTER-BALLENGER  
180 mm

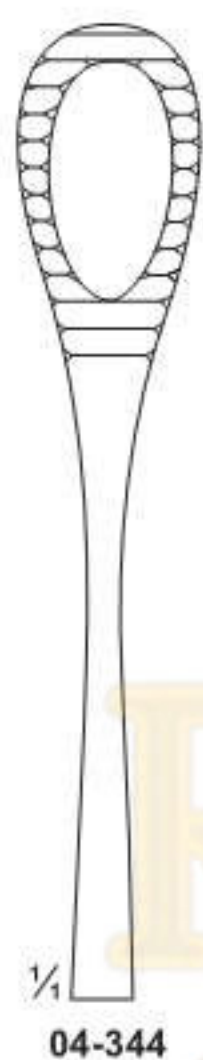

**04-344**



**04-345**



**04-346 - 347**  
RAMPLEY



**04-346**  
180 mm



**04-347**  
250 mm



**04-348 - 351**  
FOERSTER-BALLENGER  
240 mm



**04-348**  
Smooth Jaws



**04-349**  
Smooth Jaws



**04-350**  
Serrated Jaws



**04-351**  
Serrated Jaws

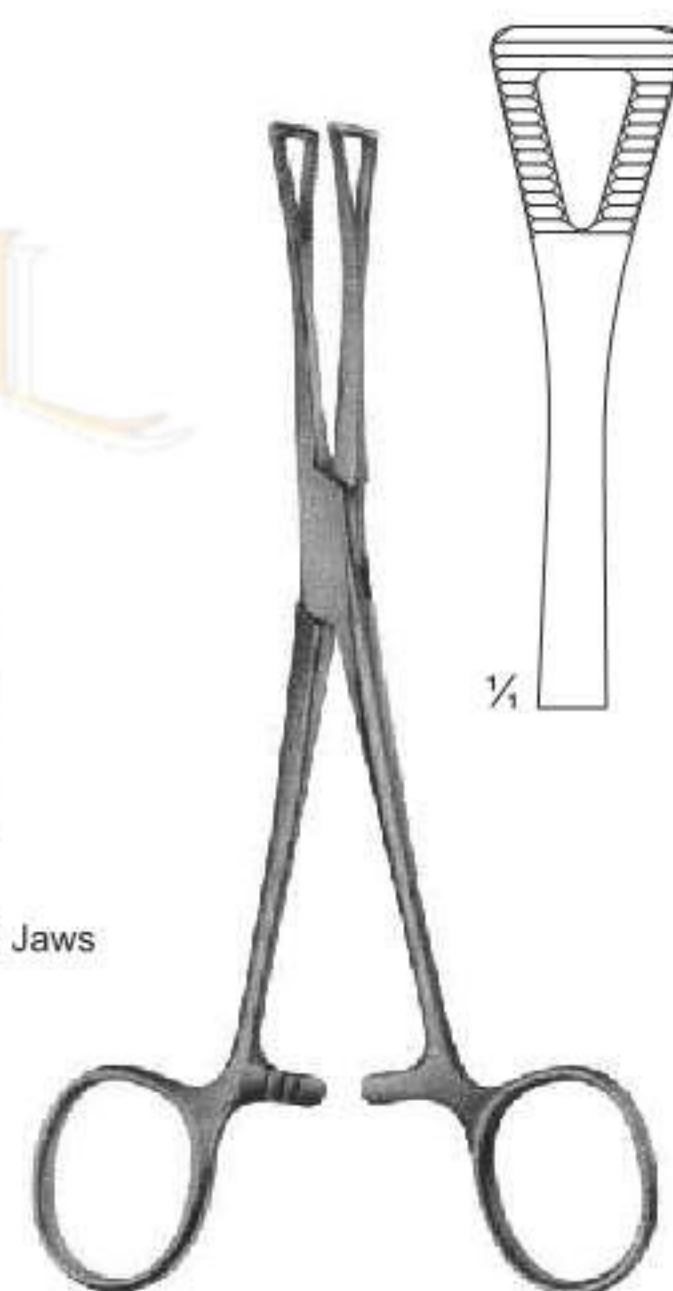

**04-352**  
PENNINGTON  
155 mm



**1/4**

# Dressing, Sponge holding, Organ and Tissue Grasping Forceps

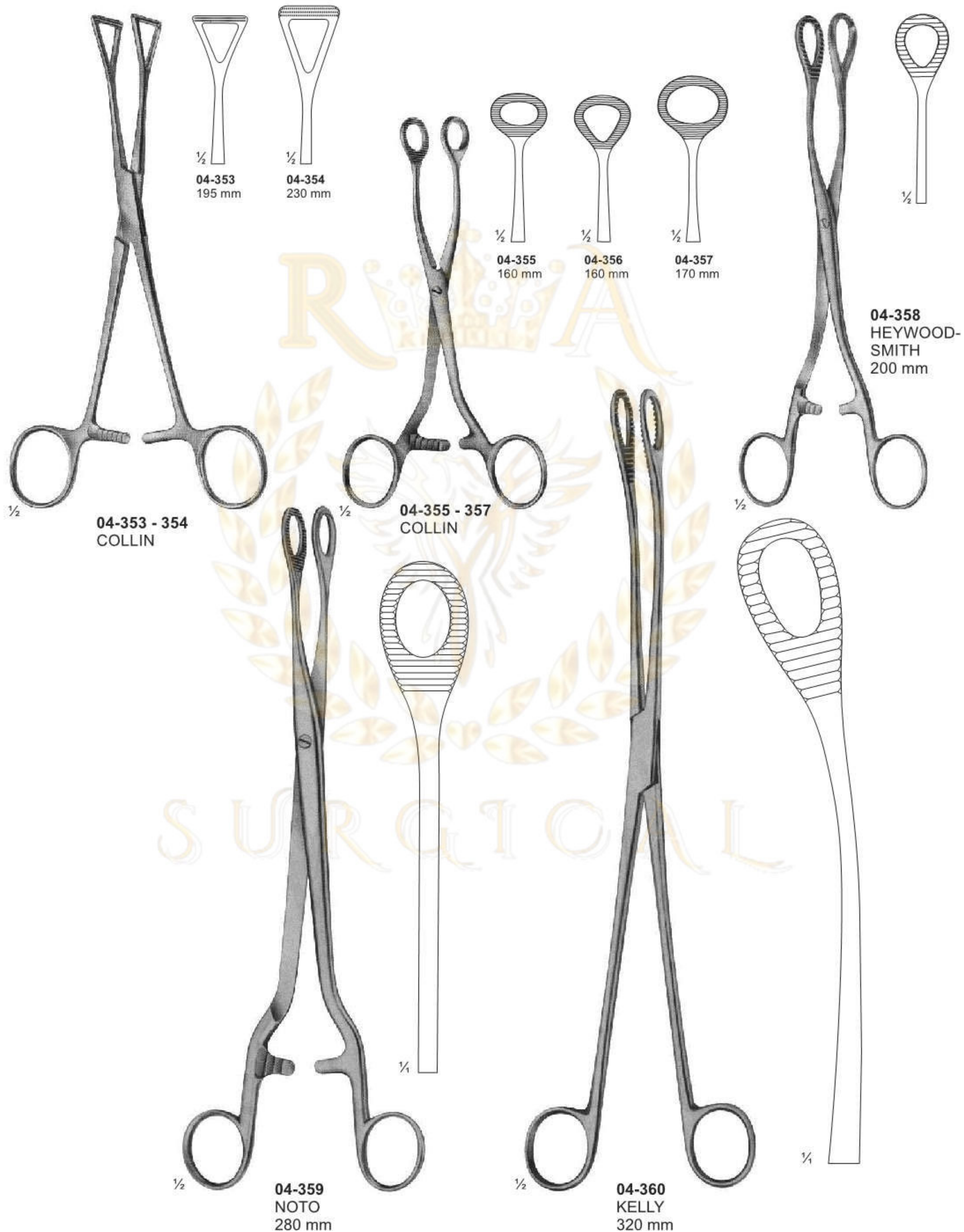



# Tendon Seizing Forceps

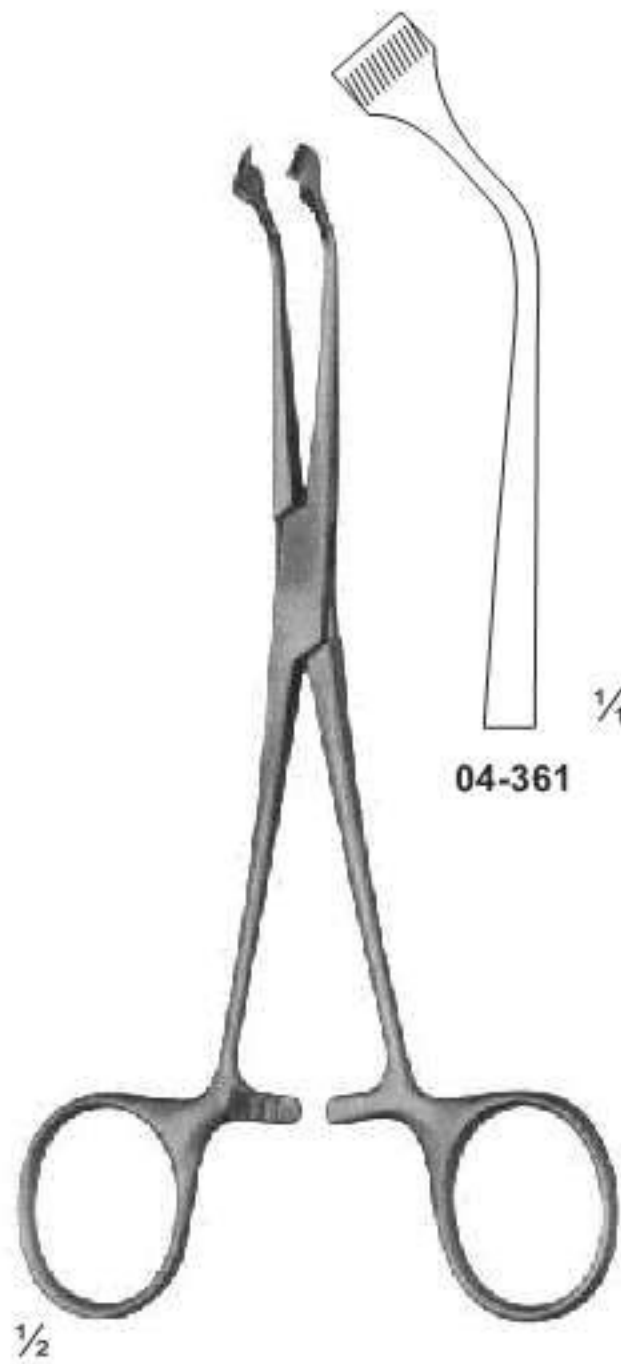

04-361

04-362

**04-361 - 362**  
HERZ  
155 mm



04-363

**04-363**  
JACKSON  
4 x 5 teeth  
150 mm



**04-364**  
150 mm



**04-365**  
150 mm



**04-366**  
120 mm

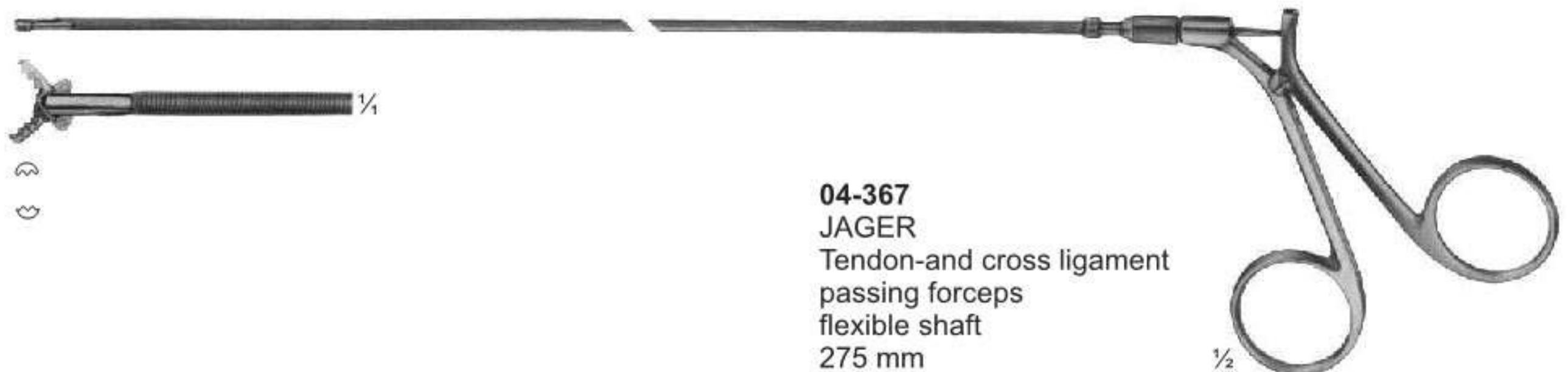

**04-367**  
JAGER  
Tendon-and cross ligament  
passing forceps  
flexible shaft  
275 mm

# Artery Traction - and Tissue Grasping Forceps

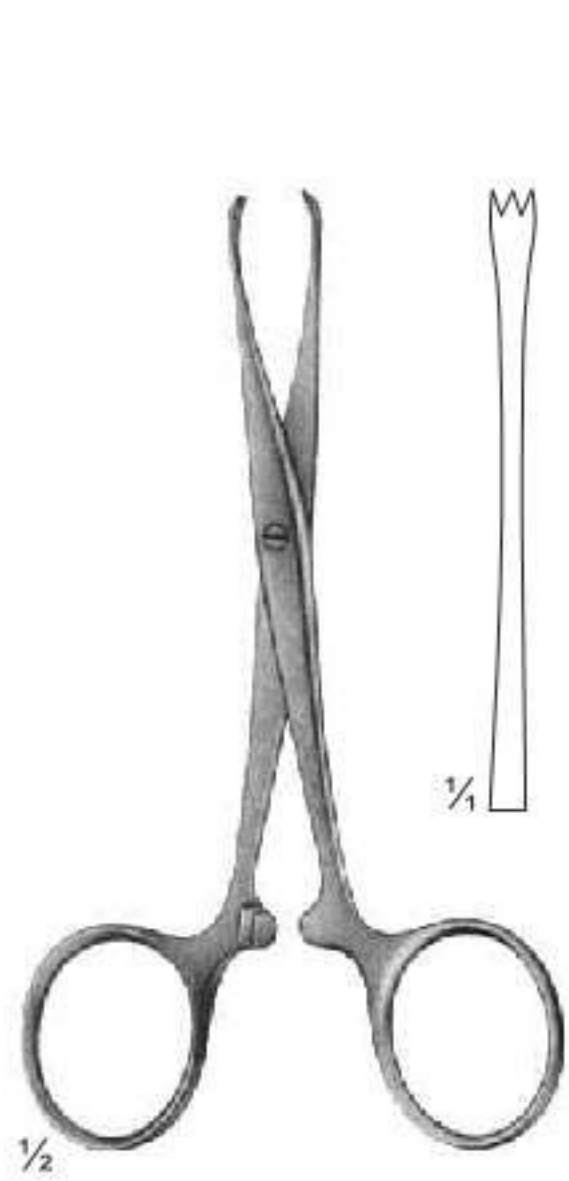

**04-368**  
**CHAPUT**  
 2 x 3 teeth  
 125 mm

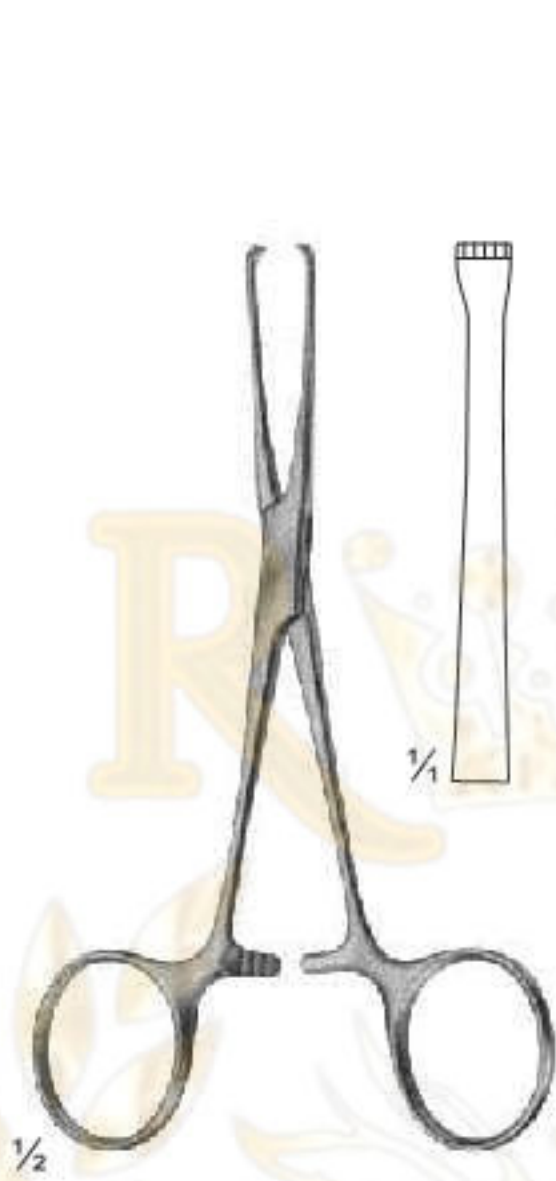

**04-369**  
**BABY-ALLIS**  
 4 x 5 teeth  
 130 mm

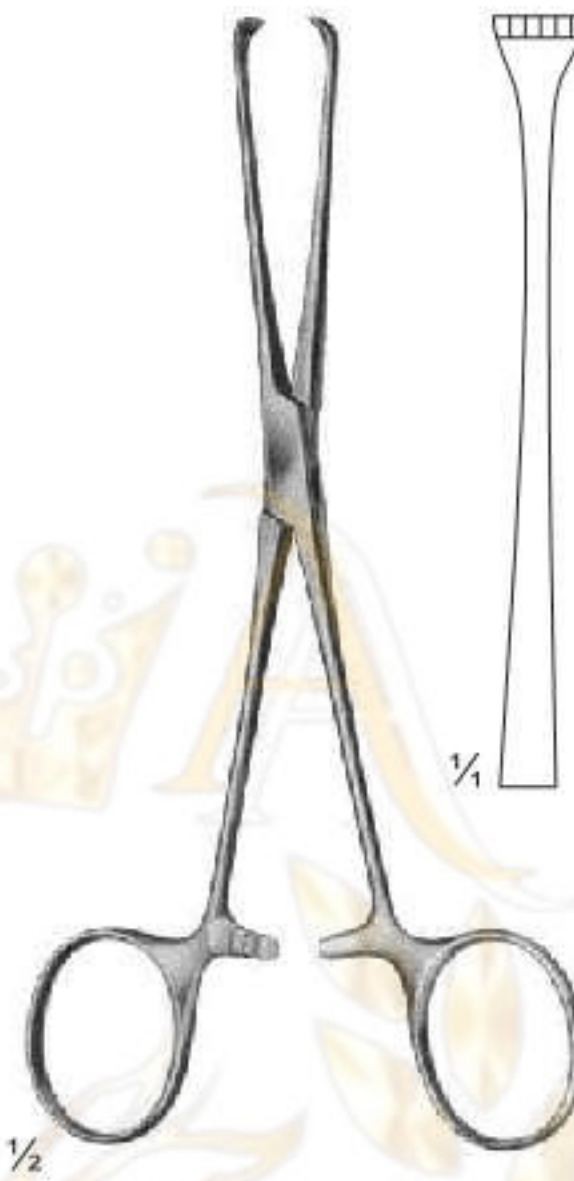

**04-370**  
**BOYS-ALLIS**  
 5 x 6 teeth  
 155 mm

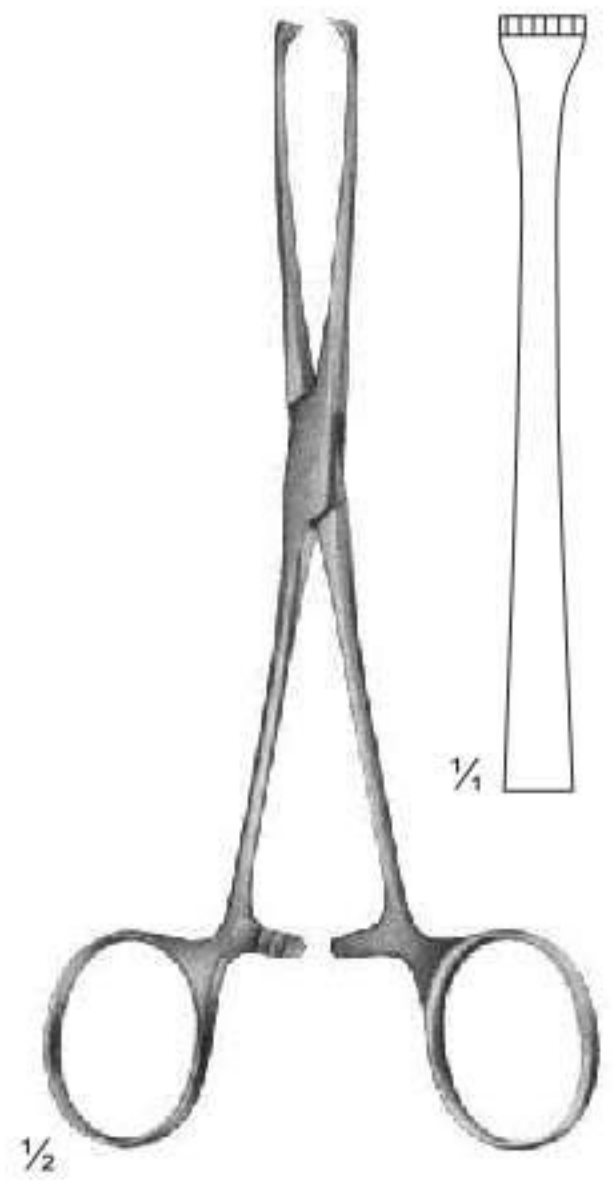

**04-371**  
**ALLIS**  
 5 x 6 teeth  
 155 mm

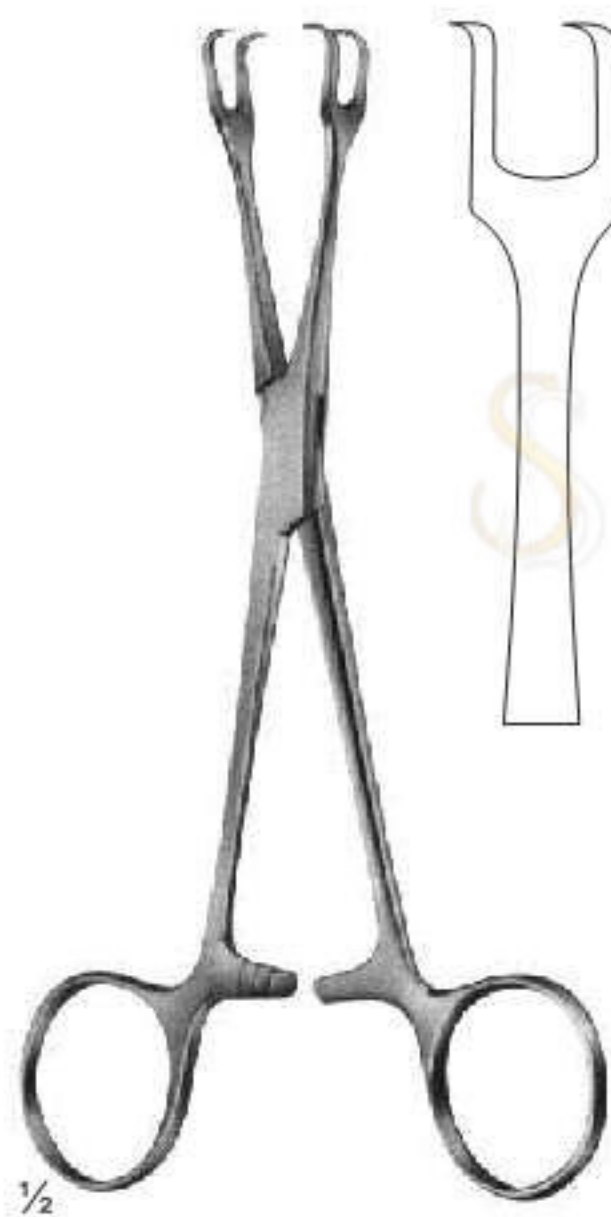

**04-372**  
**LAHEY**  
 135 mm

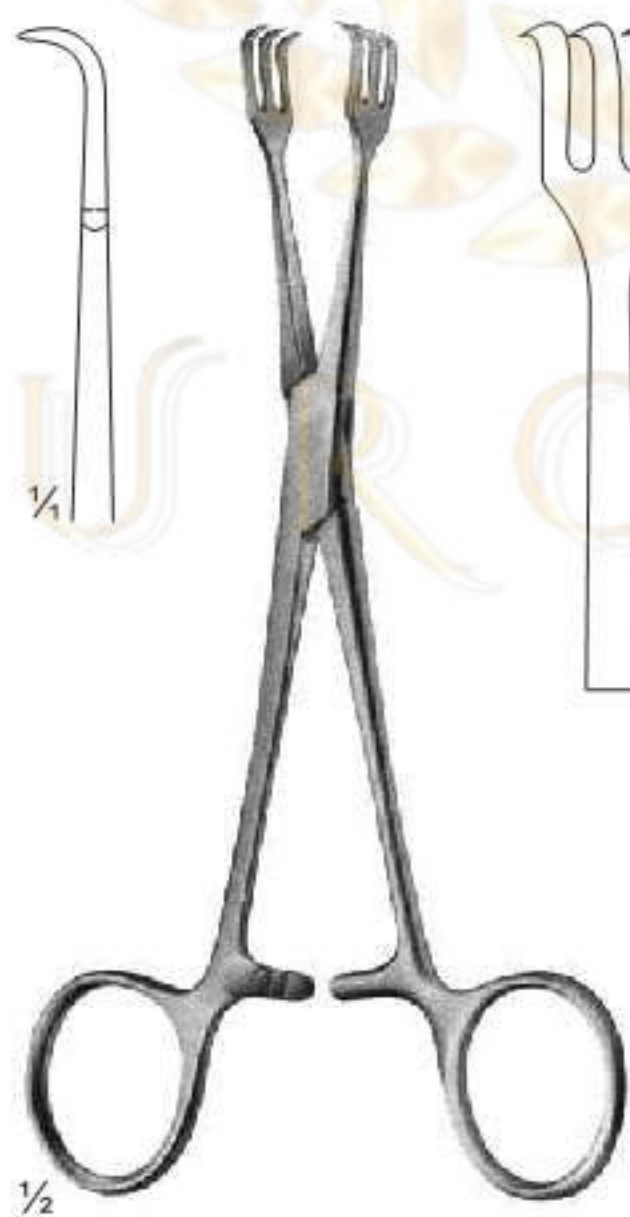

**04-373**  
**LAHEY**  
 135 mm

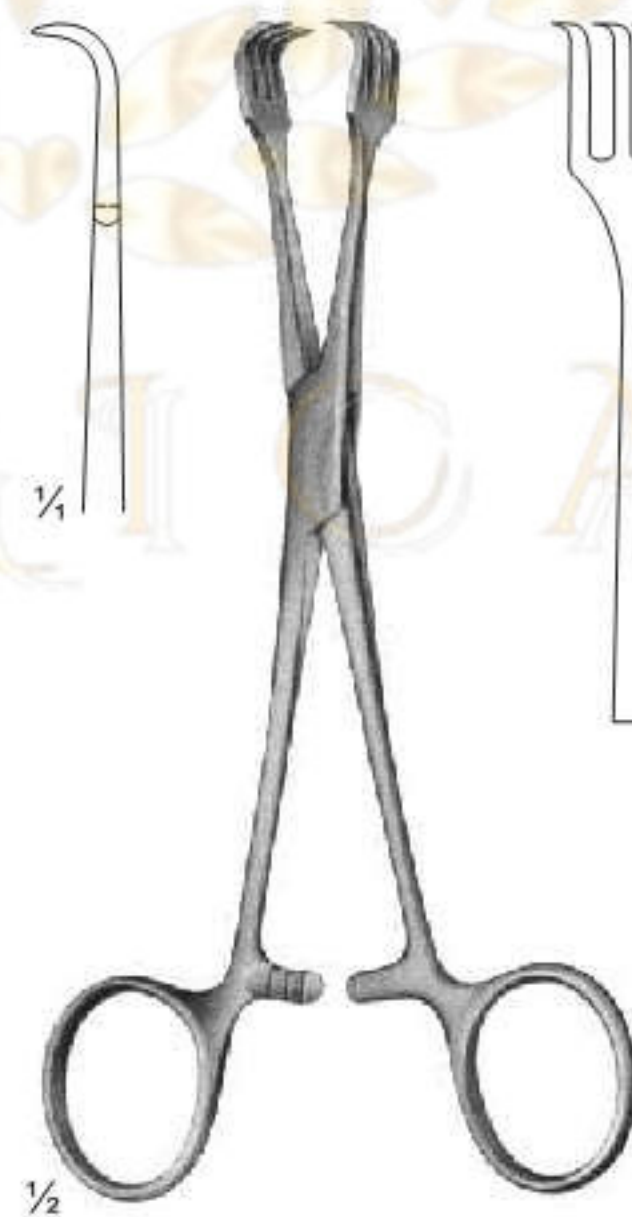

**04-374**  
**BRAUN**  
 155 mm

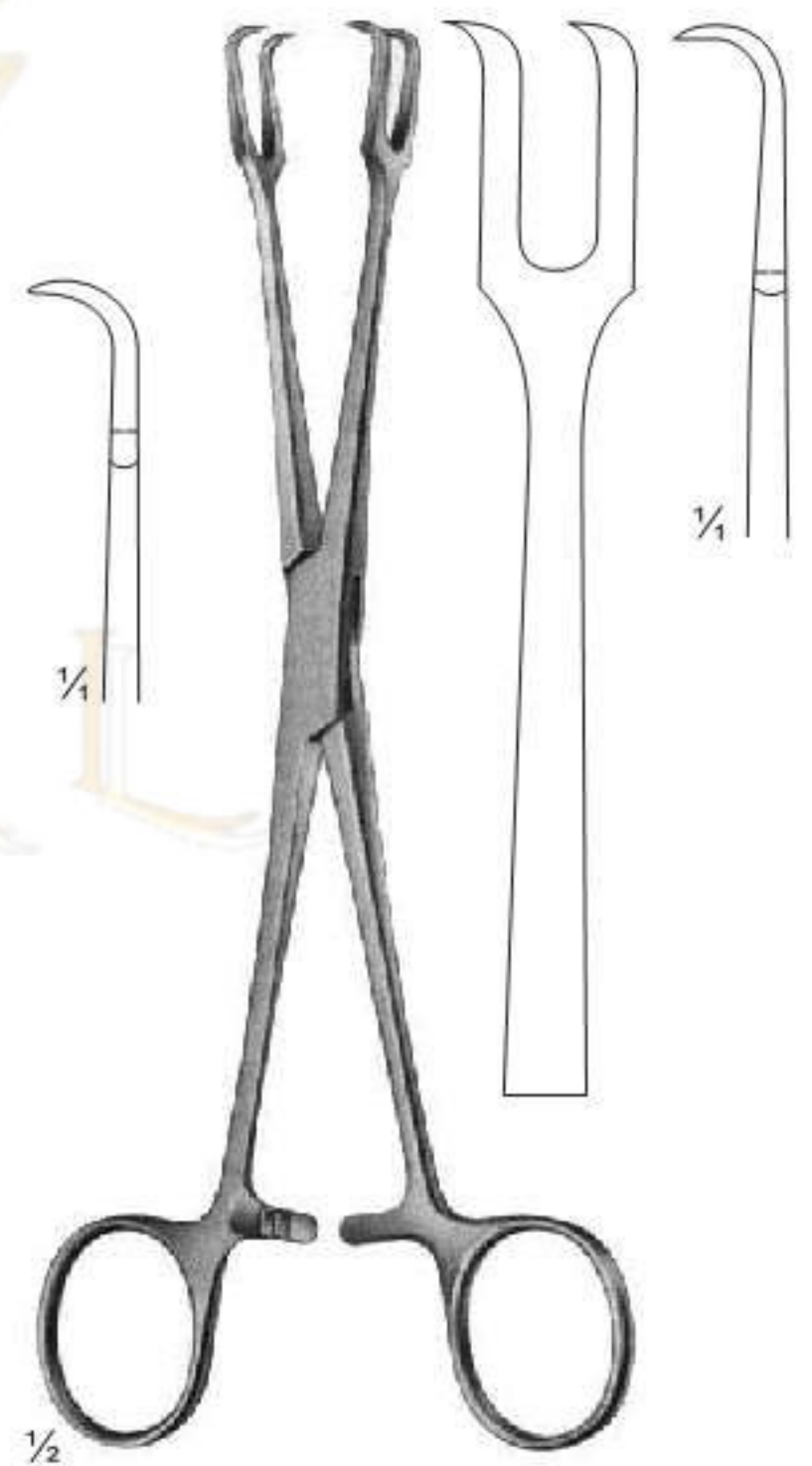

**04-375**  
**MUSEUX**  
 200 mm

# Organ - and Tissue Grasping Forceps

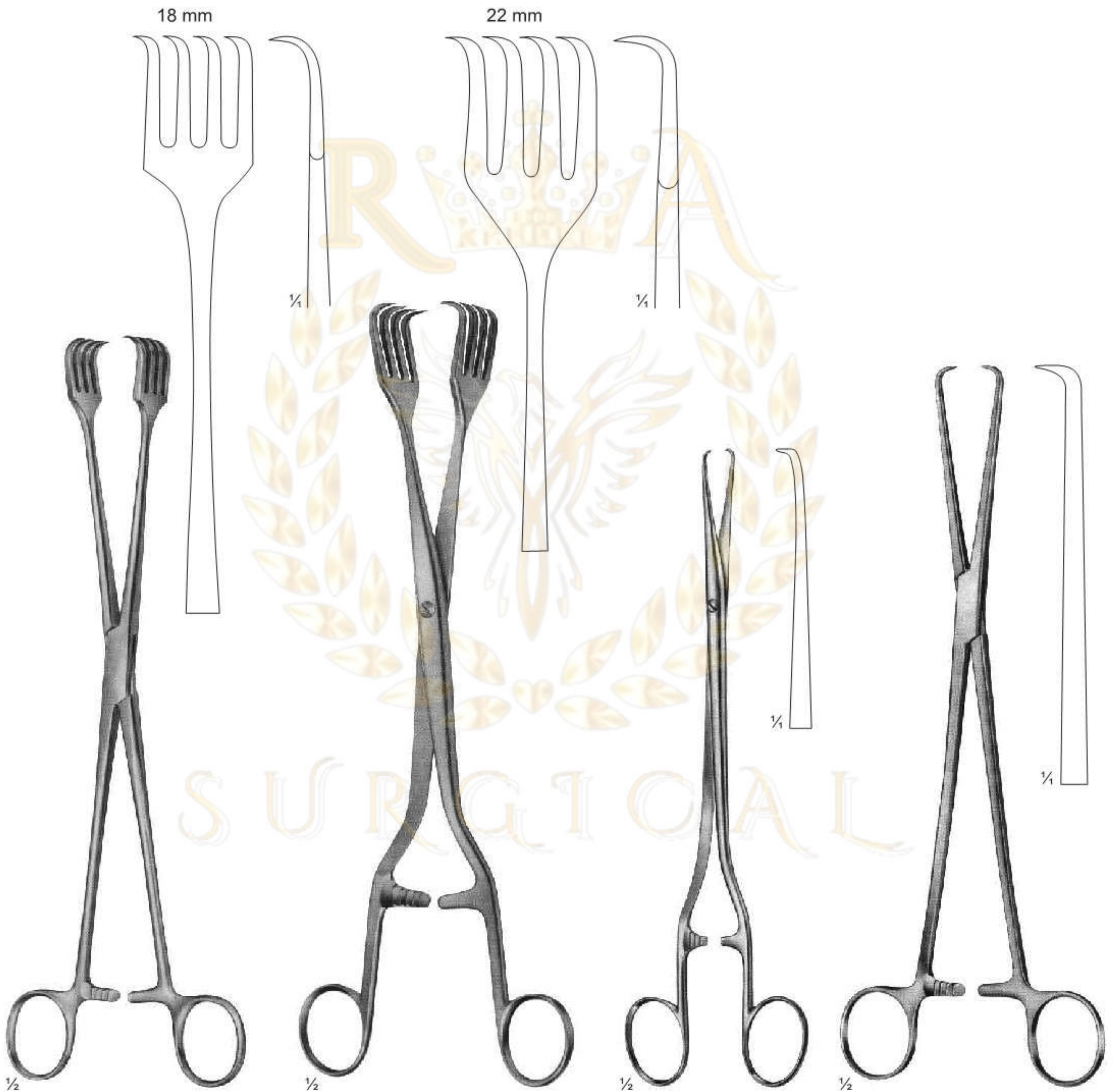

**04-376**  
AESCULAP  
260 mm

**04-377**  
PRATT  
270 mm

**04-378**  
TIEMANN  
Bullet forceps  
220 mm

**04-379**  
SCHRODER  
250 mm

# Towel Clamps



**05-101**  
JONES  
85 mm

**05-102**  
ENGL. MOD.  
85 mm

**05-103 - 104**  
SCHAEDEL  
85 mm

**05-105**  
DOYEN  
110 mm

**05-106**  
DOYEN  
180 mm



**05-107**  
130 mm

**05-108**  
155 mm

**05-109**  
195 mm

**05-110**  
80 mm

**05-111**  
105 mm

**05-112 05-113 05-114**  
90 mm 110 mm 135 mm

**05-115**  
BACKHAUS-KOCHER  
135 mm

**05-116**  
ROEDER  
135 mm

**05-107 - 109**  
LANE

**05-110 - 111**  
BACKHAUS

**05-112 - 114**  
BACKHAUS

# Towel Clamps

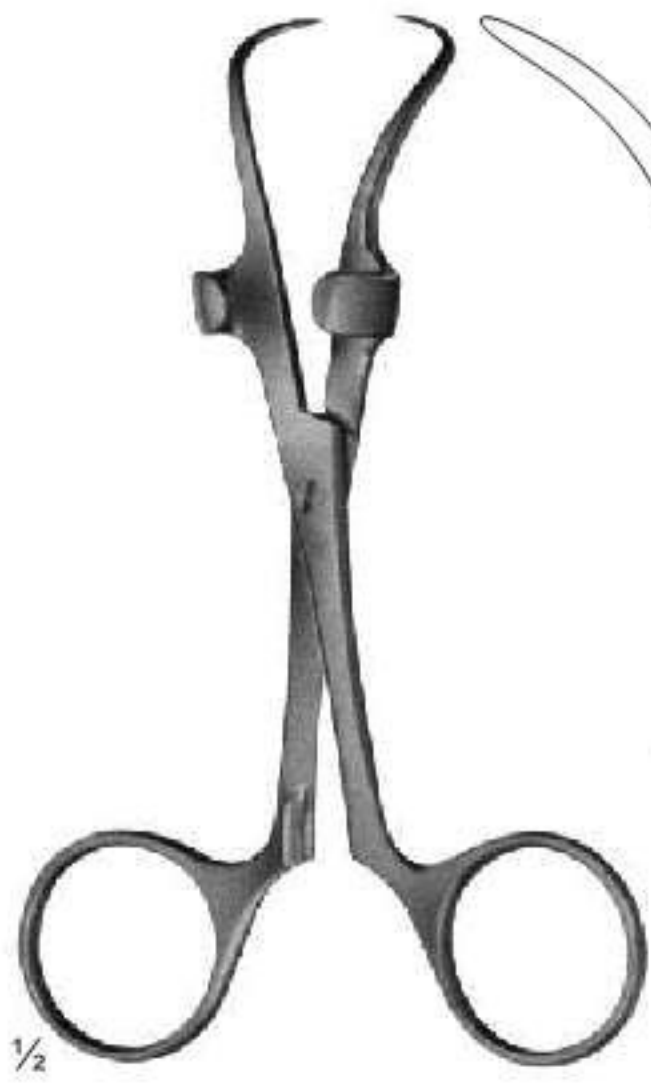

**05-117**  
ROBIN  
with holders for tubing  
up to 13 mm  
135 mm



**05-118**  
with clip for tubing  
up to 15 mm  
110 mm



**05-119**  
LORNA  
non perforating  
130 mm



**05-120**  
for paper cloths  
140 mm



**05-121**  
BUNT  
105 mm

















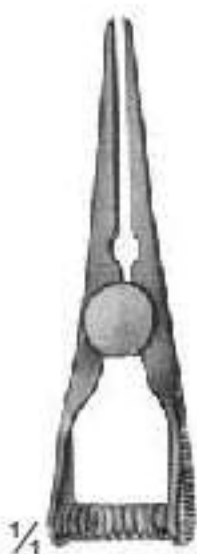
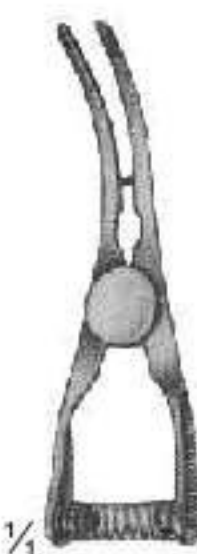









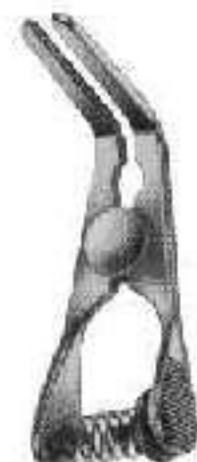

**05-122**  
MAYO  
140 mm

# Muller Vessel Clips and Bulldog Clamps



## Closing force

											
<b>05-123</b> Straight	<b>05-124</b> Curved	<b>05-125</b> Curved tips	<b>05-126</b> Angled Shaped	<b>05-127</b> Muller Knee-bent	<b>05-128</b> Muller Ligation Forceps	Jaw, cross serrated					
80g 50g	80g 50g	80g 50g	80g 50g	80g 50g	80g 50g						
											
<b>05-129</b> 35 mm	<b>05-130</b> 35 mm	<b>05-131</b> 45 mm	<b>05-132</b> 45 mm	<b>05-133</b> <b>05-134</b> 38 mm 48 mm	<b>05-135</b> <b>05-136</b> 38 mm 48 mm	<b>05-137</b> 58 mm	<b>05-138</b> 58 mm	<b>05-139 - 145</b> 91 mm	<b>05-146</b> DE BAKEY- HESS 20 mm	<b>05-139</b> 38 mm <b>05-140</b> 48 mm <b>05-141</b> 56 mm <b>05-142</b> 63 mm <b>05-143</b> 70 mm <b>05-144</b> 80 mm <b>05-145</b> 90 mm	
											
<b>05-147</b> Length 50 mm Jaws 27 mm	<b>05-148</b> Length 48 mm Jaws 27 mm	<b>05-149</b> GLOVER Length 57 mm Jaws 35 mm	<b>05-150</b> DE BAKEY Length 73 mm Jaws 38 mm	<b>05-151</b> DE BAKEY Length 99 mm Jaws 63 mm	<b>05-152</b> DE BAKEY Length 95 mm Jaws 54 mm	<b>05-153</b> L. 80 mm	<b>05-154</b> L. 90 mm	<b>05-157</b> L. 78 mm	<b>05-161</b> GLOVER L. 68 mm	<b>05-164</b> GLOVER L. 65 mm	
						<b>05-155</b> L. 105 mm	<b>05-156</b> L. 124 mm	<b>05-158</b> L. 86 mm	<b>05-162</b> L. 96 mm	<b>05-165</b> L. 91 mm	
						<b>05-159</b> L. 97 mm	<b>05-160</b> L. 114 mm	<b>05-163</b> L. 117 mm	<b>05-166</b> L. 110 mm		

# Delicate Haemostatic Forceps



# Delicate Haemostatic Forceps

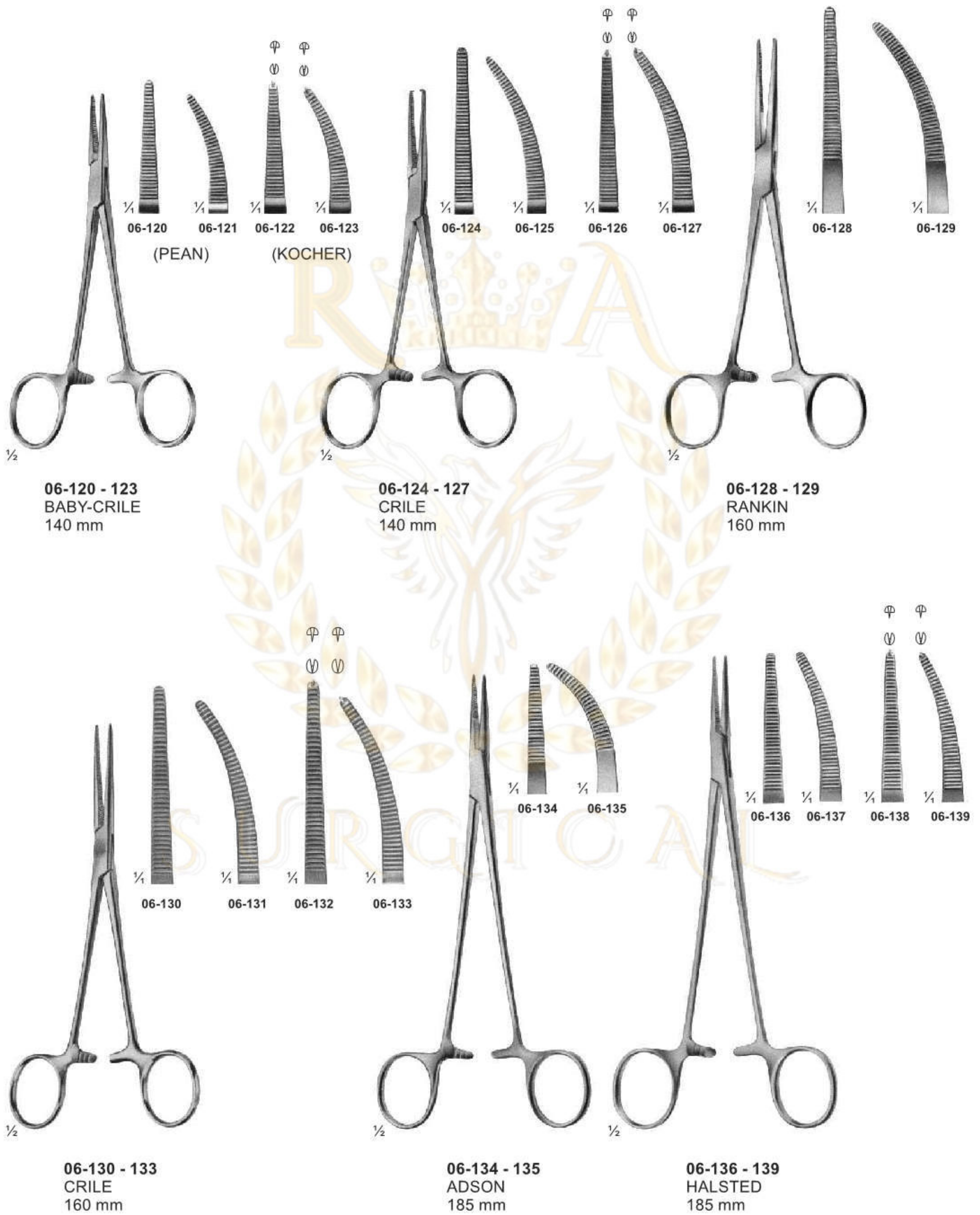



# Delicate Haemostatic Forceps

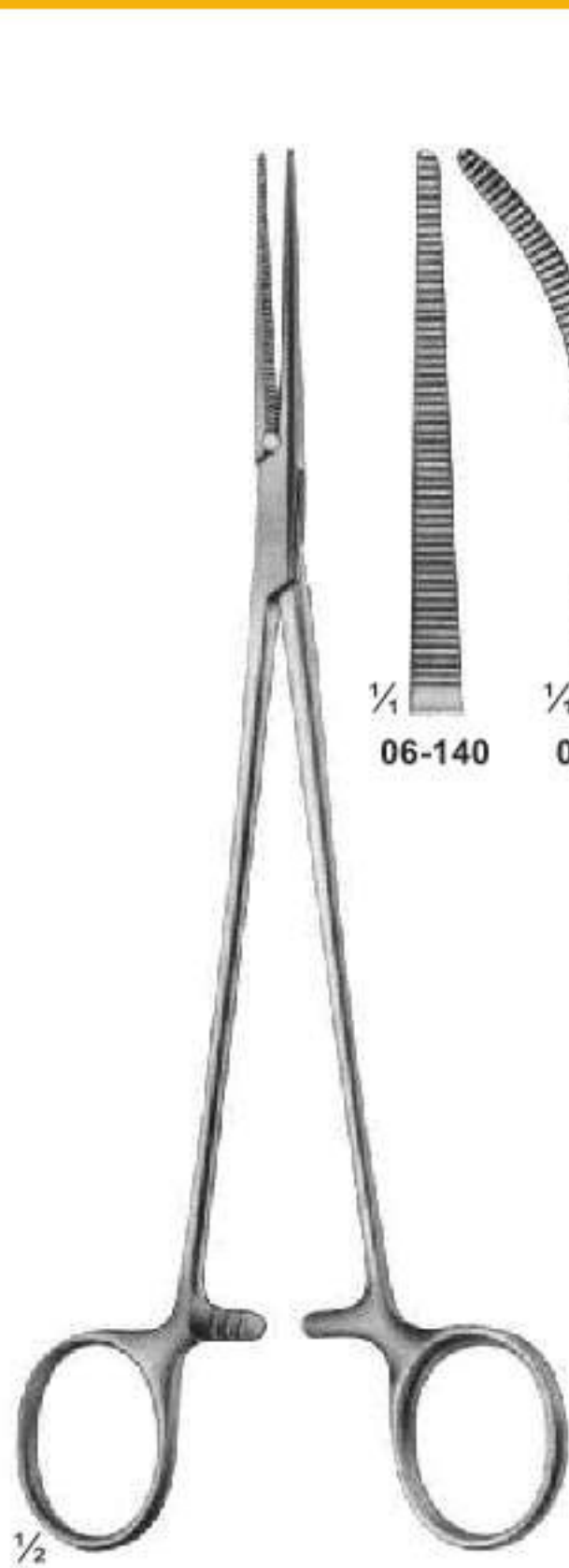

**06-140 - 143**  
HALSTED-MOSQUITO  
200 mm

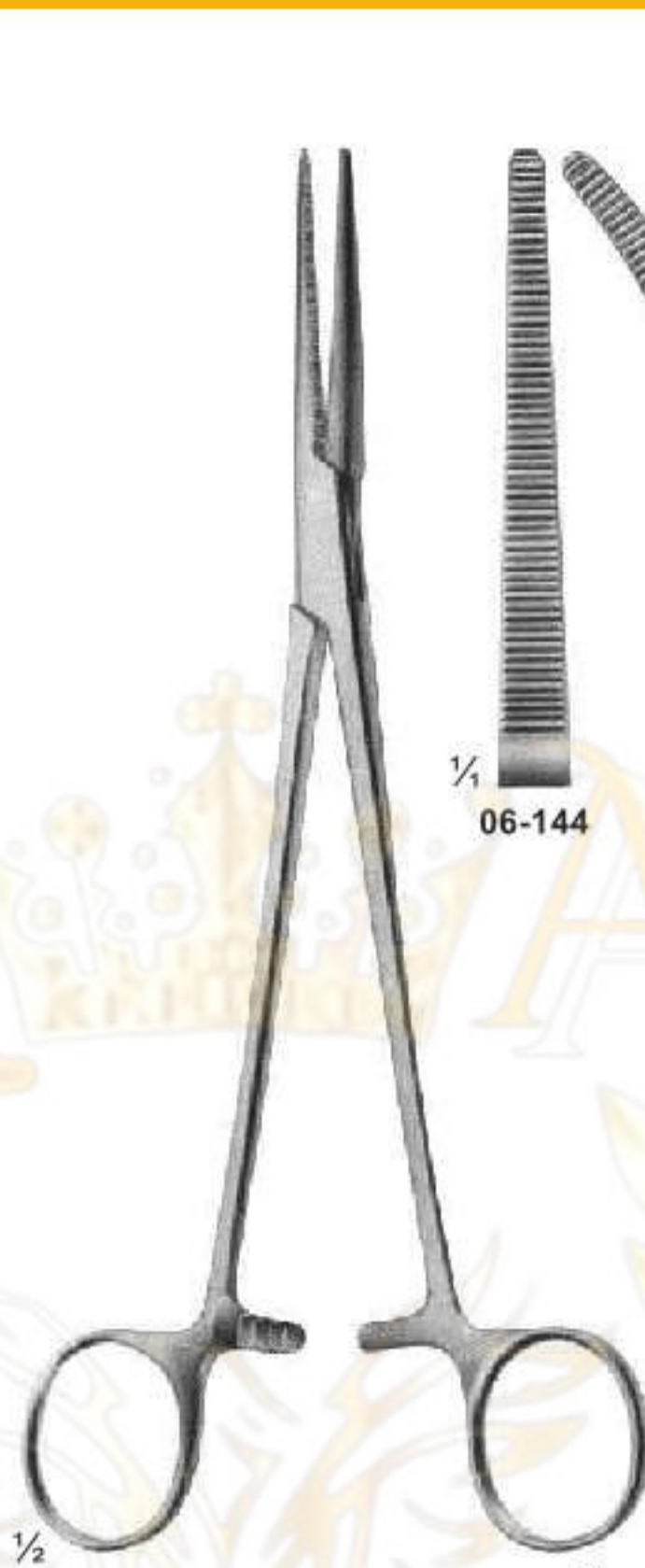
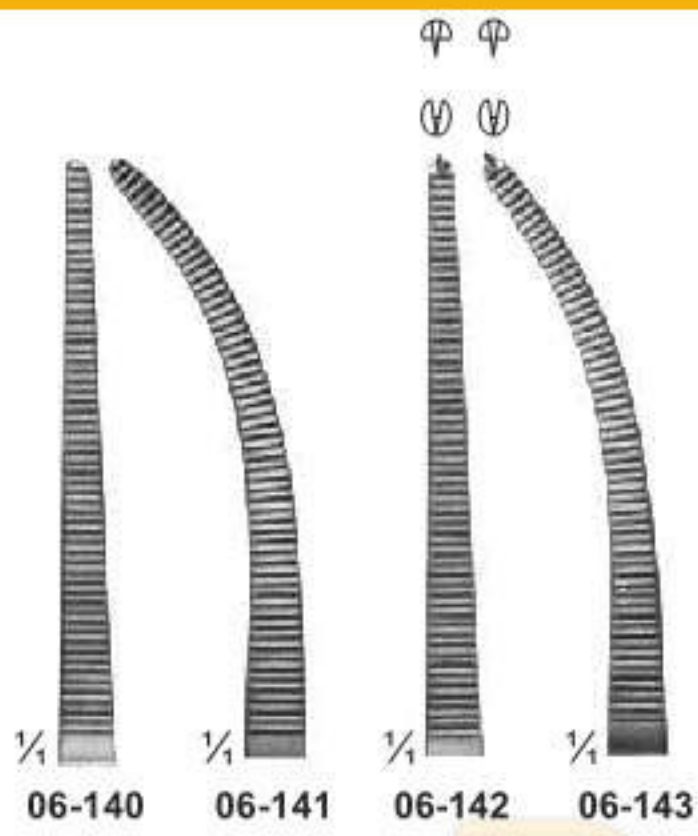

**06-144 - 148**  
HEISS  
200 mm

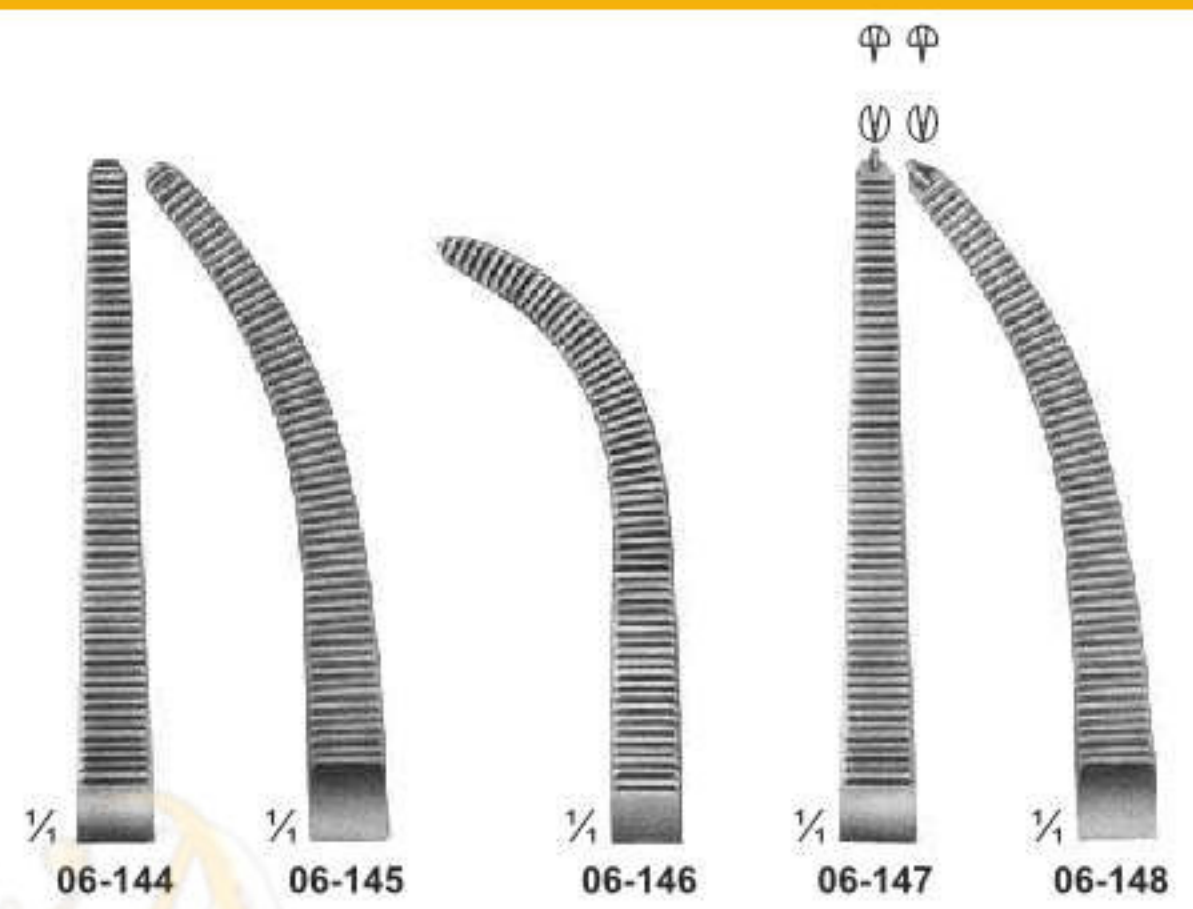

**06-149 - 150**  
HALSTED  
215 mm



**06-151 - 154**  
BENGOLEA  
245 mm

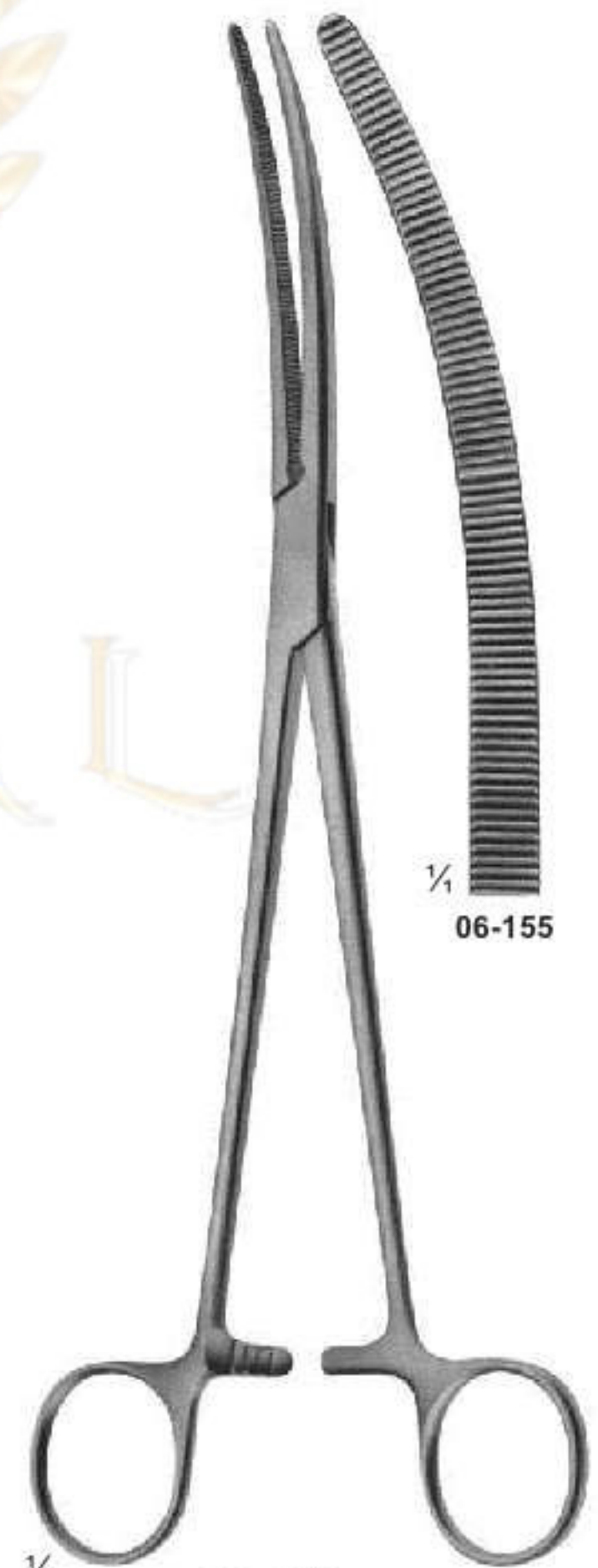

**06-155**  
CRAFOORD  
245 mm



# Haemostatic Forceps

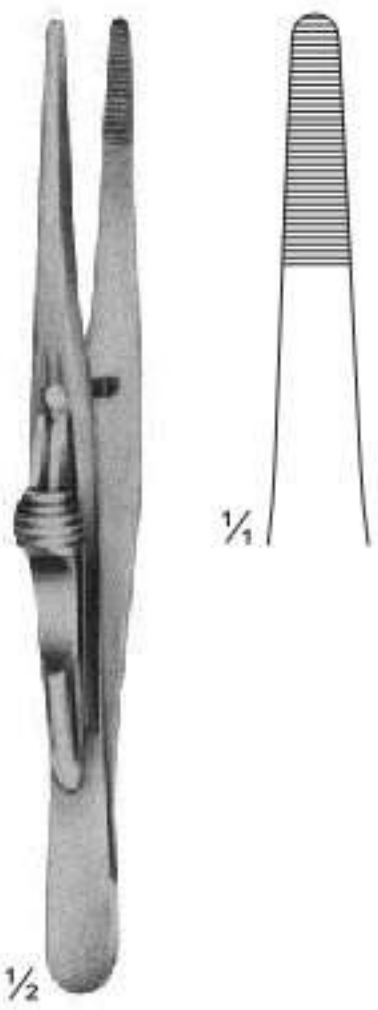

**06-156**  
FRICKE  
Artery forceps  
130 mm



**06-157**  
KRONLEIN  
130 mm

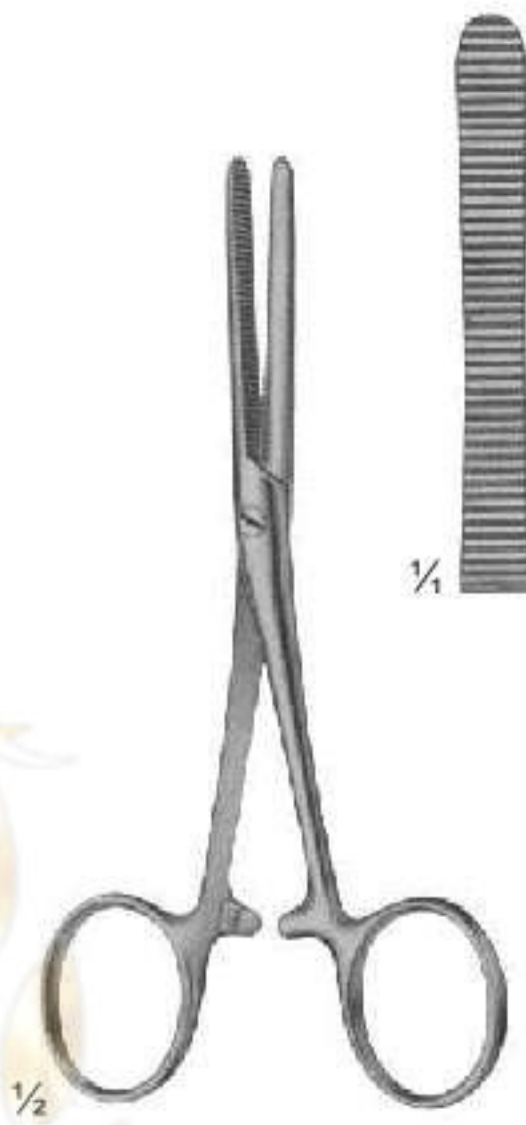

**06-158**  
PEAN  
125 mm



**06-159 - 160**  
PEAN



**06-160**  
140 mm



**06-161**  
PEAN

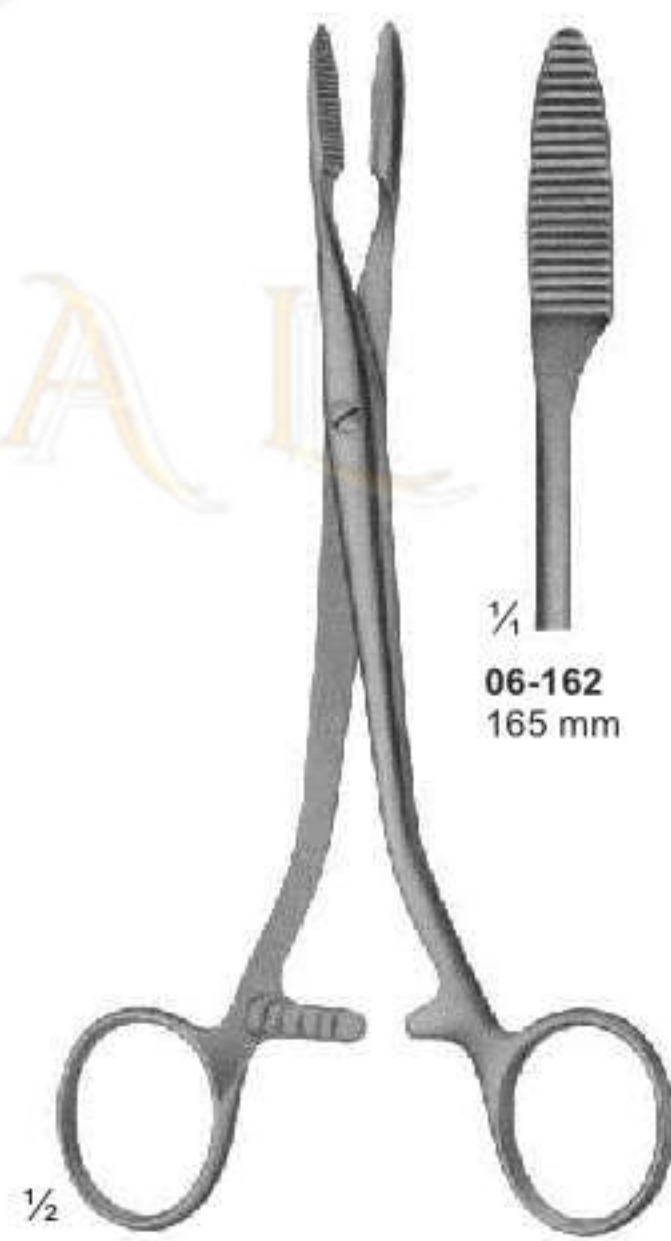

**06-162 - 163**  
PEAN



**06-162**  
165 mm



**06-163**  
185 mm

# Haemostatic Forceps



# Haemostatic Forceps



**06-186 - 191**  
PEAN

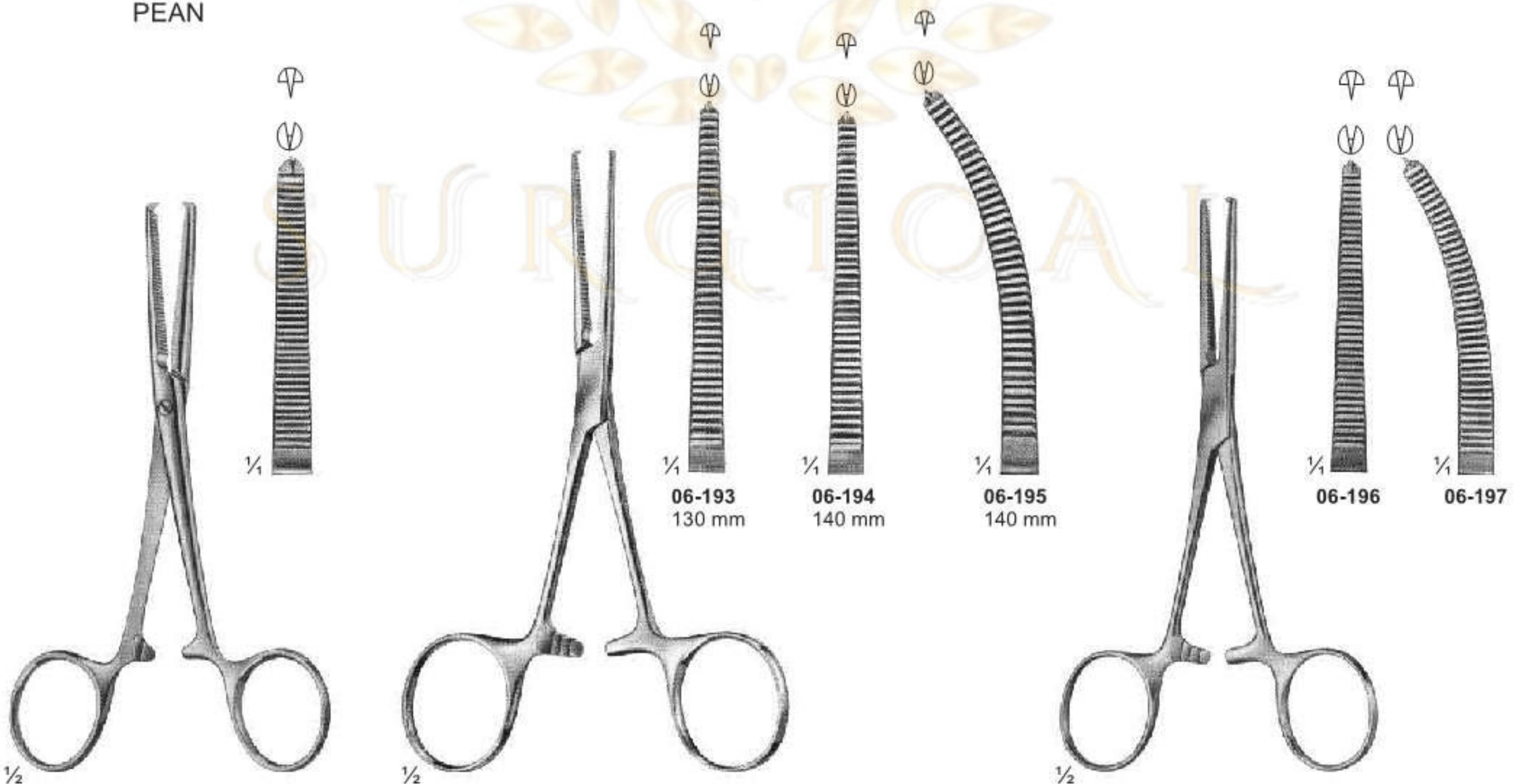

**06-192**  
KOCHER  
Strong Pattern  
145 mm

**06-193 - 195**  
KOCHER

**06-196 - 197**  
ROCHESTER-OCHSNER  
140 mm

# Haemostatic Forceps



**06-198 - 209**  
KOCHER-OCHSNER

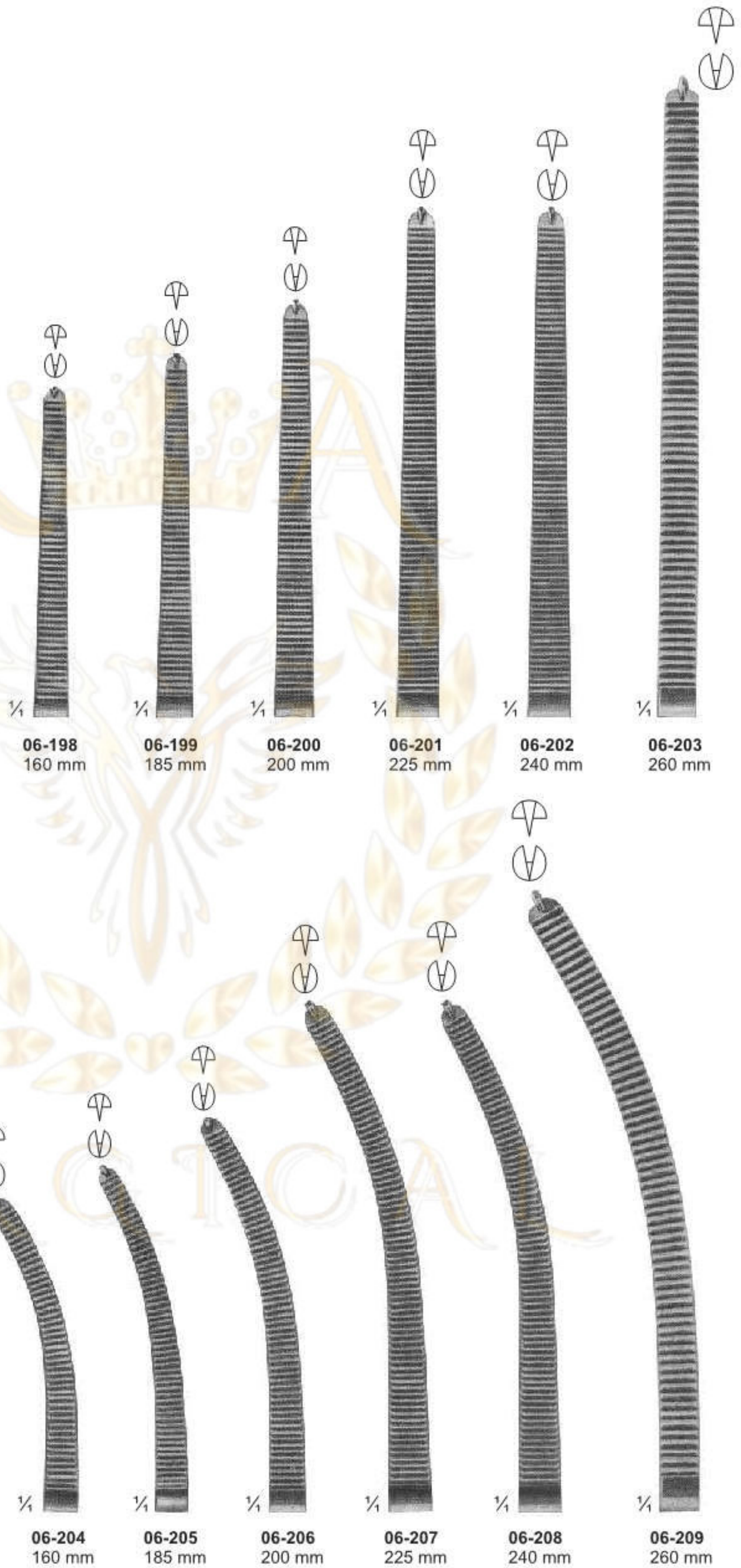

# Haemostatic Forceps, Special Pattern, Tonsil Forceps

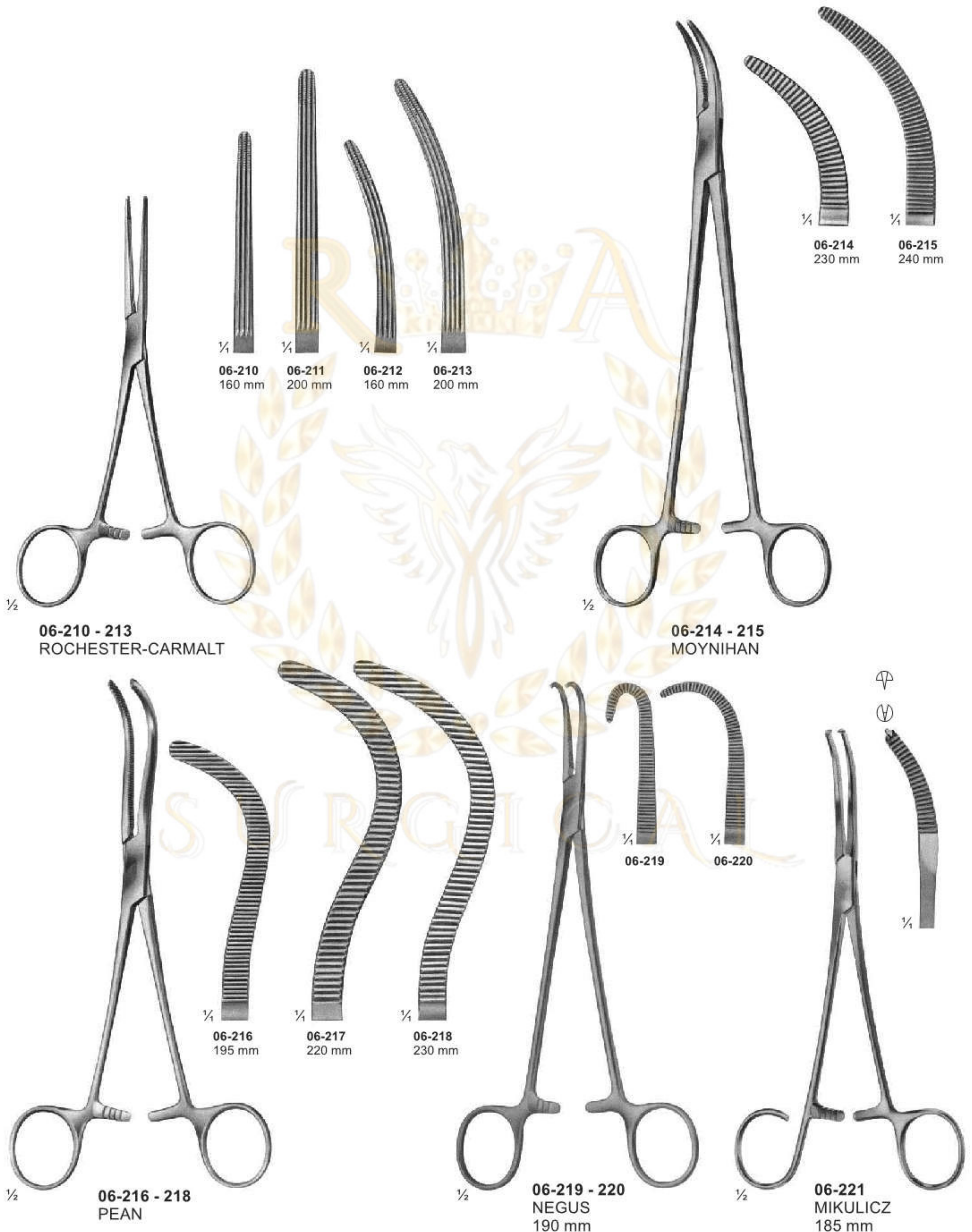

# Dissecting- and Ligature Forceps

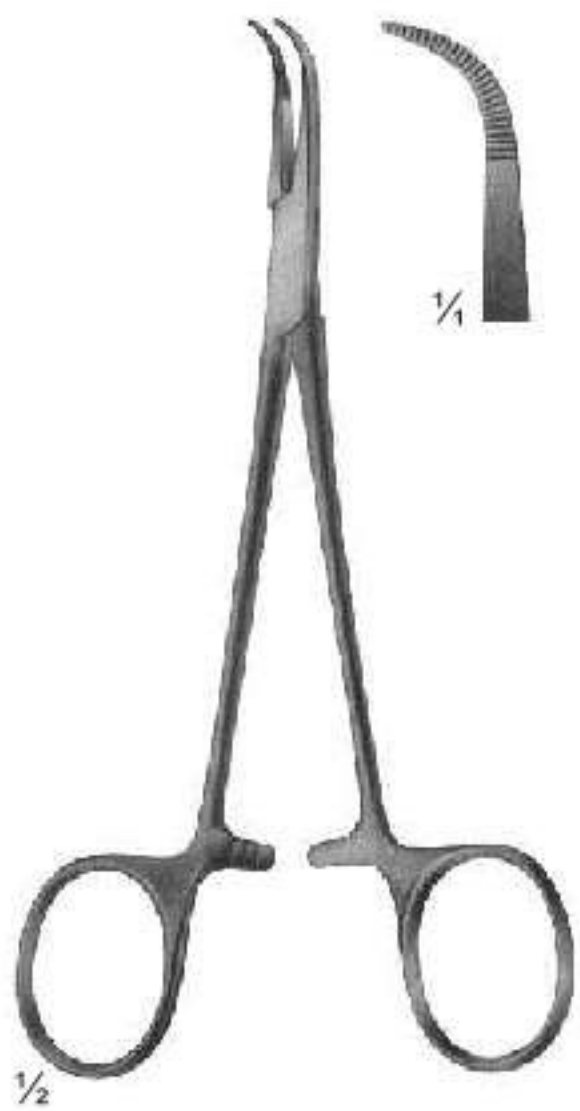

**06-222**  
MICRO-ADSON  
140 mm



**06-223**  
BABY-OVERHOLT  
135 mm



**06-224 - 225**  
BABY-MIXTER

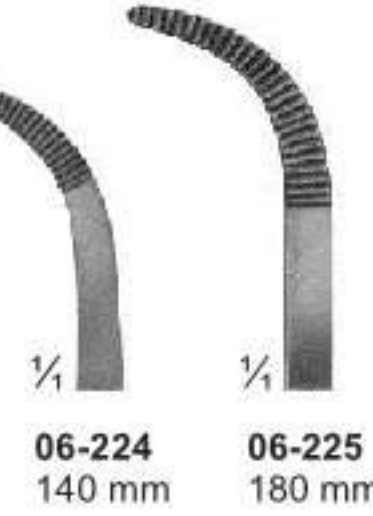

**06-224**  
140 mm

**06-225**  
180 mm

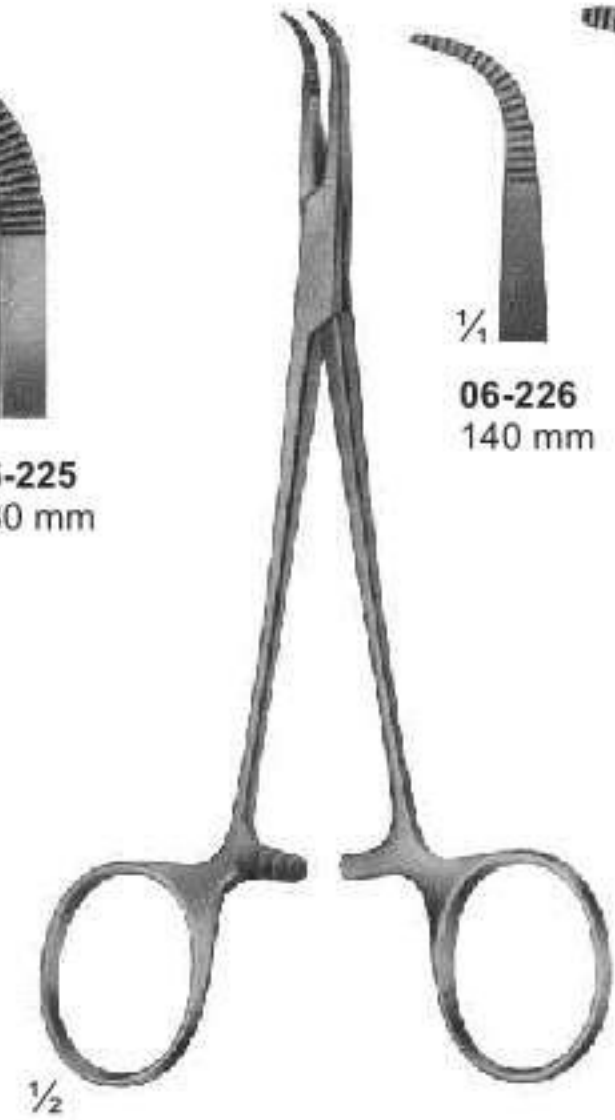

**06-226 - 227**  
BABY-ADSON

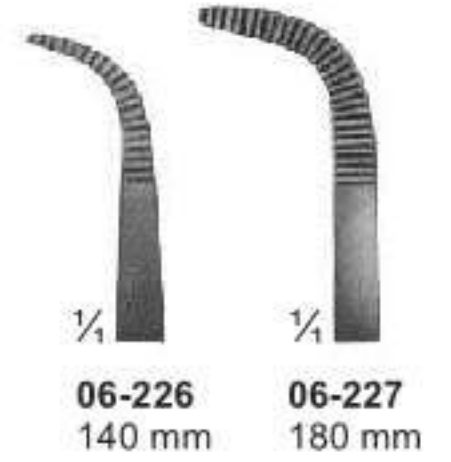

**06-226**  
140 mm

**06-227**  
180 mm



**06-228**  
NISSEN



**06-228**  
185 mm



**06-229 - 230**  
YASARGIL  
195 mm



**06-229**



**06-230**



**06-231**  
OVERHOLT-MIXTER



**06-231**  
205 mm

# Dissecting- and Ligature Forceps

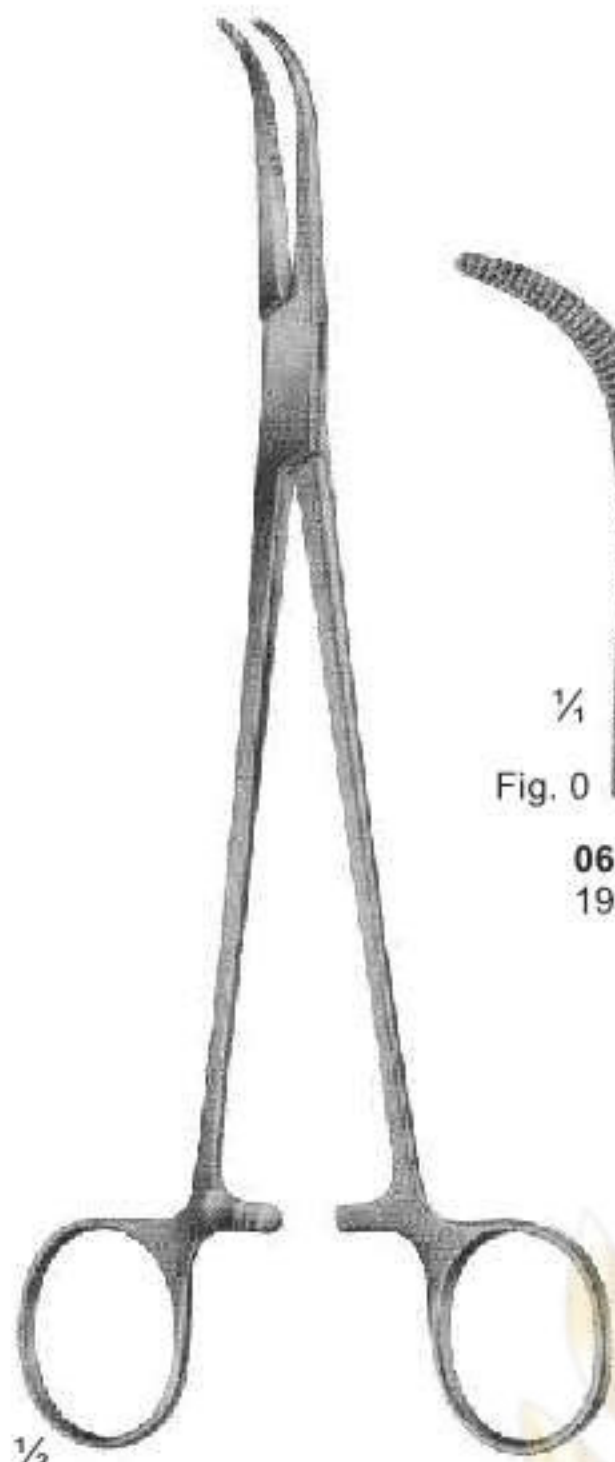

1/2

**06-232 - 243**  
OVERHOLT-GEISSENDOERFER

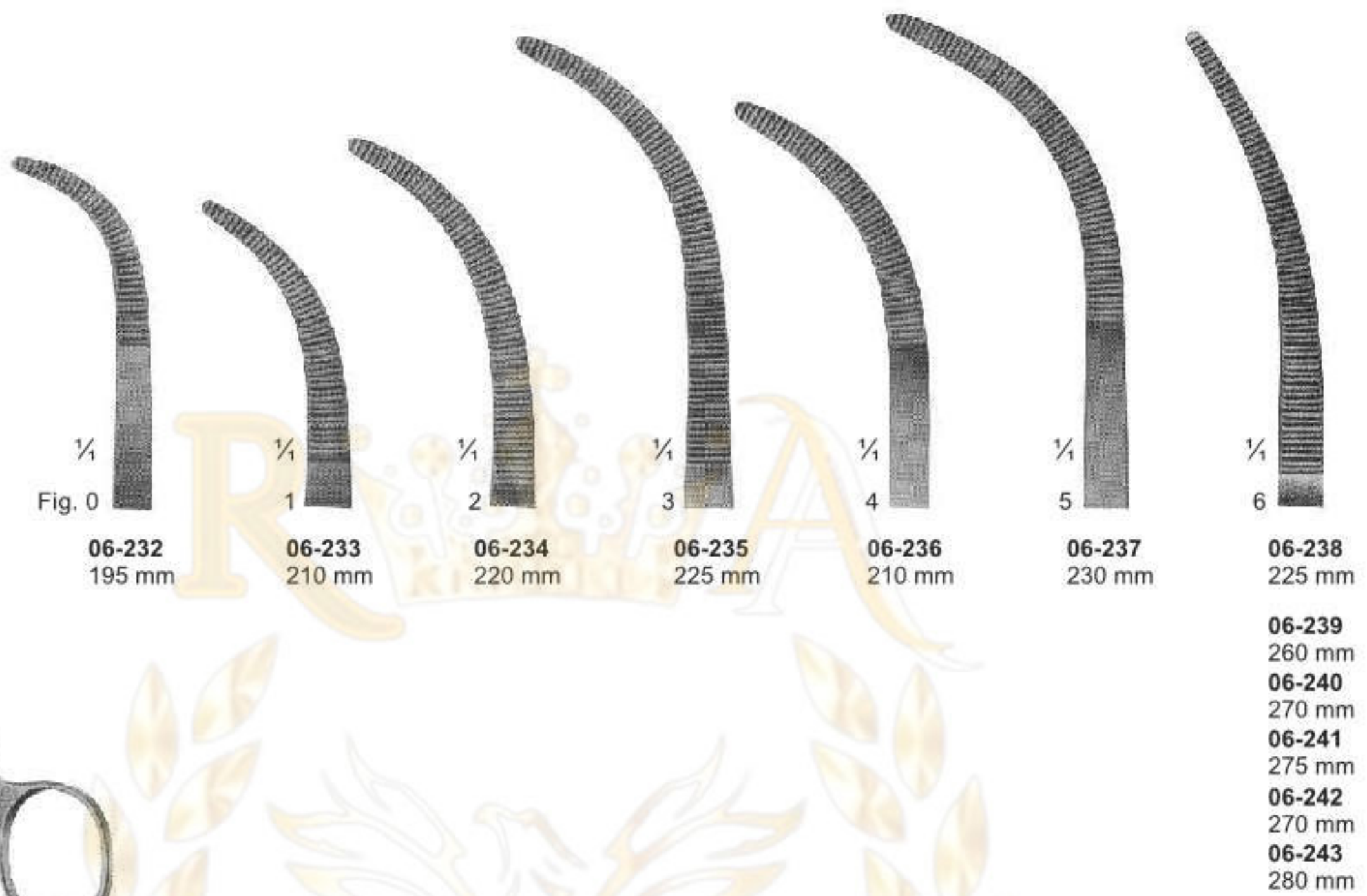

1/2

**06-244 - 251**  
OVERHOLT  
fine pattern





# Dissecting- and Ligature Forceps

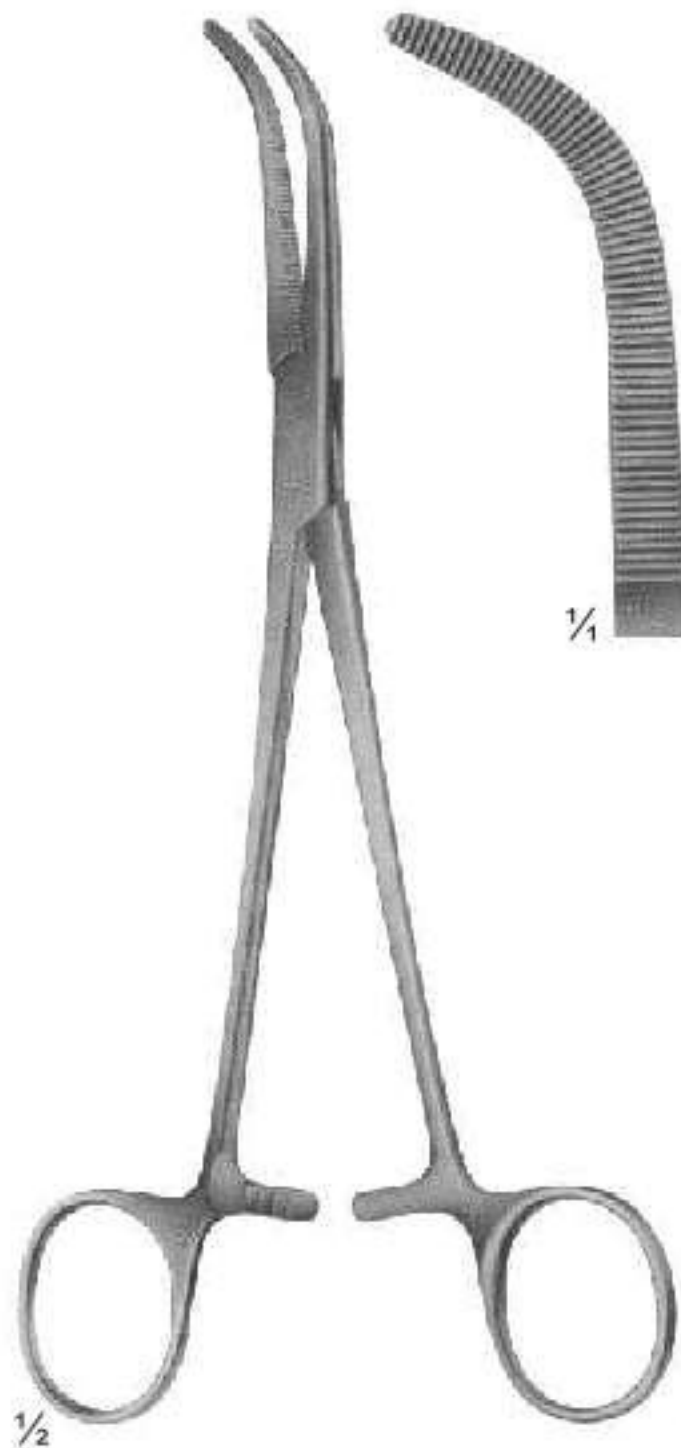

$\frac{1}{2}$   
**06-252**  
 MIXTER-O'SHAUGHNESSY  
 190 mm

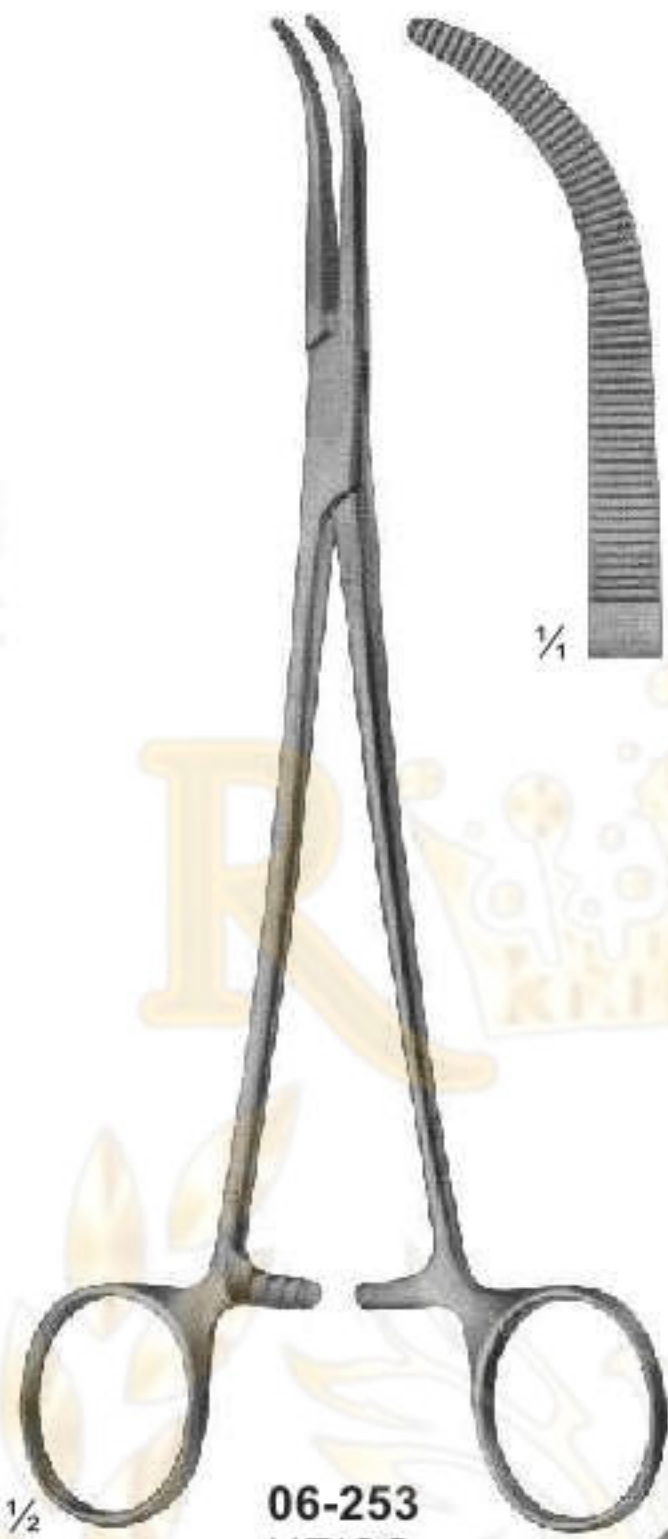

$\frac{1}{2}$   
**06-253**  
 HEISS  
 195 mm

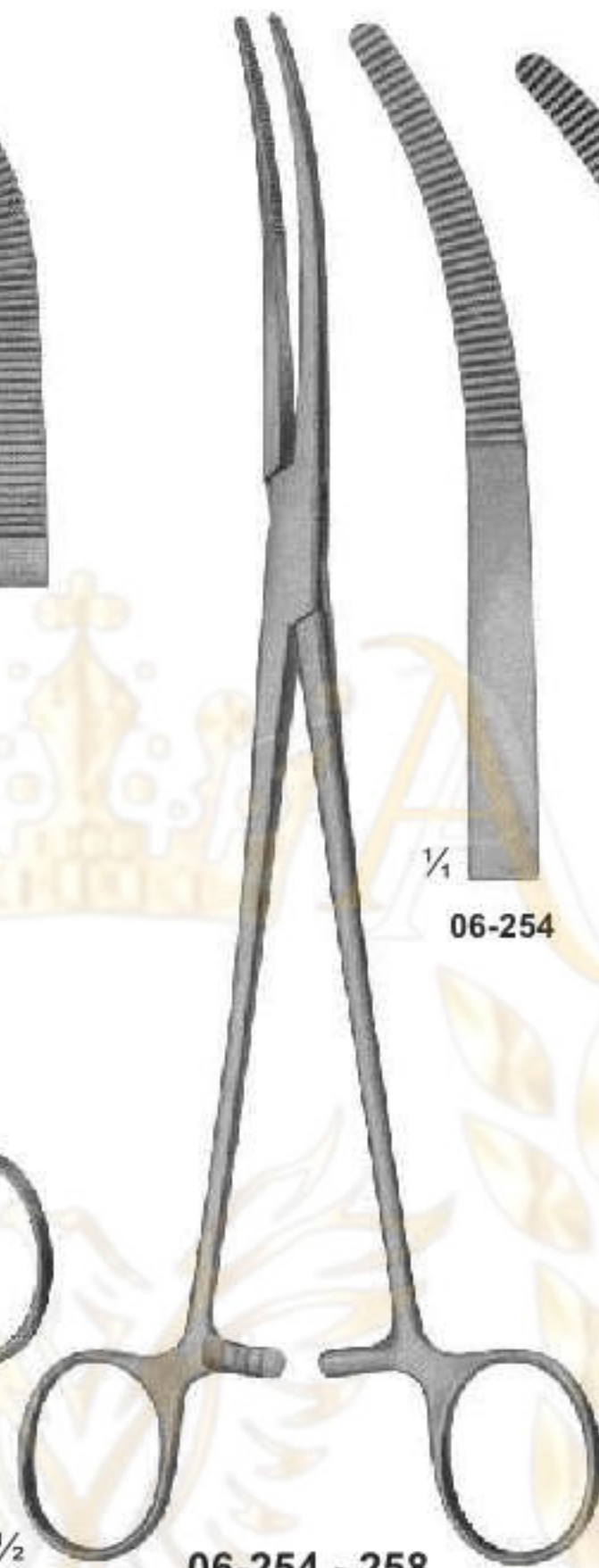

$\frac{1}{2}$   
**06-254 - 258**  
 RUMEL  
 240 mm

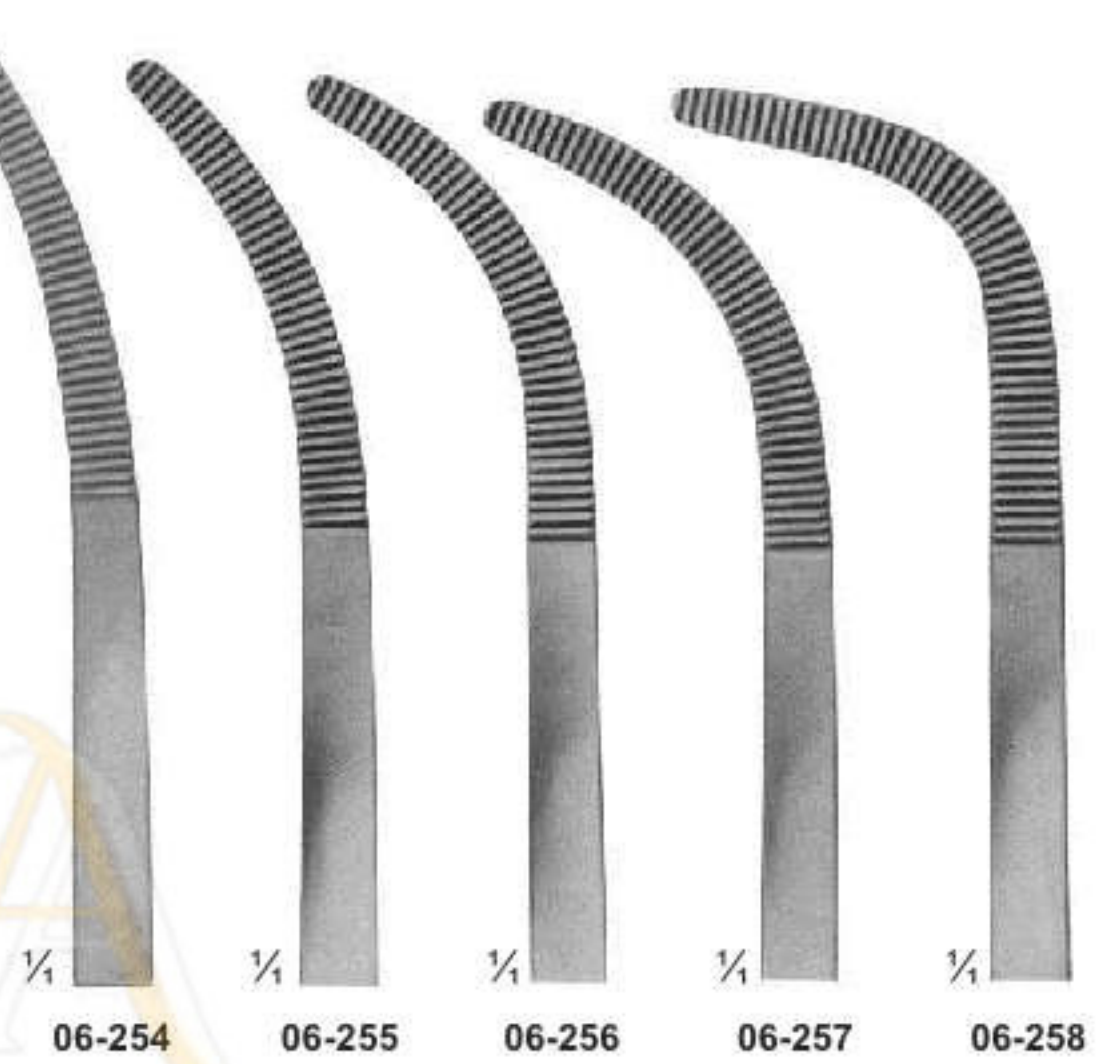

$\frac{1}{4}$  **06-254**    $\frac{1}{4}$  **06-255**    $\frac{1}{4}$  **06-256**    $\frac{1}{4}$  **06-257**    $\frac{1}{4}$  **06-258**

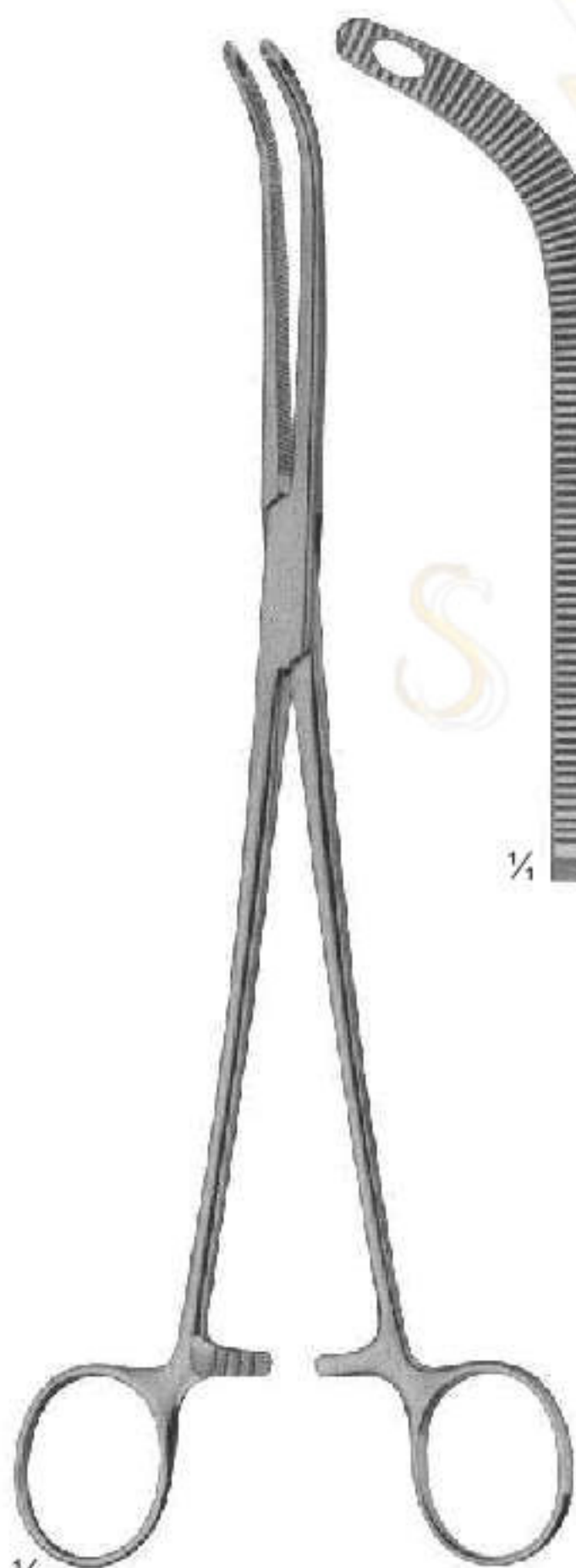

$\frac{1}{2}$   
**06-259**  
 FINOCCHETTO  
 245 mm

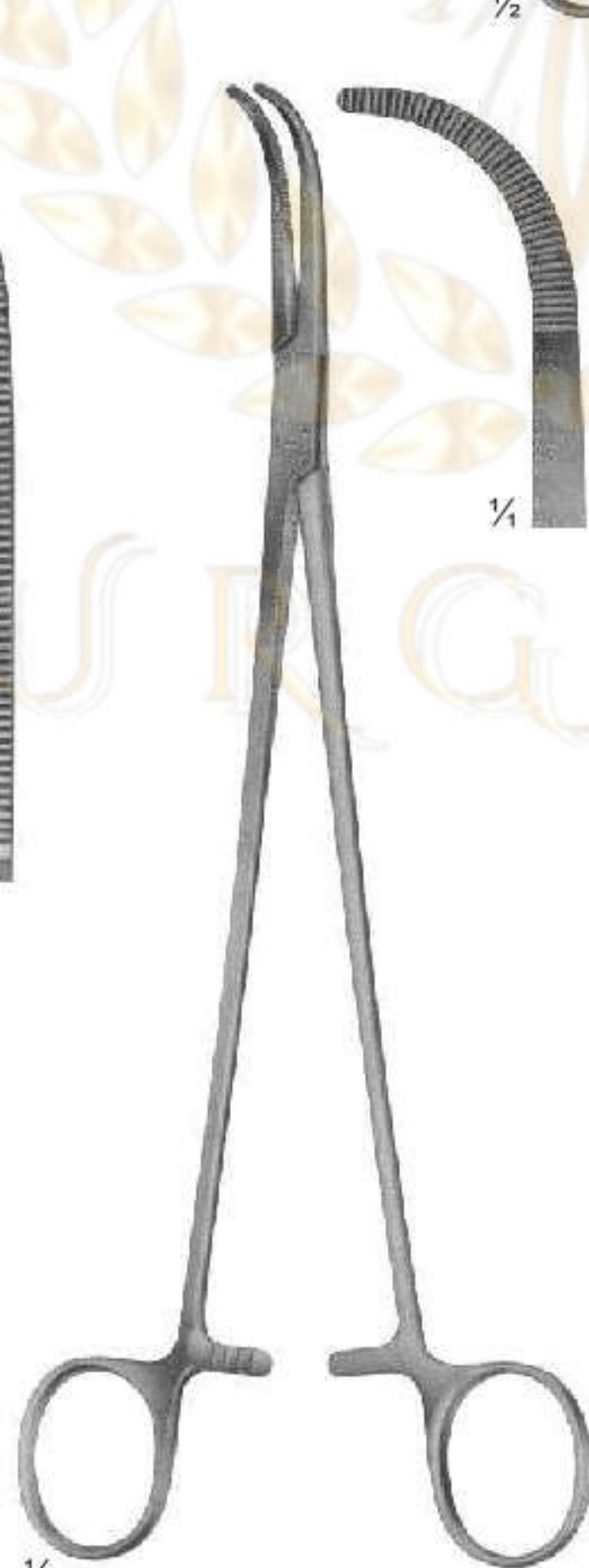

$\frac{1}{2}$   
**06-260**  
 MIXTER  
 230 mm



$\frac{1}{3}$   
**06-261**  
 LAWRENCE  
 270 mm

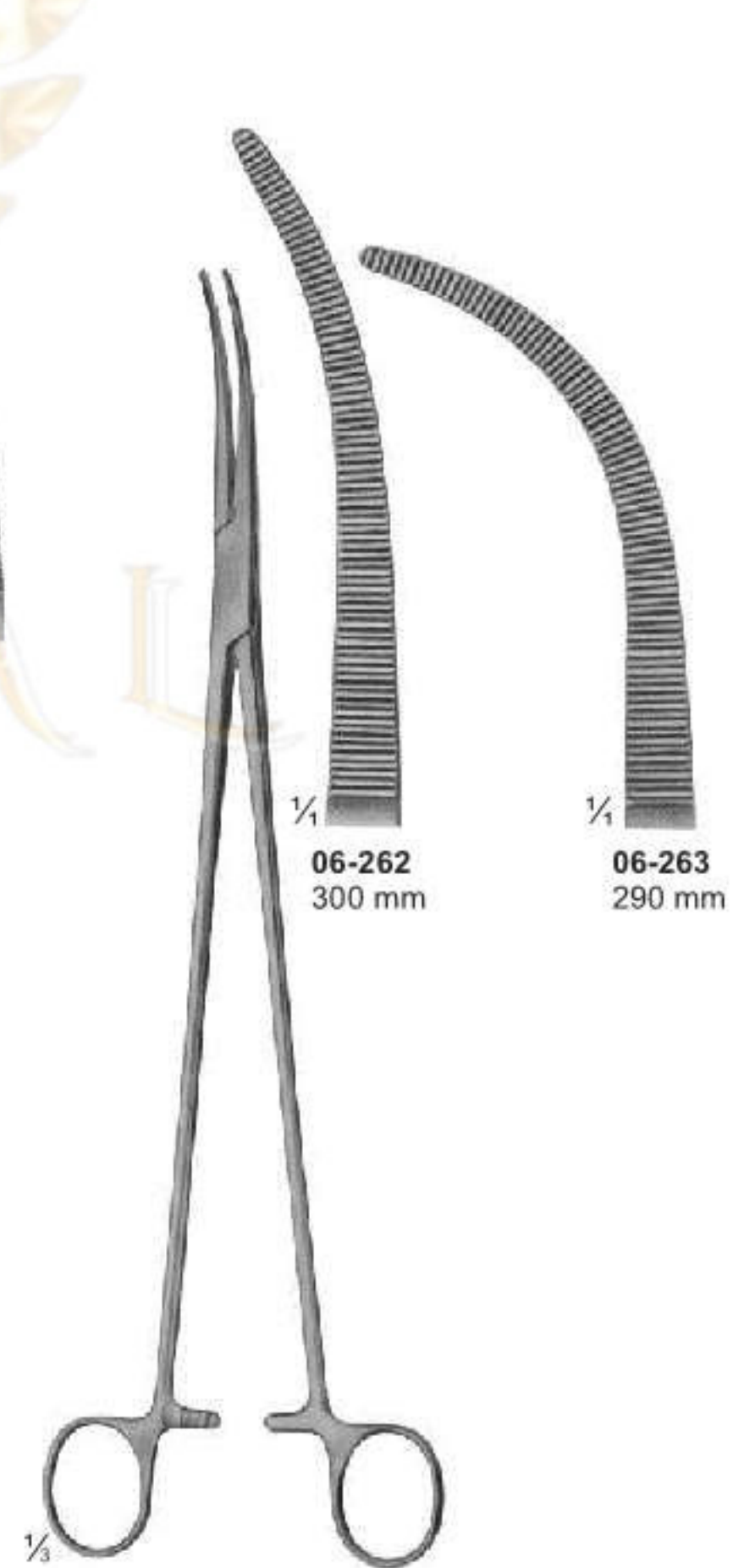

$\frac{1}{3}$   
**06-262 - 263**  
 ZENKER

# Dissecting- and Ligature Forceps

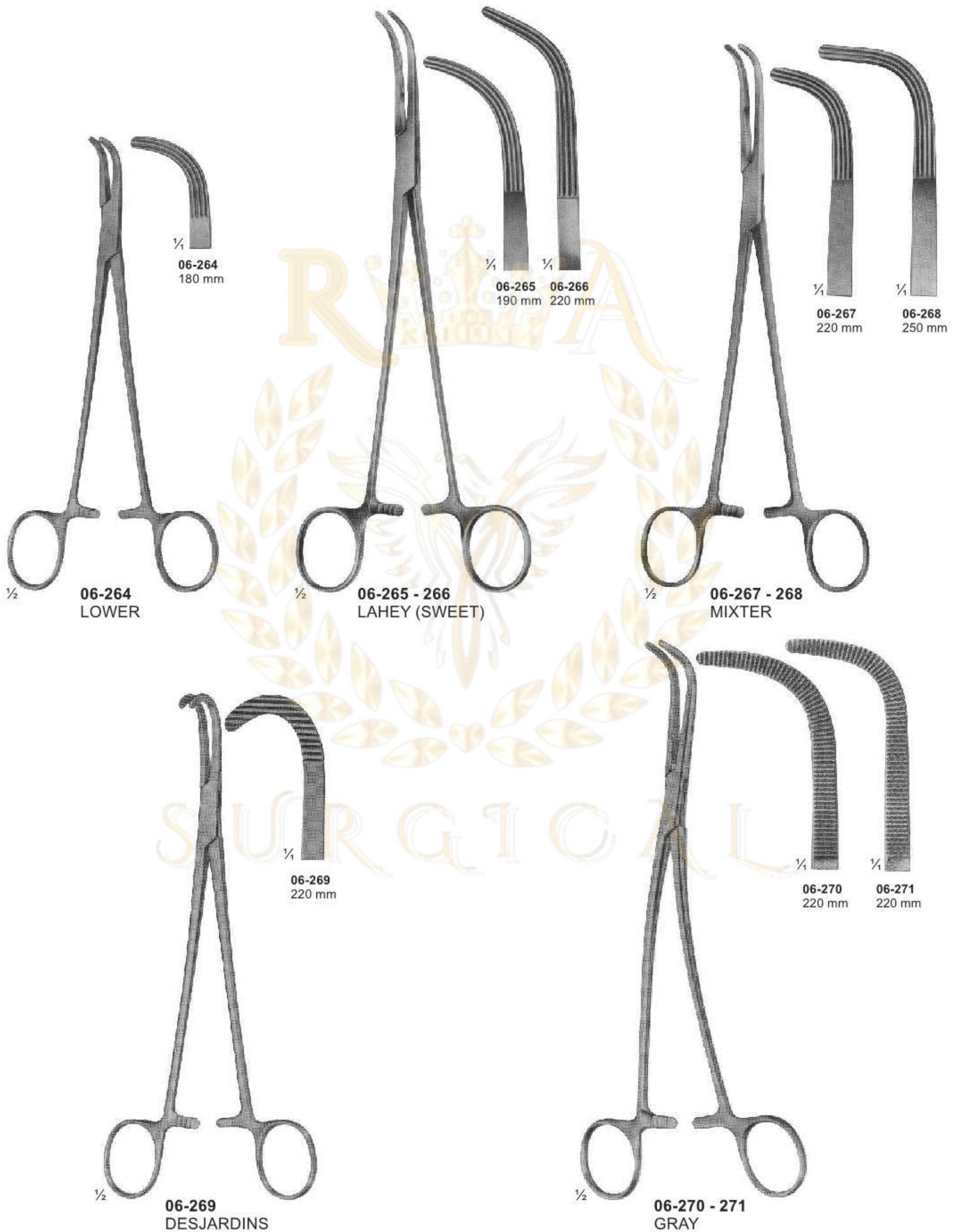

# Peritoneum Forceps

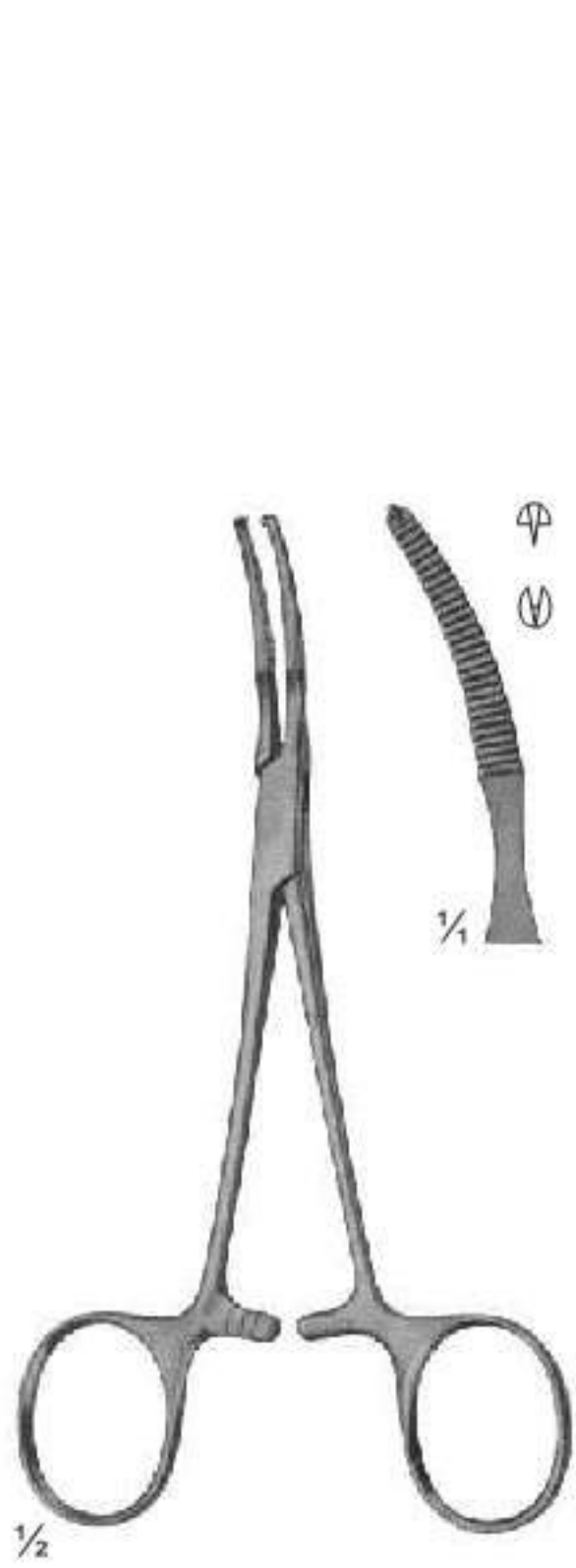

**06-272**  
BABY-MIKULICZ  
140 mm



**06-273**  
MIKULICZ  
185 mm

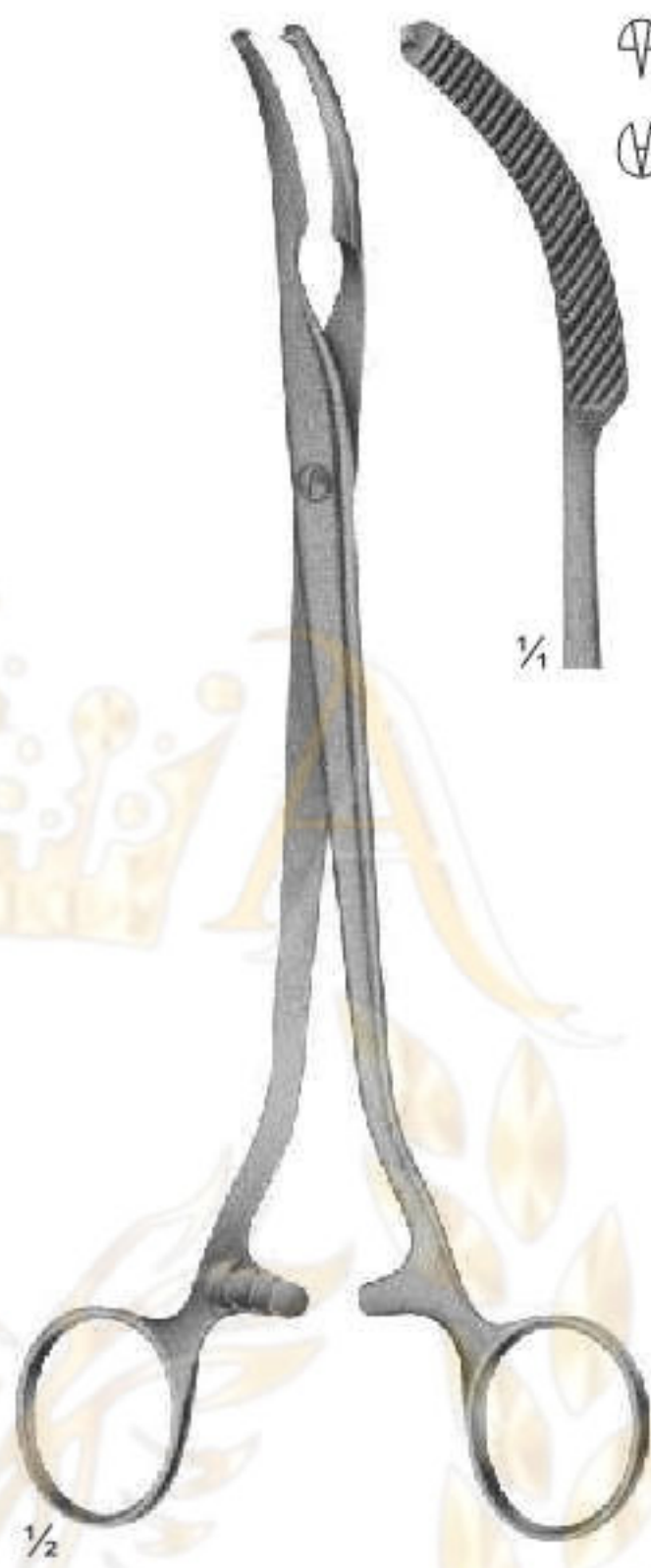

**06-274**  
MIKULICZ  
205 mm

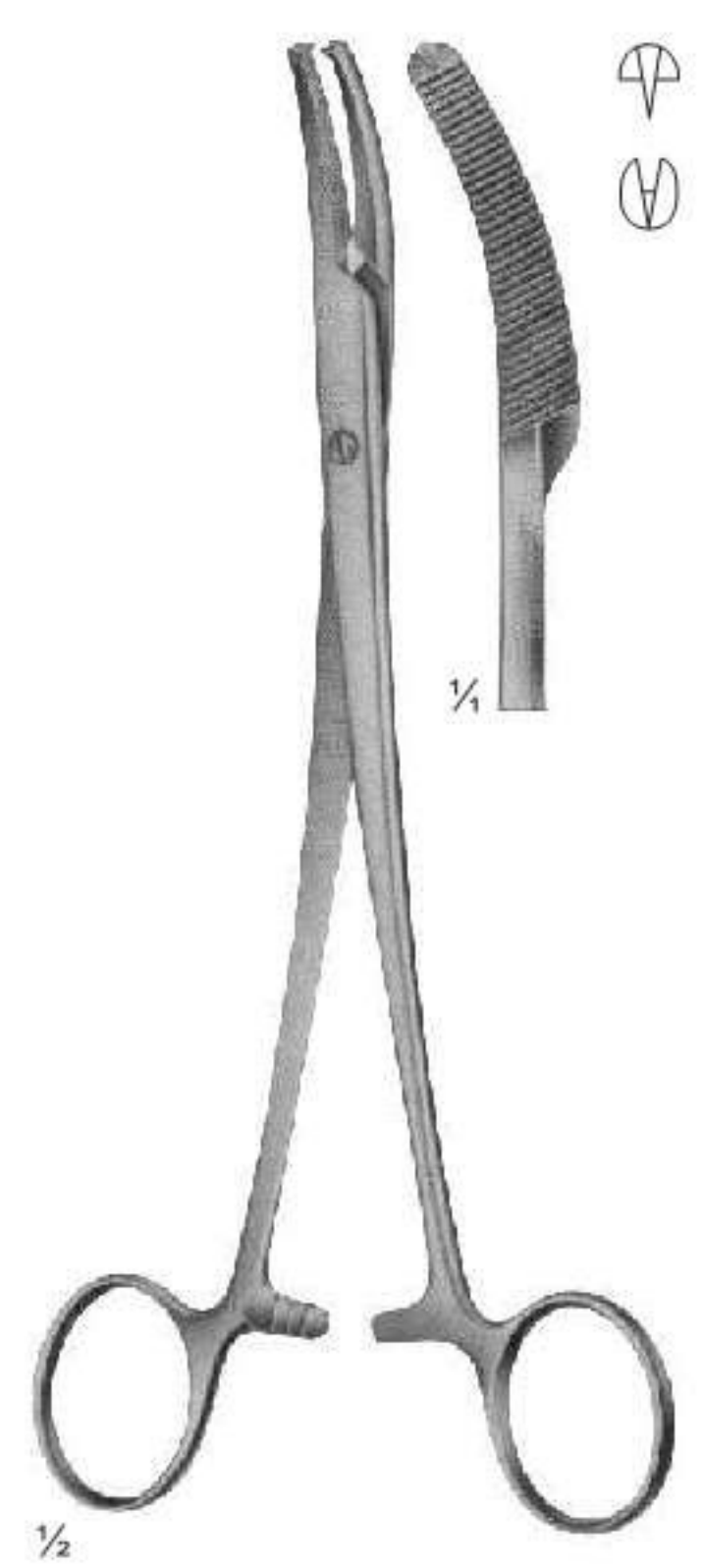

**06-275**  
MIKULICZ  
200 mm



**06-276**  
MIKULICZ  
205 mm

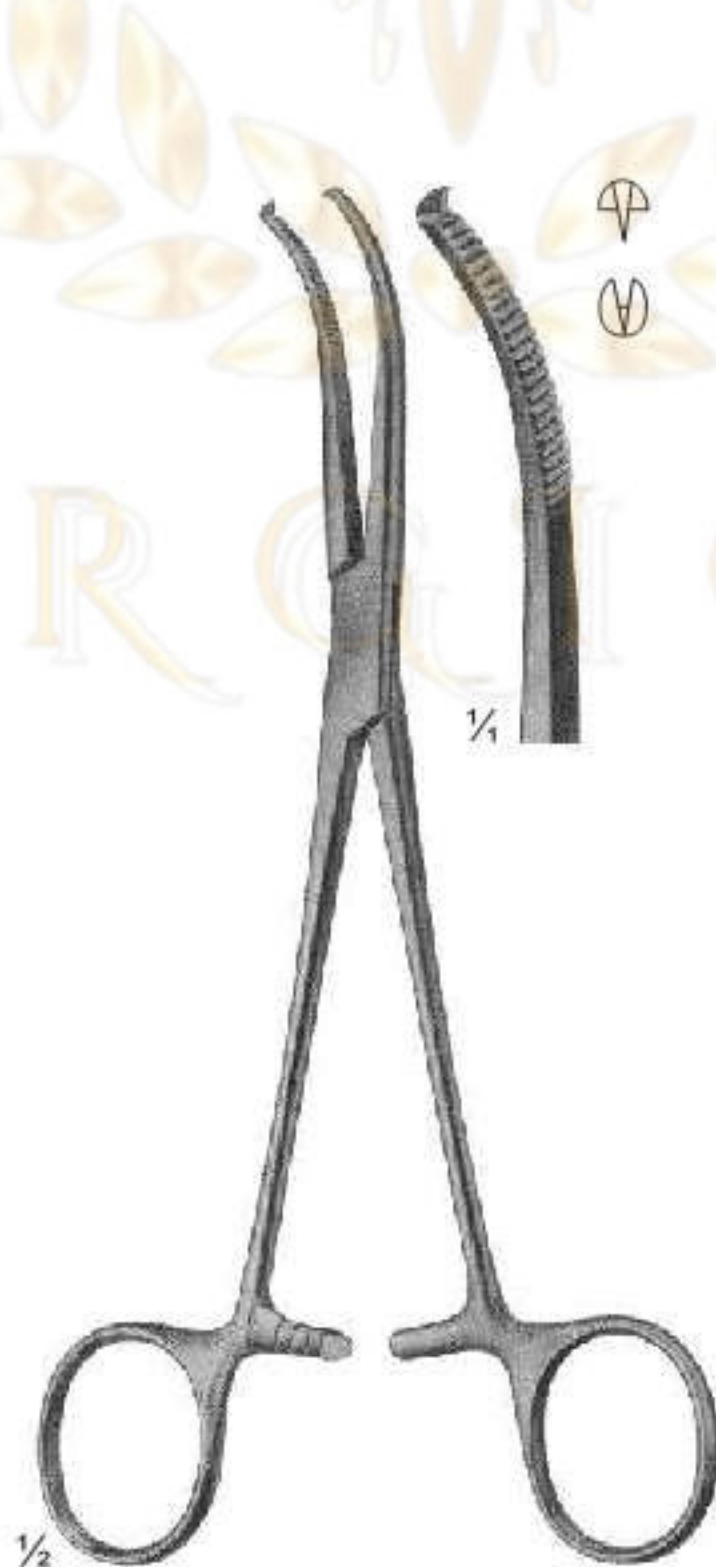

**06-277**  
MIKULICZ  
185 mm

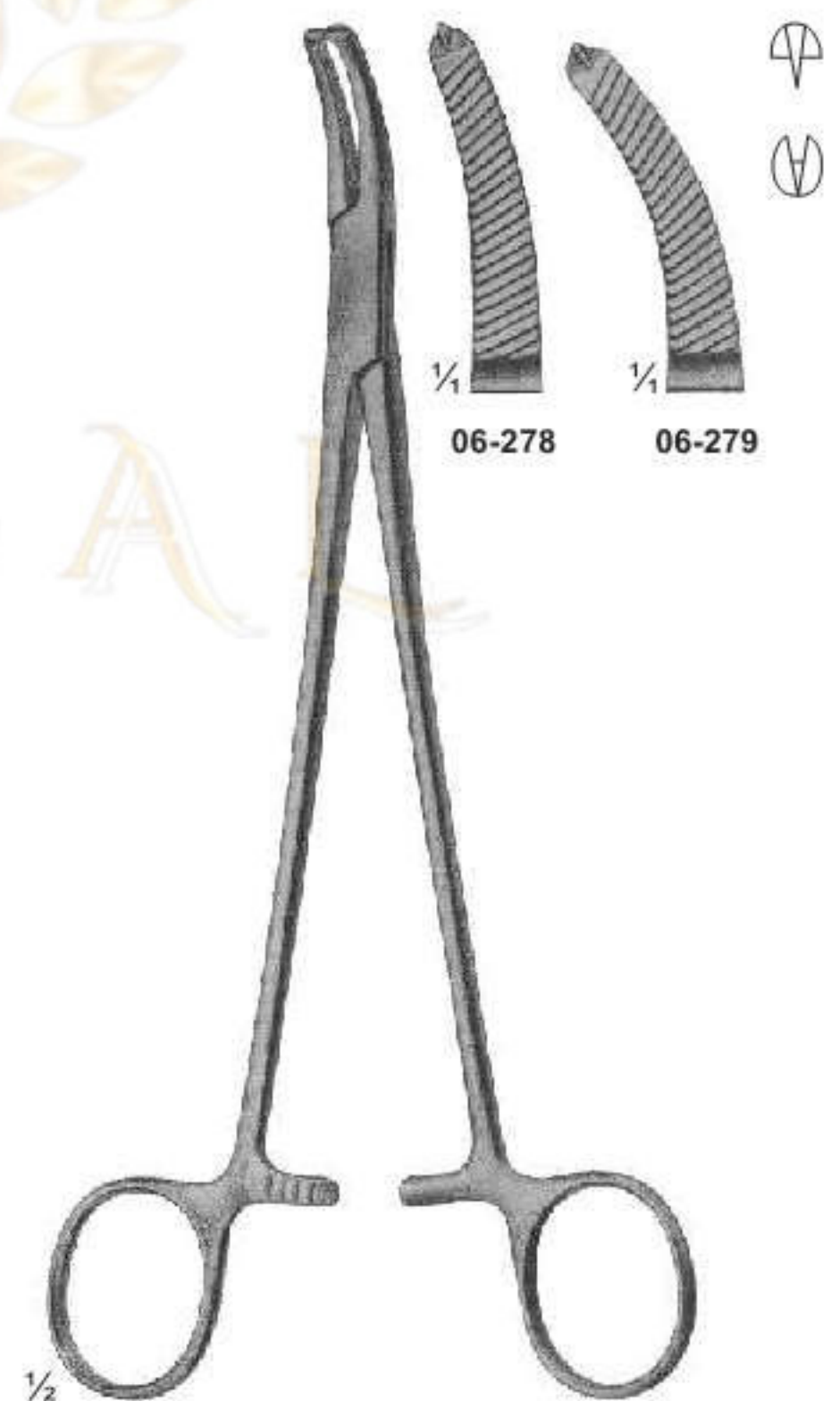

**06-278 - 279**  
FAURE  
205 mm

# Hysterectomy Forceps

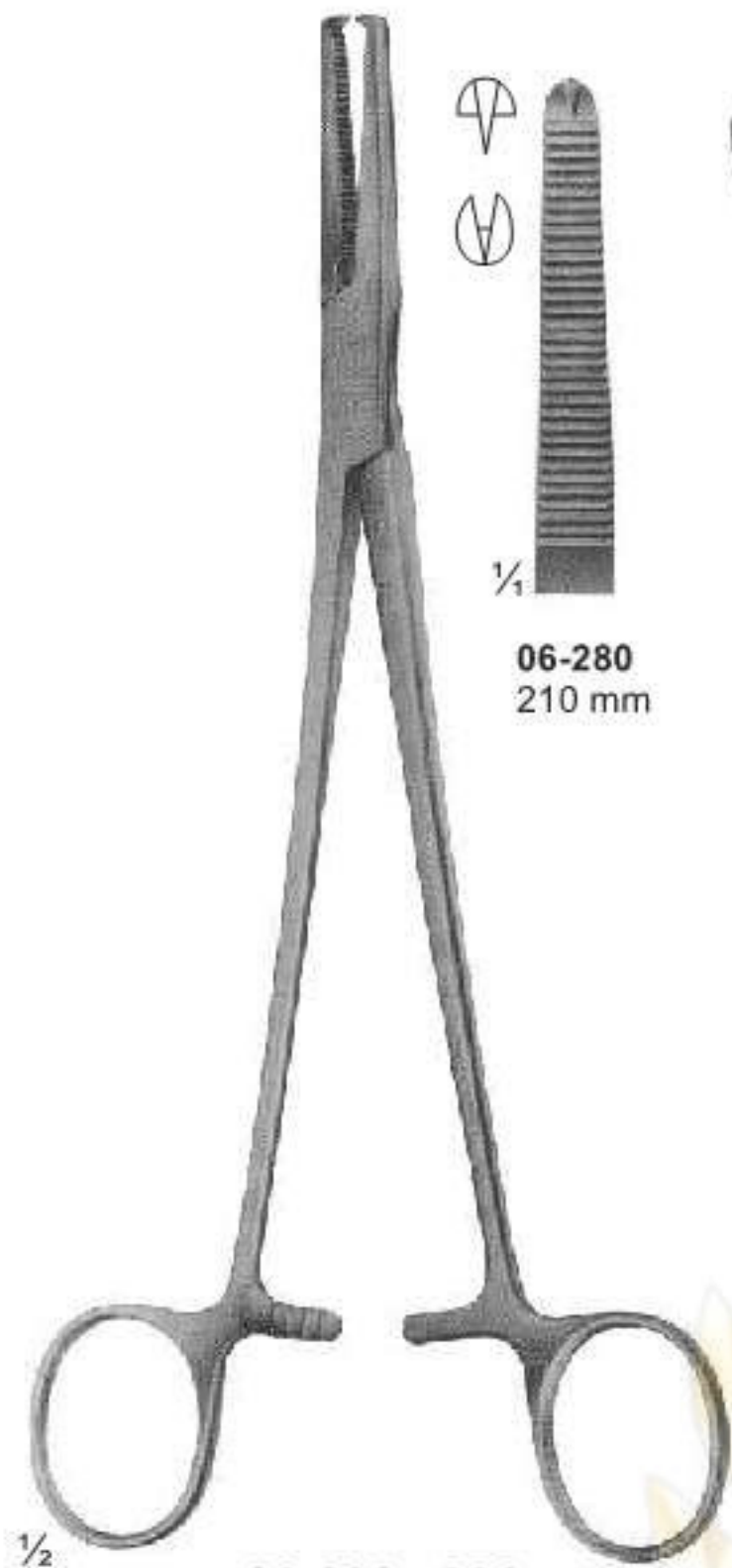

**06-280 - 281**  
PHANEUF

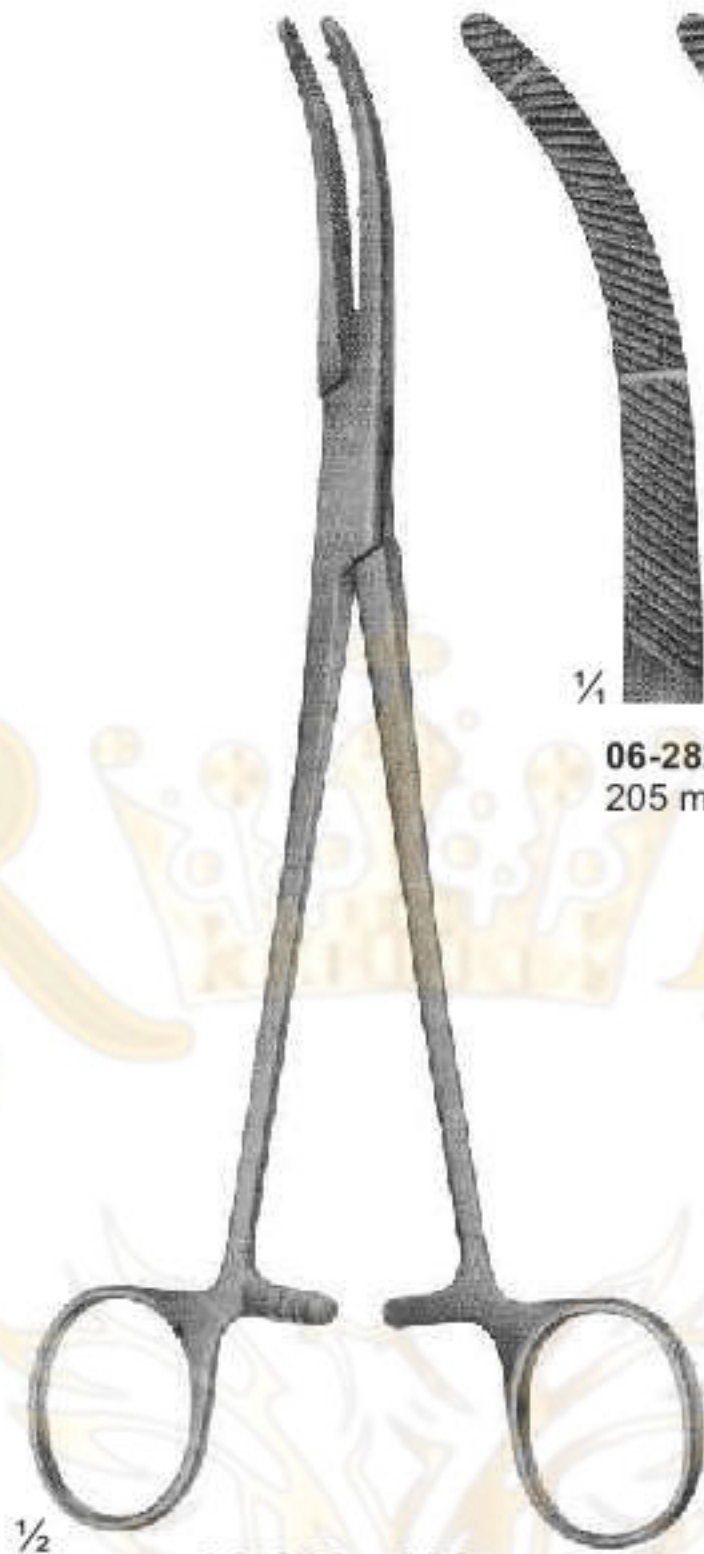
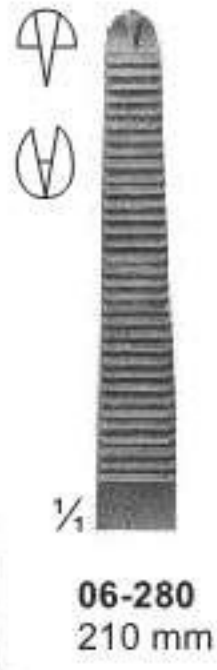

**06-282 - 283**  
HEANEY modif.



**06-284**  
HEANEY

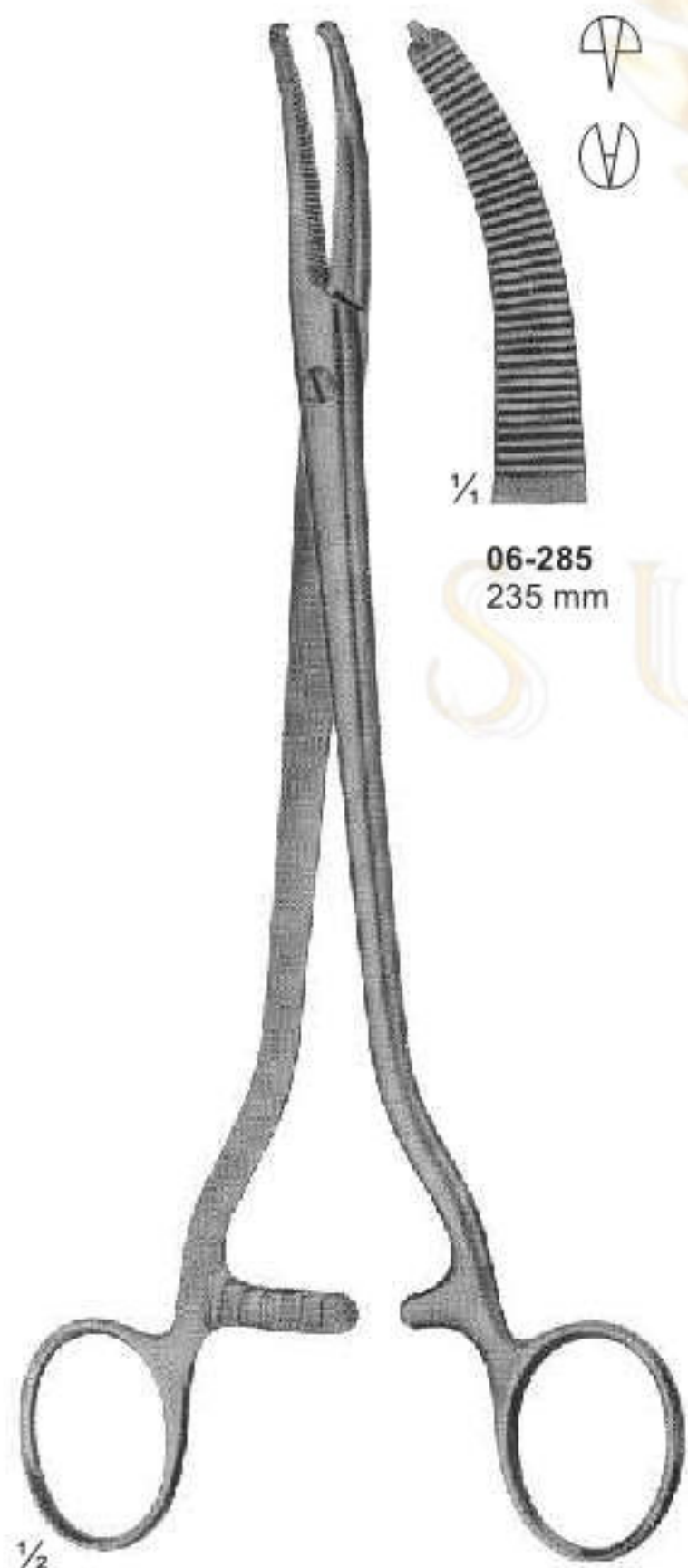

**06-285**  
WERTHEIM

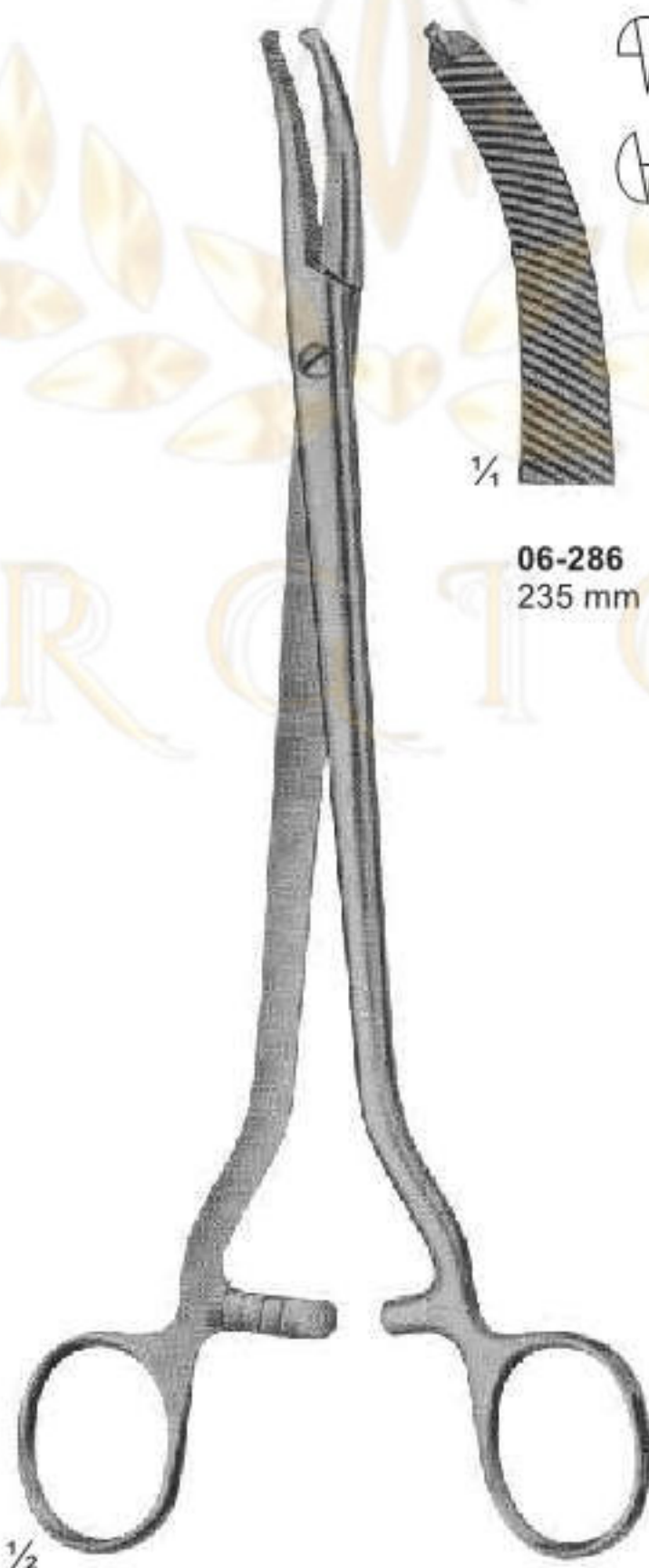

**06-286**  
WERTHEIM



**06-287**  
WERTHEIM



# Hysterectomy Forceps and Vaginal Clamps



# Hysterectomy Forceps and Vaginal Clamps and Compression Forceps



1/2  
**06-296**  
**WERTHEIM**  
 Hysterectomy Forceps  
 255 mm

1/2  
**06-297**  
**WERTHEIM**  
 Parametrium Clamp  
 260 mm

1/2  
**06-298 - 300**  
**DICK**

1/4  
**06-298** 255 mm  
**06-299** 265 mm  
**06-300** 275 mm

# Hysterectomy Forceps and Vaginal Clamps and Compression Forceps

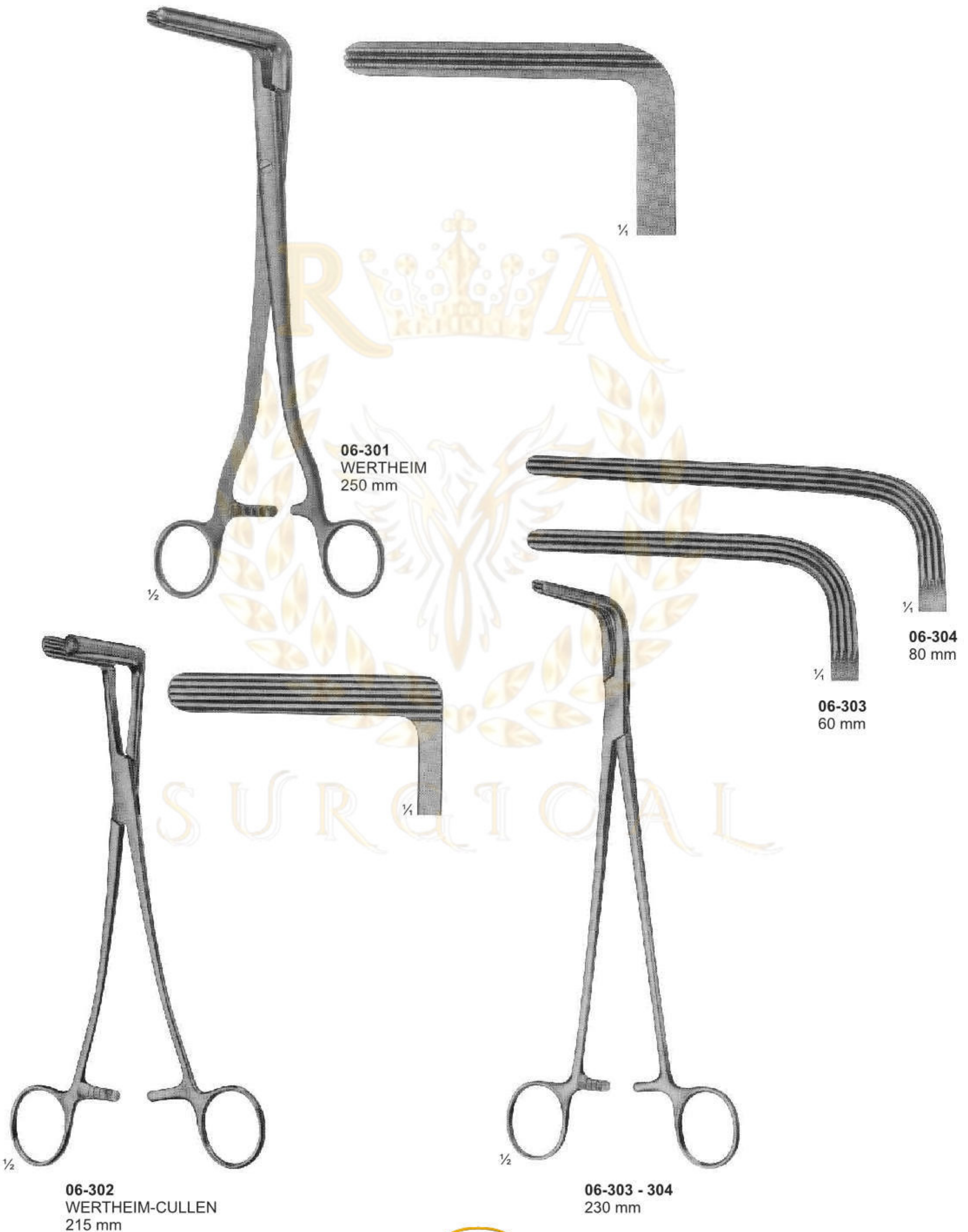

# Needle Holders For Micro Surgery



**07-101**  
ROHRSCHEIDER  
With copper inserts  
100 mm



**07-102**  
KALT  
With catch  
135 mm



**07-103**  
ARRUGA  
With catch  
135 mm



**07-104 - 105**  
CASTROVIEJO  
With catch  
145 mm



**07-106 - 107**  
CASTROVIEJO  
With Catch  
160 mm

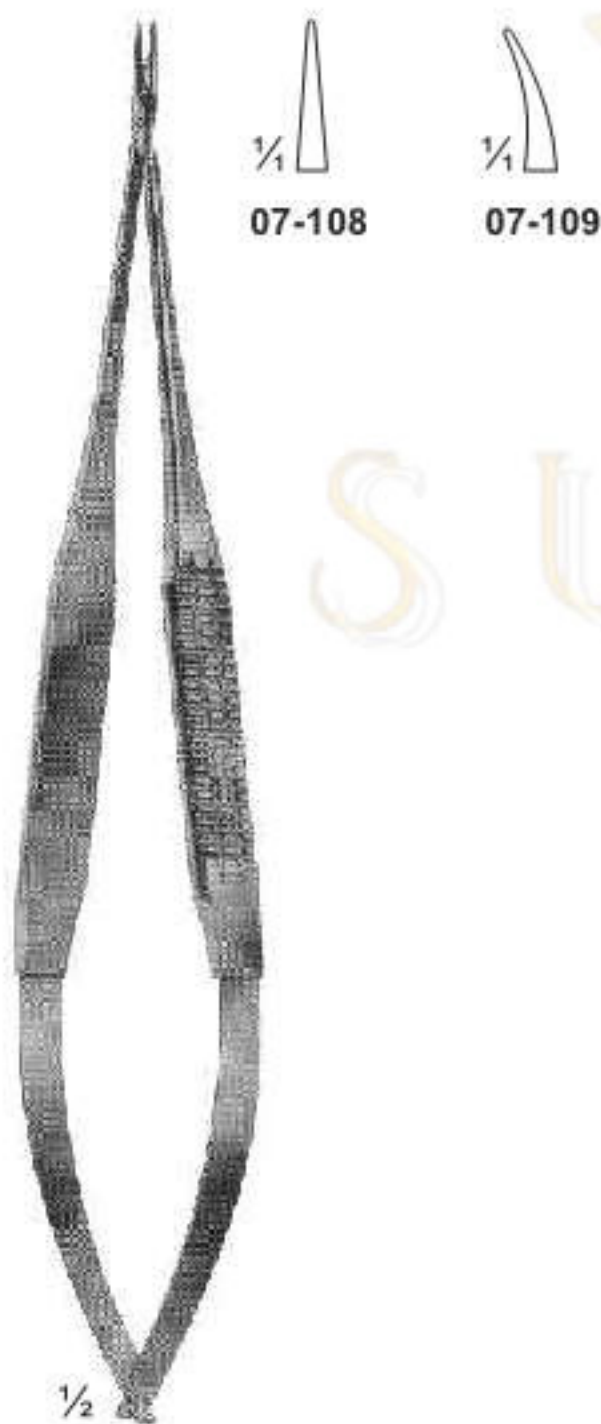

**07-108 - 109**  
Without catch  
185 mm



**07-110 - 111**  
JACOBSON  
185 mm



**07-112**  
Without catch  
195 mm



**07-113 - 114**  
YASARGIL  
With catch  
200 mm



# Micro Needle Holders With Round Handles



**07-115 116**  
BARRAQUER  
Without catch



**07-117 - 118**  
BARRAQUER  
Without catch  
120 mm



**07-119 - 120**  
BARRAQUER  
With catch  
120 mm



**07-121 - 122**  
BARRAQUER  
With Catch  
150 mm



**07-123**  
MULLER  
With Locking  
Mechanism  
145 mm



**07-124 - 125**  
BROCK  
Without catch  
150 mm



**07-126 - 127**  
YASARGIL  
200 mm



**07-128 - 129**  
YASARGIL  
225 mm



**07-130**  
YASARGIL  
245 mm

# Needle Holders

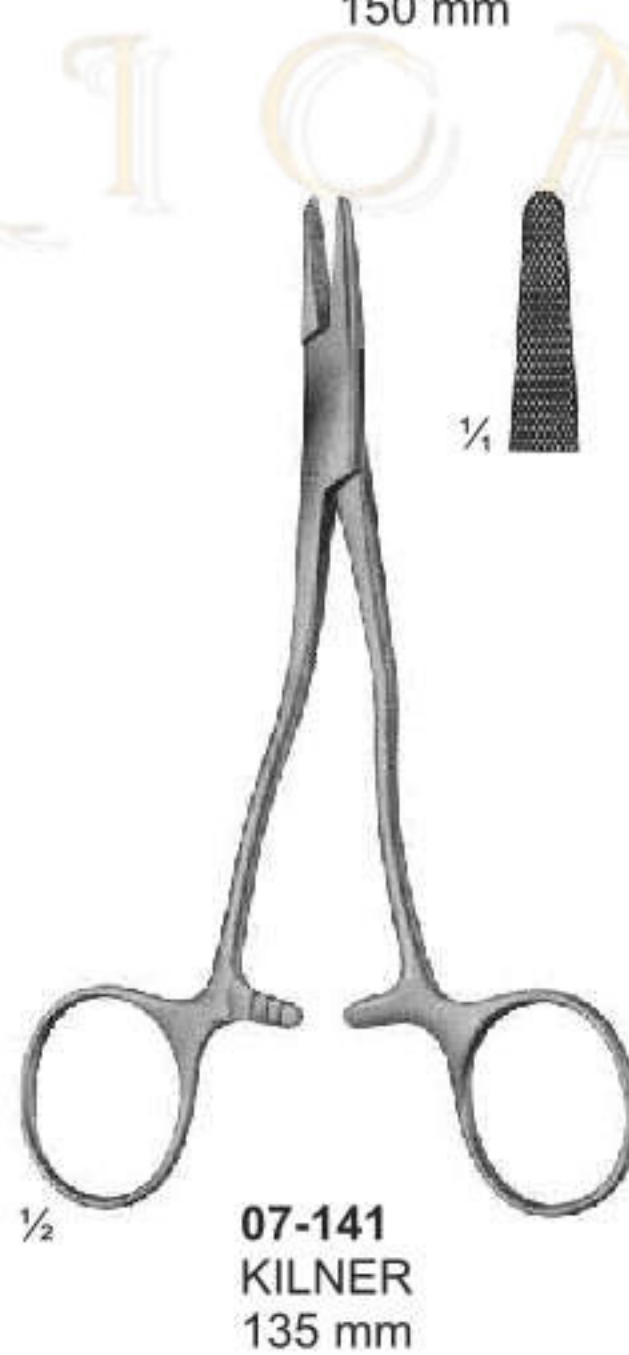
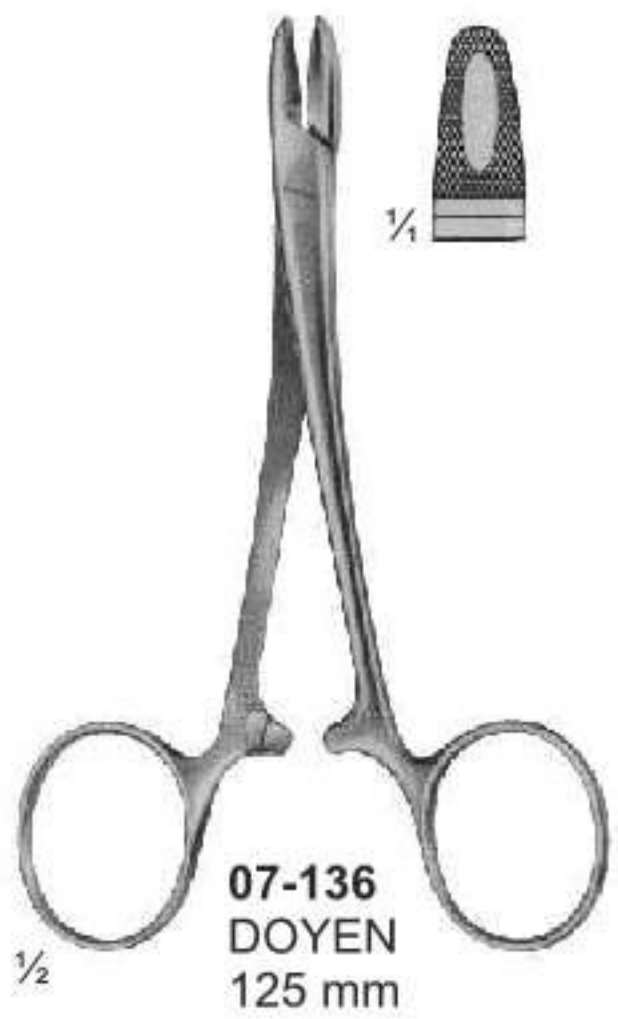
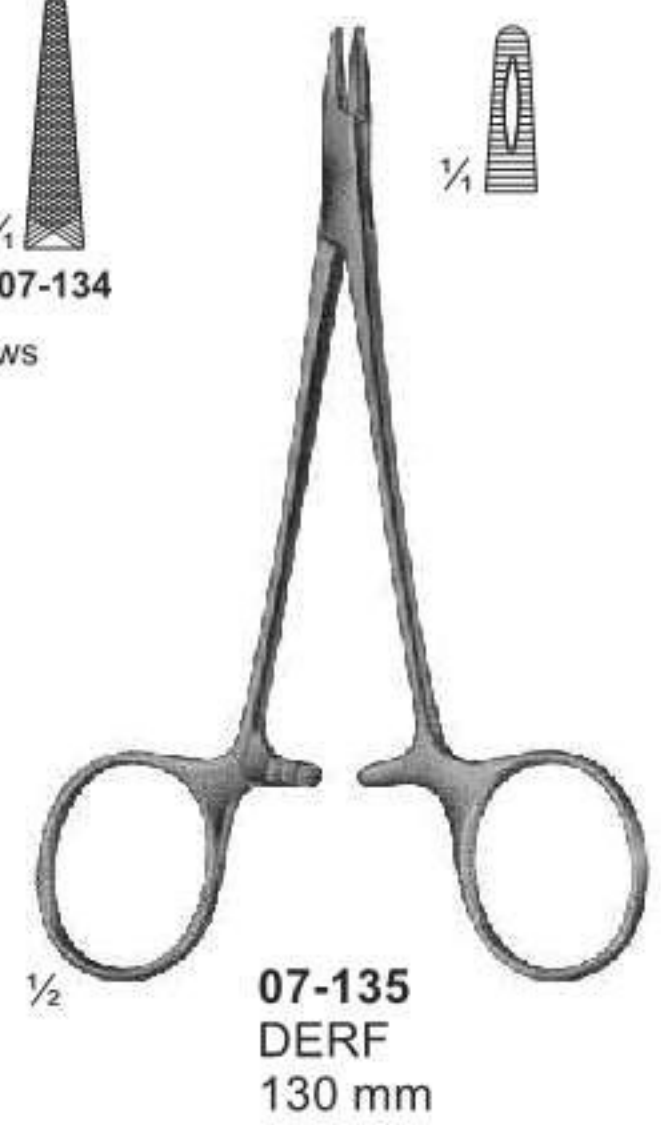
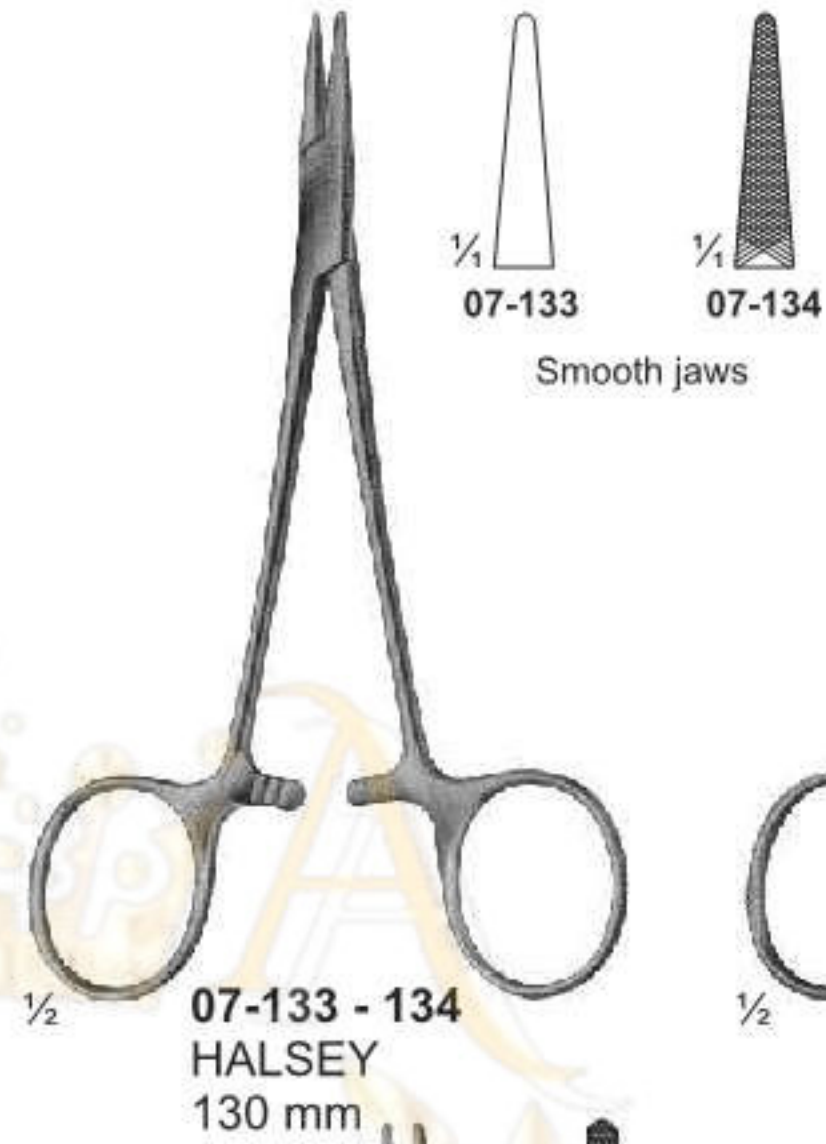

# Needle Holders



# Needle Holders

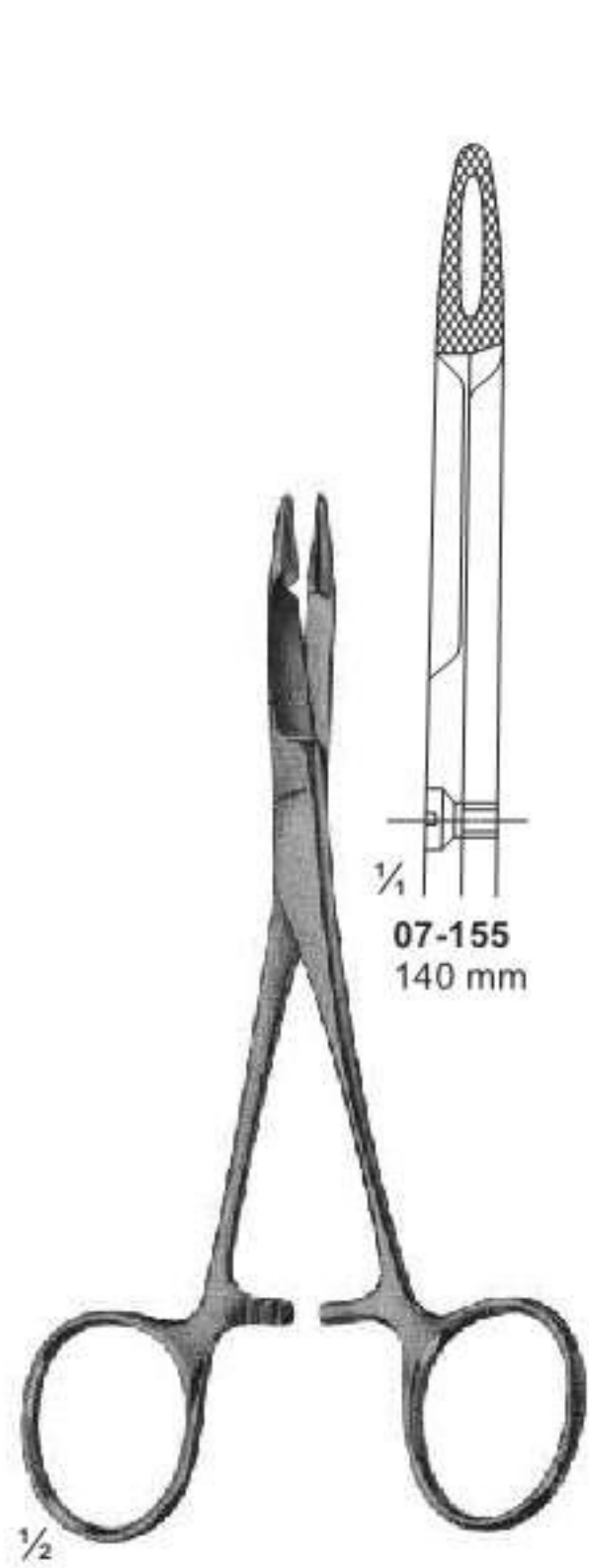

**07-155 - 156**  
HEGAR-OLSEN  
255 mm

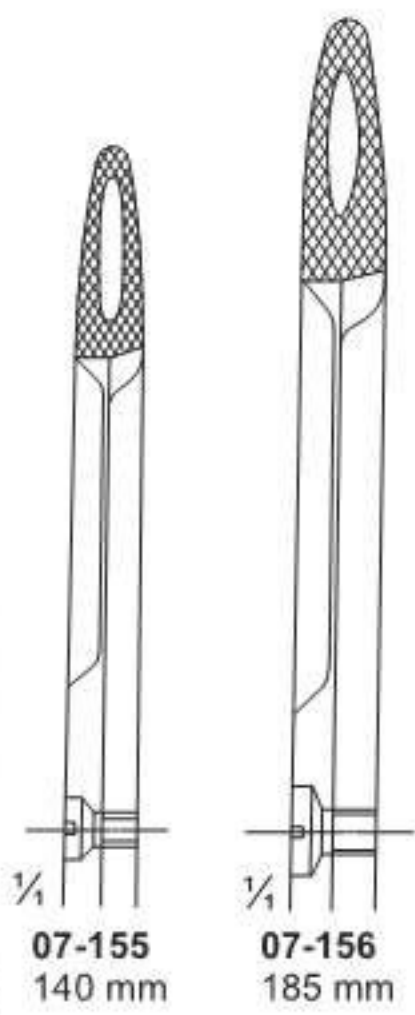

**07-155**  
140 mm

**07-156**  
185 mm

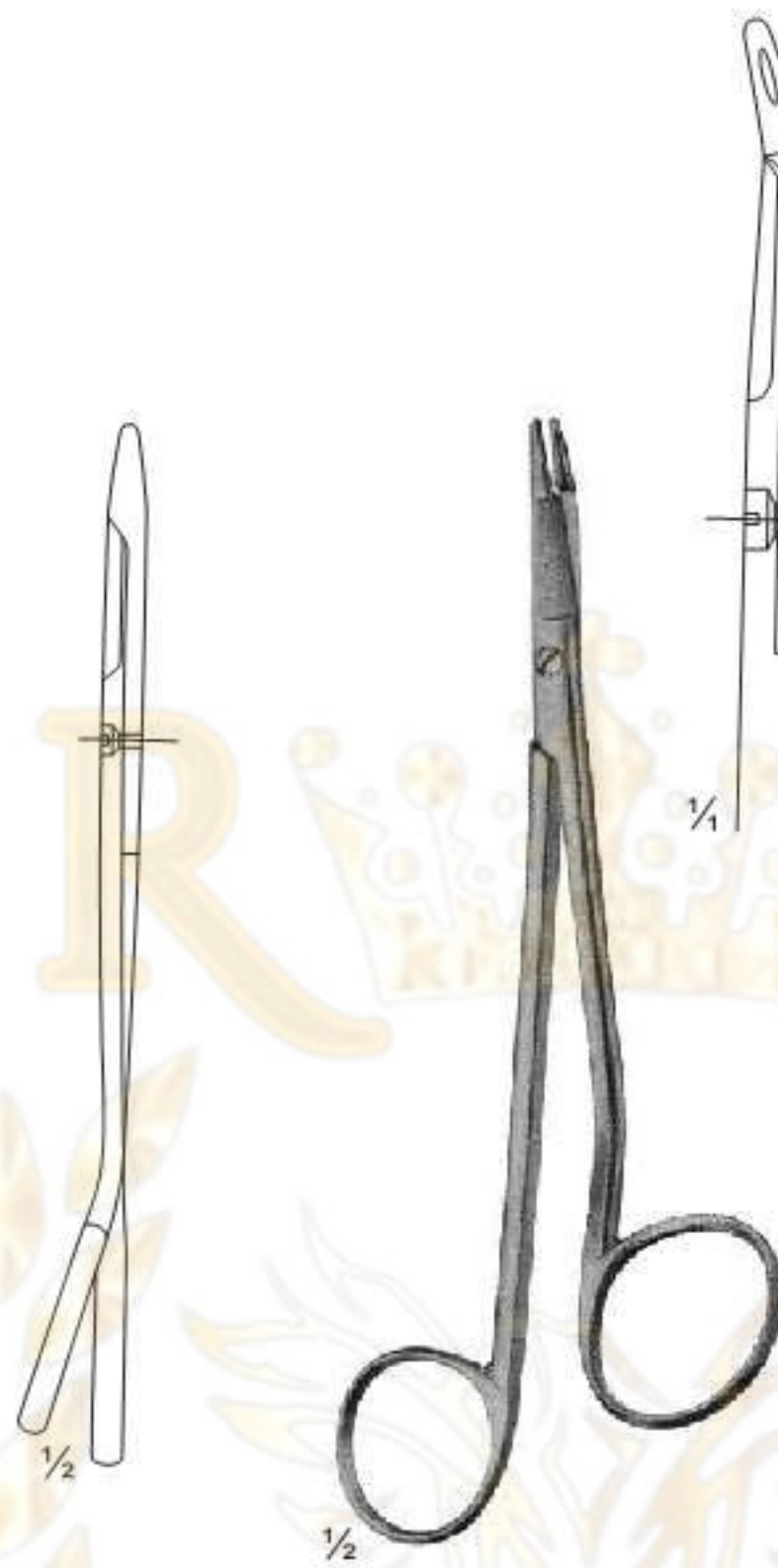

**07-157**  
GILLIES  
150 mm



1/4

1/2

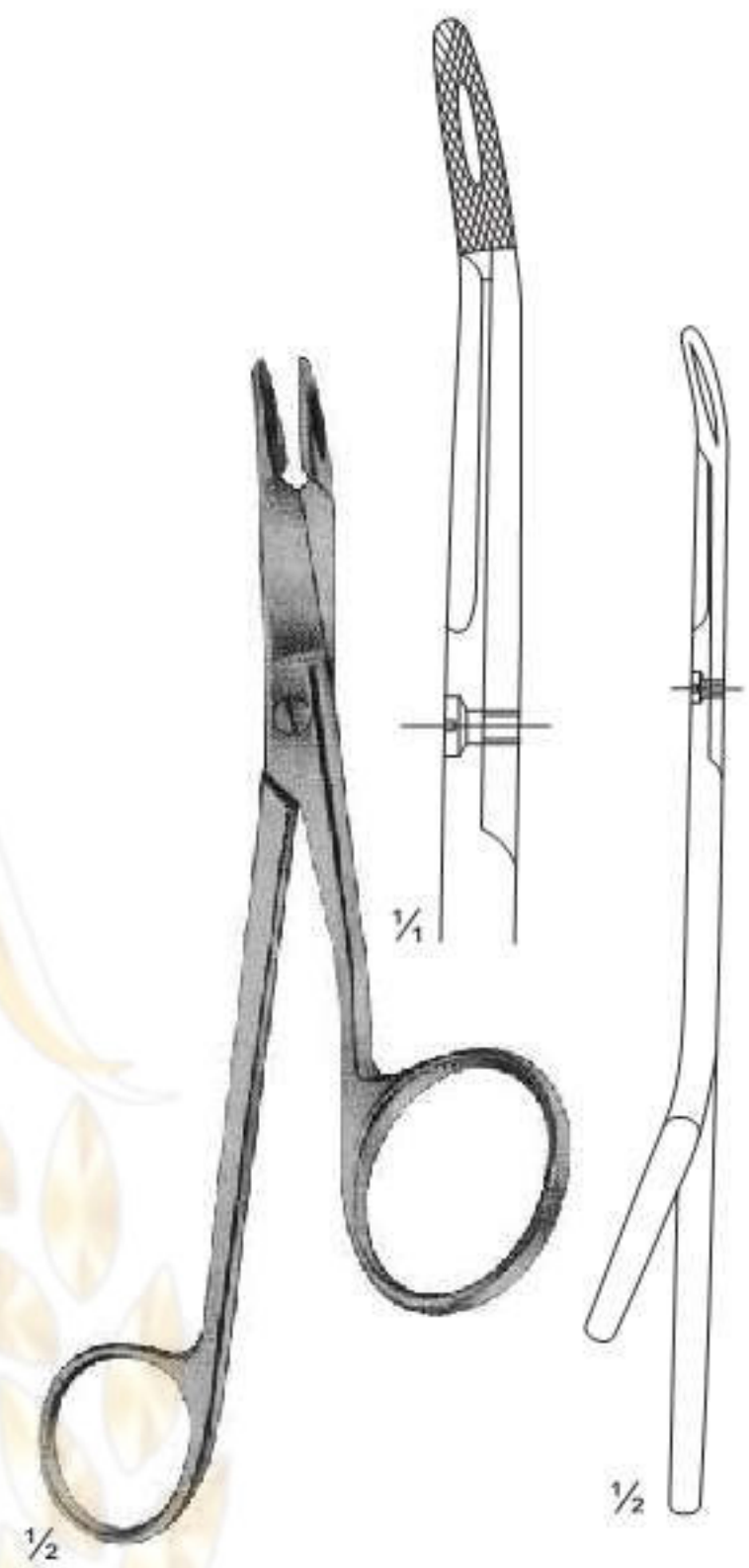

**07-158**  
GILLIES  
160 mm

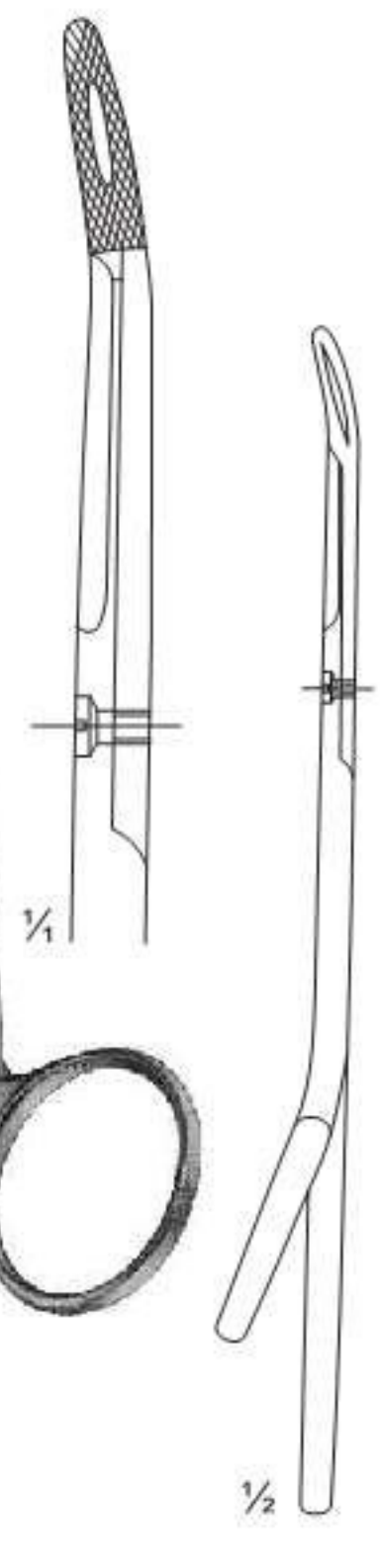

1/4

1/2

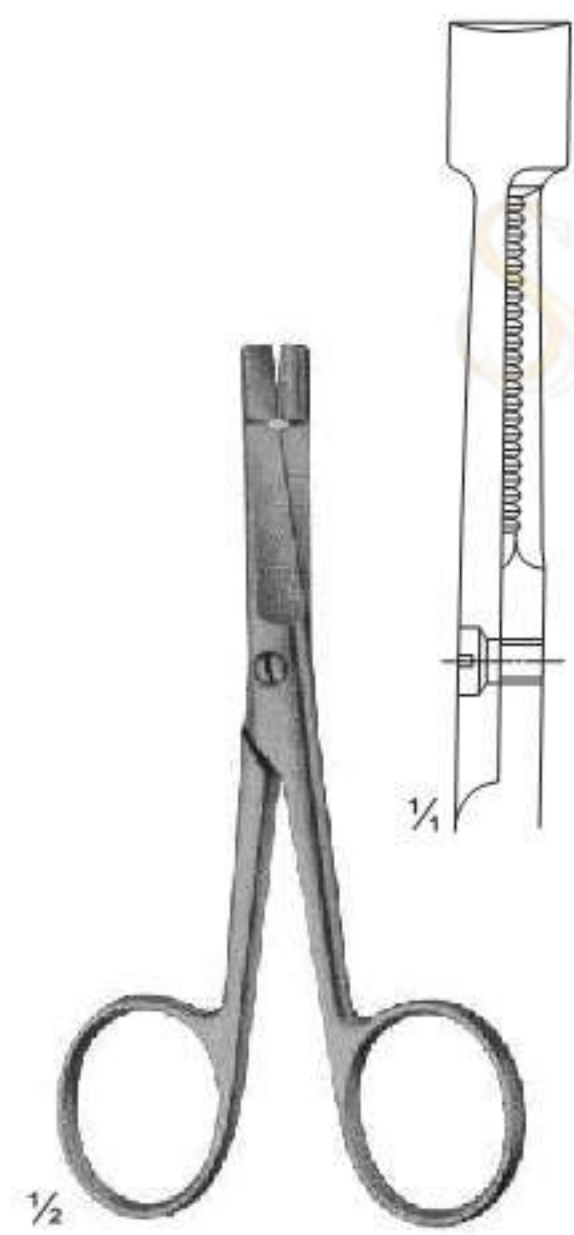

**07-159**  
EISELSBERG  
115 mm



1/4

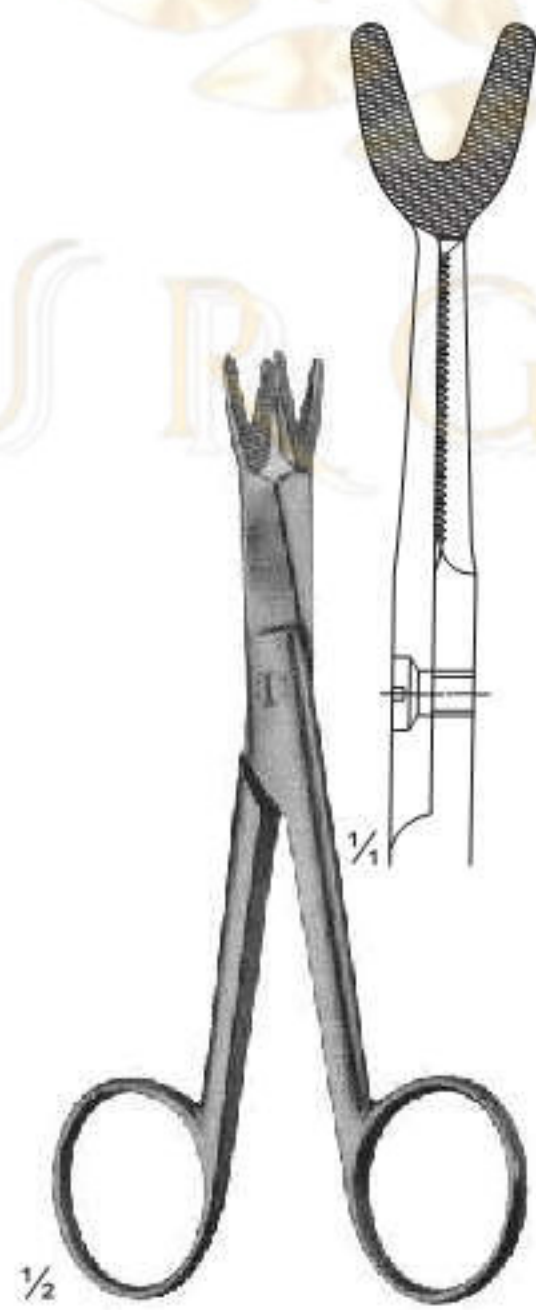

**07-160**  
SCHOEMAKER-LOTH  
125 mm



1/4



**07-161**  
CRILE  
150 mm



1/4



**07-162**  
TONNIS  
Elastic pattern for  
dura-or intestinal suture  
180 mm



1/4

# Needle Holders

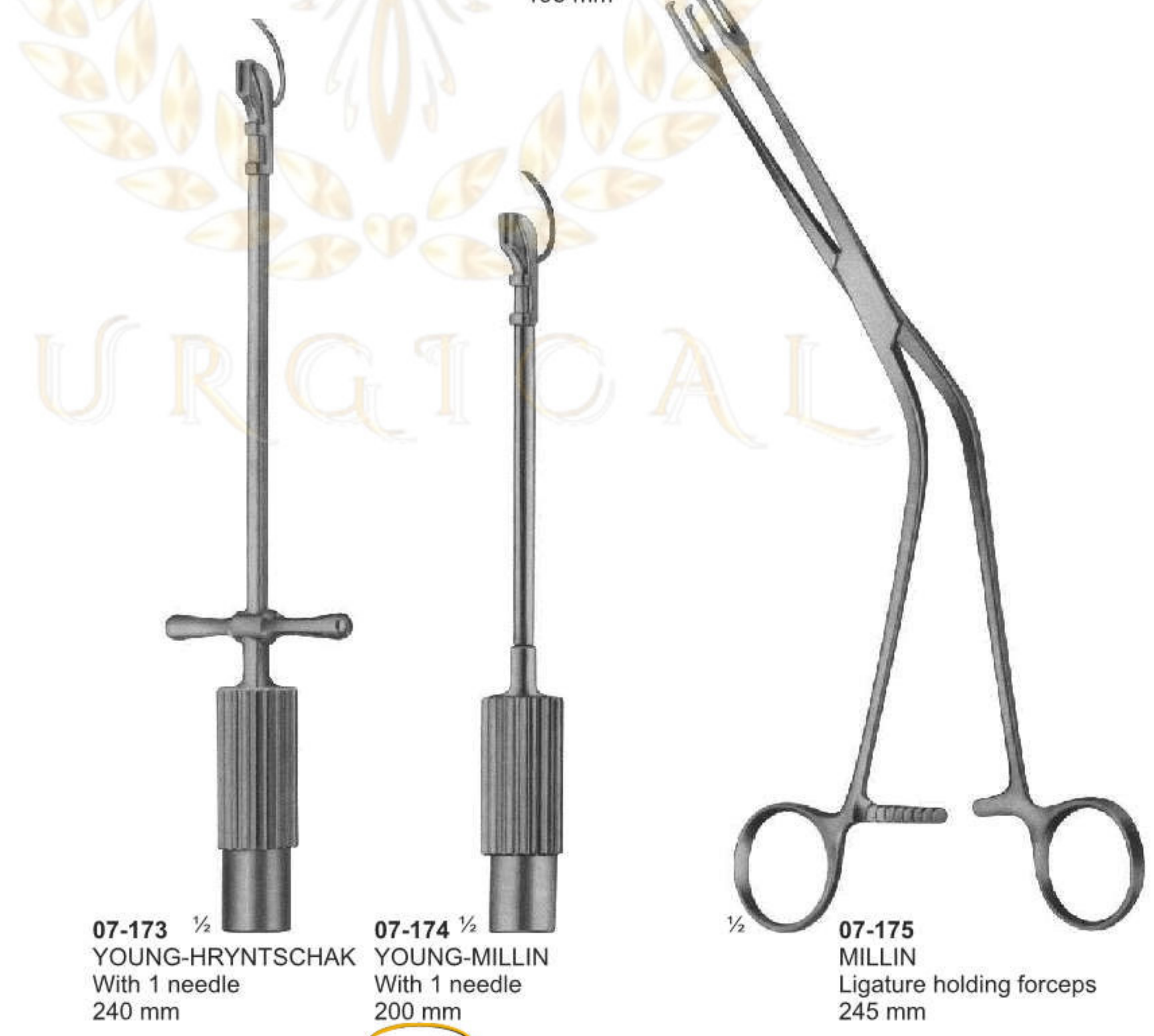
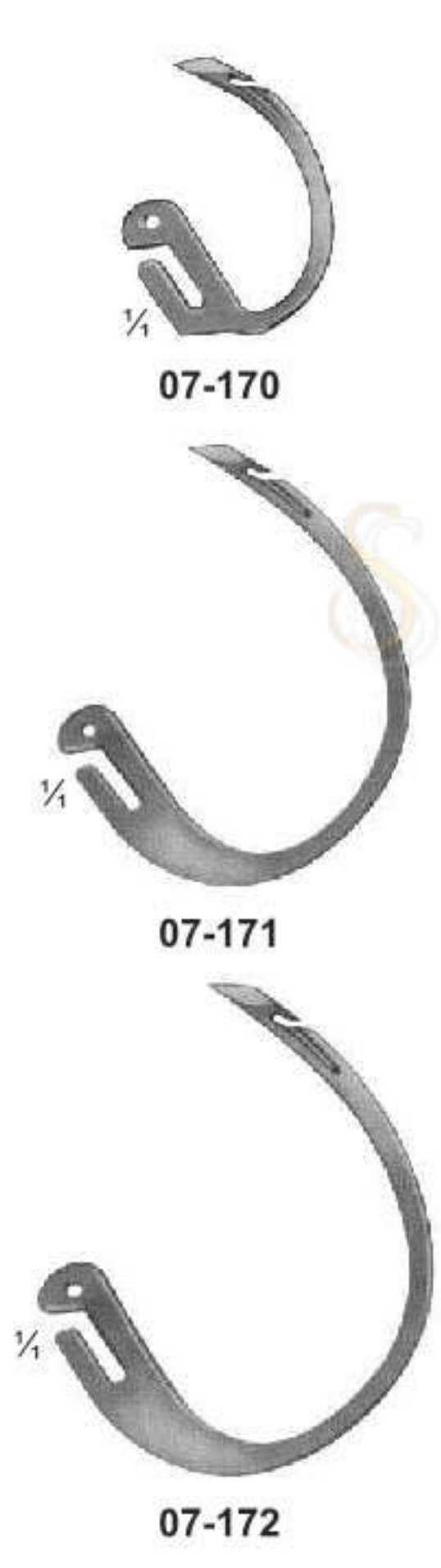
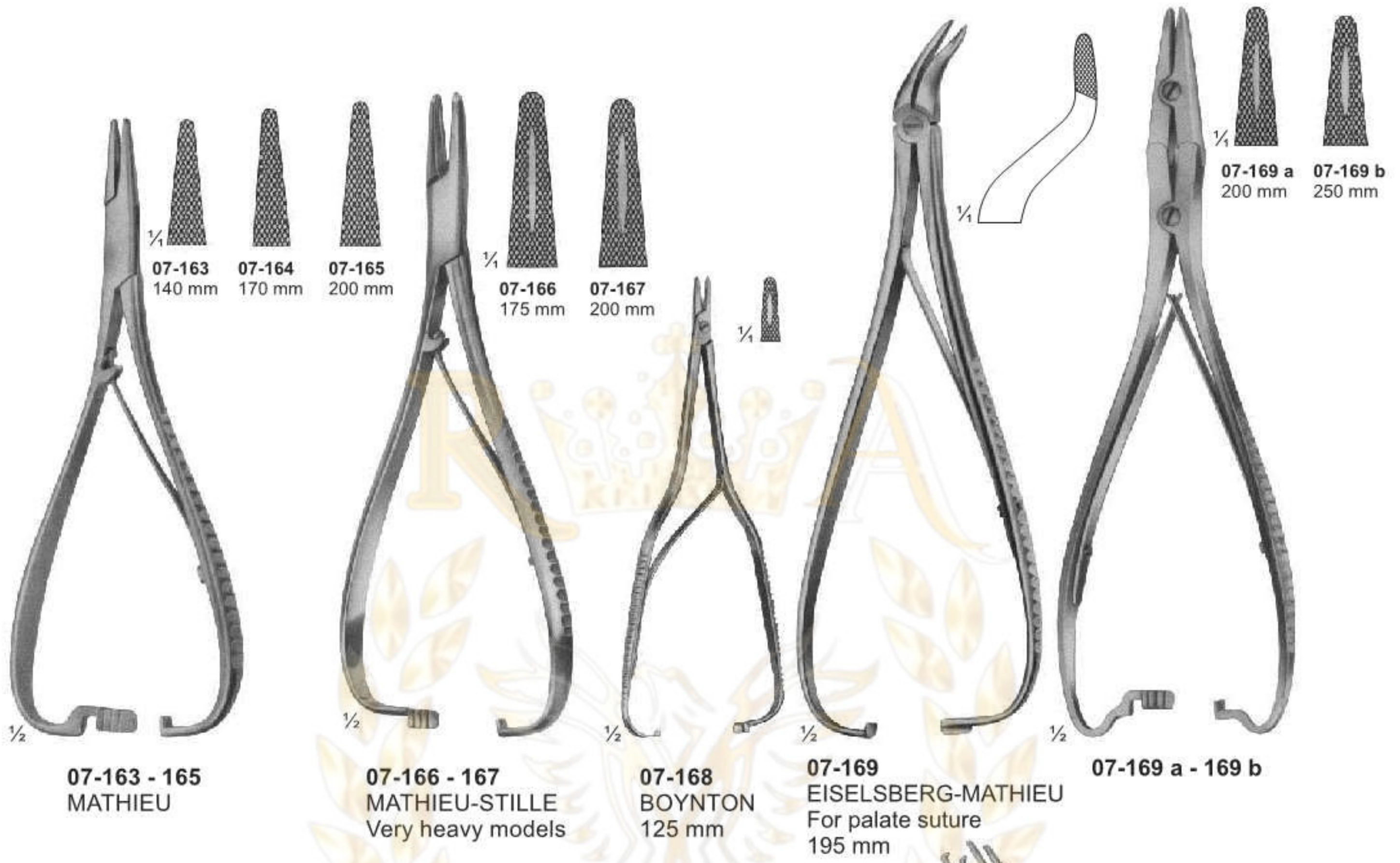

# Suture Instruments - Reverdin Needles

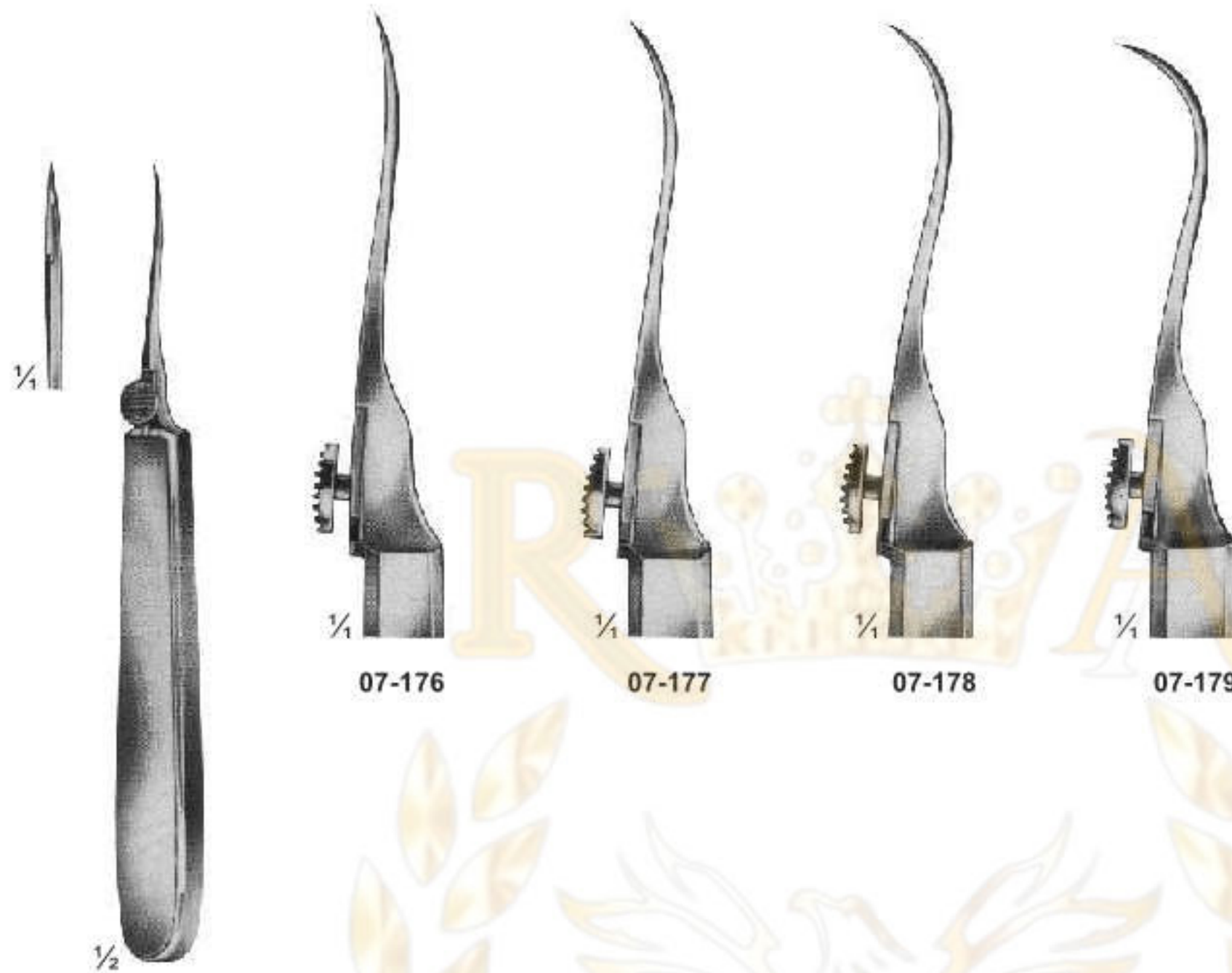

07-176

07-177

07-178

07-179

07-176 - 179  
REVERDIN  
140 mm



07-180

07-181

07-182

07-183

07-184

07-185

07-186

07-187

07-188

07-180 - 183  
REVERDIN  
195 mm

07-184 - 188  
REVERDIN  
220 mm

# Suture Instruments - Ligature Needles



# Suture Instruments - Ligature Needles



**07-201**  
HURD  
for right hand  
sharp  
210 mm

**07-202**  
HURD  
for left hand  
sharp  
210 mm

**07-203**  
DESCHAMPS  
for right hand  
sharp  
215 mm

**07-204**  
DESCHAMPS  
for left hand  
sharp  
215 mm

**07-205**  
JONESCO  
Needle for wire suture  
185 mm

**07-206**  
CLAUS VAN EICKEN  
Needle for wire suture  
250 mm

**07-207**  
150 mm

**07-208**  
SYME  
170 mm

**07-209**  
COOPER  
205 mm

**07-210**  
KOCHER  
205 mm



# Ligature Needles



**07-211**  
BRUNNER  
240 mm

**07-212**  
SCHMIEDEN-DICK  
320 mm

**07-213 - 216**  
BRUNNER  
Guiding Probes  
300 mm



# Probes



07-242 145 mm  
07-243 160 mm  
07-244 200 mm  
Probes with eye



07-245  
Myrtle leaf probe  
145 mm



07-246 130 mm  
07-247 145 mm  
07-248 160 mm  
07-249 180 mm  
07-250 200 mm



07-251  
Probes



07-252  
Double ended probe,  
malleable, diam. of tips  
3 mm with hole  
190 mm



07-253  
Double ended probes,  
tin, malleable,  
diam. of tips  
3,5 mm with hole  
250 mm, 300 mm



07-254  
Double ended probes,  
tin, malleable,  
diam. of tips 4 mm  
400 mm



07-255 1,5 mm  
07-256 2,0 mm  
07-257 2,5 mm  
300 mm

# Probes



07-242 2,5 mm  
07-243 2,5 mm  
07-244 3,0 mm

1/2

07-242 145 mm  
07-243 160 mm  
07-244 200 mm  
Probes with eye



1,5 mm

1/2

07-245  
Myrtle leaf probe  
145 mm



2,0 mm

1/2

07-246 130 mm  
07-247 145 mm  
07-248 160 mm  
07-249 180 mm  
07-250 200 mm



1/2

07-251  
Probes



1/2

07-252  
Double ended probe,  
malleable, diam. of tips  
3 mm with hole  
190 mm



07-253  
Double ended probes,  
tin, malleable,  
diam. of tips  
3,5 mm with hole  
250 mm, 300 mm



1/4

07-254  
Double ended probes,  
tin, malleable,  
diam. of tips 4 mm  
400 mm



1/3

07-255 1,5 mm  
07-256 2,0 mm  
07-257 2,5 mm  
300 mm

# Probes - Spatulas - Cotton Applicators



**07-258**  
STACKE  
100 mm



**07-259**  
KILLIAN  
165 mm



**07-260**  
160 mm



**07-261**  
SEIFFERT  
180 mm



**07-262**  
BOWMAN  
130 mm

German Silver



**07-263**  
SPATULA  
145 mm



**07-264**  
SPATULA  
145 mm



**07-265**  
Modell PICCOLO  
Round Serrated  
110 mm



**07-266**  
Modell PICCOLO  
Triangular Serrated end  
110 mm



**07-267**  
FARRELL  
Round Serrated end  
110 mm



**07-268**  
LATHBURY-FARREL  
Triangular Serrated end  
110 mm

# Cotton Applicators



**07-269**  
BUCK  
Rough, spiral end  
120 mm

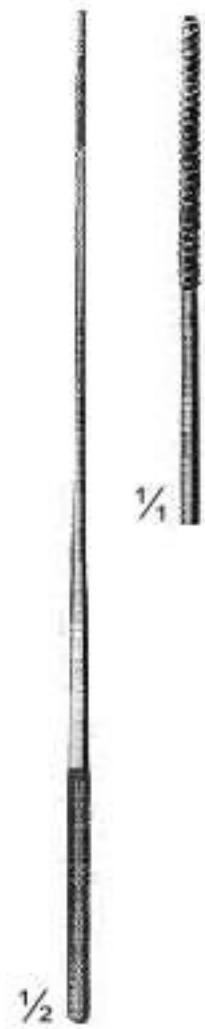

**07-270**  
Triangular  
serrated end  
140 mm



**07-271**  
Rough, spiral end  
140 mm



**07-272**  
Rough, spiral end  
140 mm



**07-273**  
Rough, spiral end  
140 mm



**07-274**  
FARRELL  
Round,  
serrated end  
140 mm



**07-275**  
LATHBURY-FARRELL  
Triangular,  
serrated end  
140 mm



**07-276**  
FARRELL  
Rough,  
spiral end  
160 mm



**07-277**  
LATHBURY-FARRELL  
Triangular,  
serrated end  
160 mm



**07-278**  
Triangular,  
serrated end  
160 mm

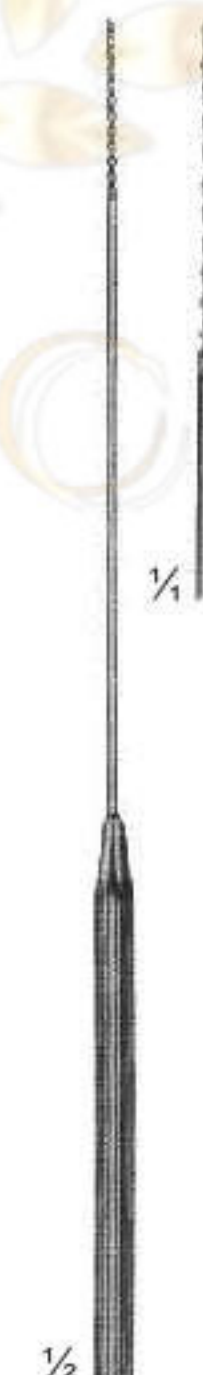

**07-279**  
Rough,  
spiral end  
180 mm



**07-280**  
Rough,  
spiral end  
180 mm



**07-281**  
Rough,  
spiral end  
270 mm

# Clip Applying Forceps - Suture Set



**07-282**  
MICHEL  
125 mm



**07-283**  
HEGENBARTH  
120 mm



**07-284**  
WACHENFELDT  
120 mm



**07-285**  
WACHENFELDT  
120 mm



**07-286**  
MICHEL  
125 mm



**07-287**  
MICHEL modif.  
130 mm



**07-288**  
HEATH  
135 mm

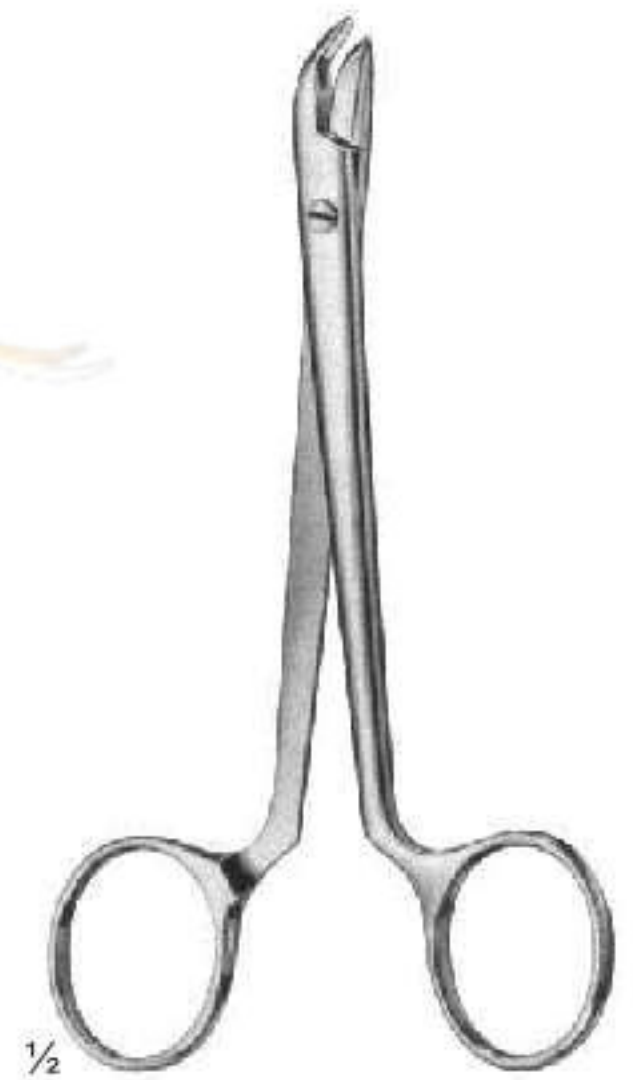

**07-289**  
COLLIN  
135 mm

# Clip Applying Forceps - Suture Set



## 07-290

Suturing instruments set, in metal case consisting of:

- Scissors, curved, sharp/sharp, 115mm
- 25 MICHEL clip, 16 x 3mm
- 1 Delicate tissue forceps, 130mm
- 1 Scalpel, bellied
- 1 MATHIEU needle holder, 140mm
- 1 Perforated metal case, stainless containing:
- 1 Suture needle
- 1 item 1 item

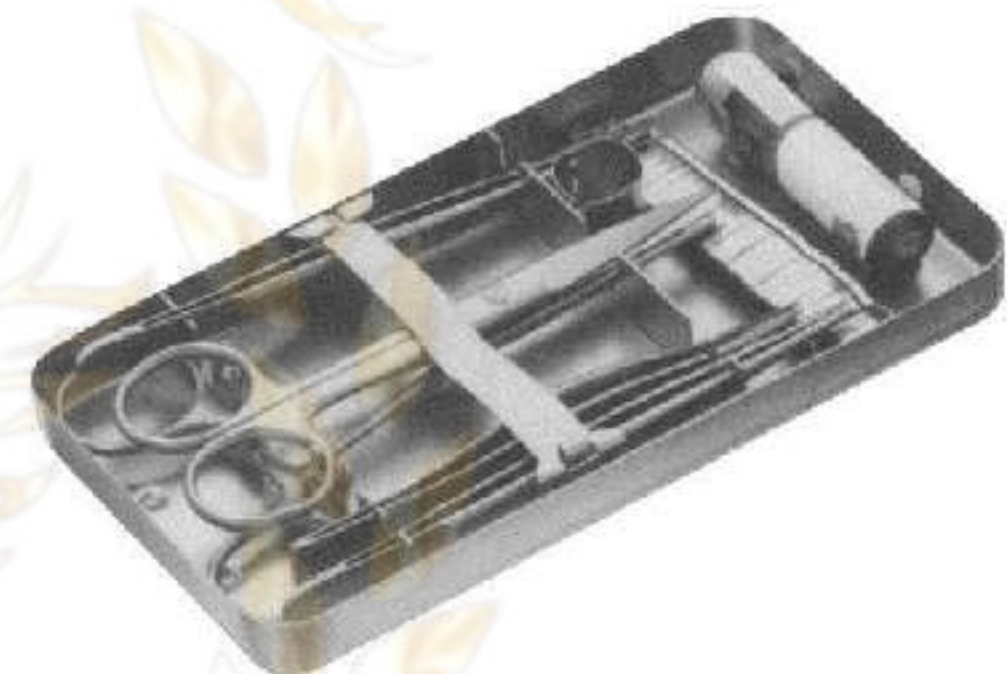

## 07-291

Pocket instrument set, in metal case consisting of:

### Bottom tray

- 1 MATHIEU needle holder, 140mm
- 1 MICHEL clip forceps, combined
- 1 Myrtle leaf probe, 130mm
- 1 Sharp double curette
- 1 Skin hook
- 1 Detachable scalpel handle, no.4
- 1 Perforated metal case, containing
- 6 Scalpel blades BB 520
- 1 Perforated metal case, stainless, containing
- 1 Suture needle
- 1 item
- 1 item

### Top tray

- 1 Tissue forceps, 130mm
- 1 KOCHER haemostatic forceps, 130mm
- 1 Straight surgical scissors, 130mm
- 1 Dissecting forceps, 130mm
- 1 FEILCHENFELD splinter forceps, 115mm
- 25 MICHEL clip, 16 x 3mm
- 1 Flacon of suture skin, sterile in alcohol

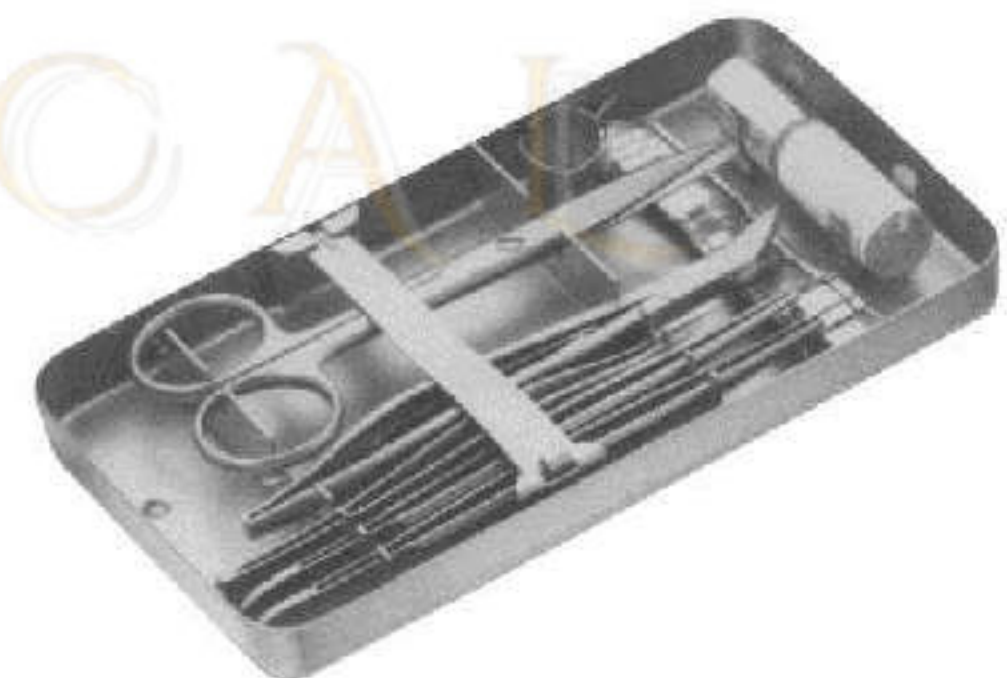
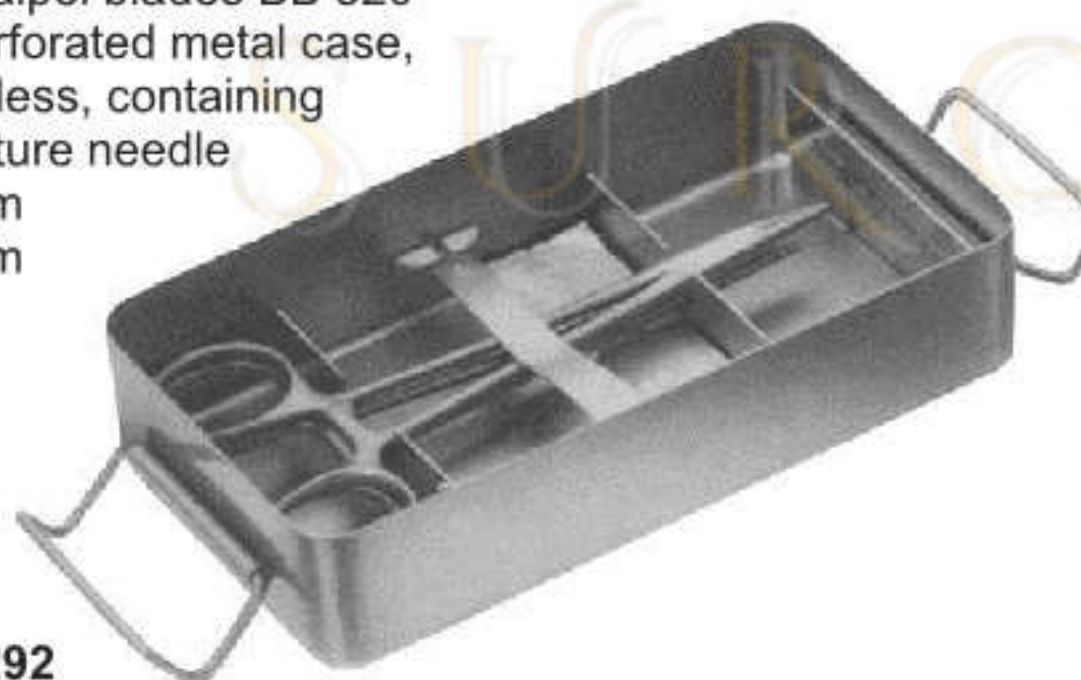

## 07-292

Pocket instrument set, in metal case consisting of:

### Bottom tray

- 1 MAYO-HEGER needle holder, 150mm
- 1 MICHEL clip forceps, combined
- 1 Myrtle leaf probe, 130mm
- 1 Sharp double curette
- 1 Skin hook
- 1 Detachable scalpel handle, no. 4
- 1 Perforated metal case, consisting
- 6 Scalpel blades BB 520
- 1 Perforated metal case, stainless, consisting:
- 1 Suture needle
- 1 item, & 1 item

### Bottom tray

- 1 Tissue forceps, 130mm
- 1 CRILE haemostatic forceps, 140mm
- 1 Straight surgical scissors, 130mm
- 1 Dissecting forceps, 130mm
- 1 FEILCHENFELD splinter forceps, 115mm
- 25 MICHEL clip, 16 x 3mm
- 1 Flacon of suture silk, sterile in alcohol



## Clip Applying Forceps - Suture Set



### 07-293

Pocket instrument set in metal case 170 x 90mm with sterilizable canvas roll consisting of:

- 1 Myrtle leaf probe, 130mm
- 1 Sharp double curette
- 1 FEILCHENFELD splinter forceps, 115mm
- 1 Dissecting forceps, 130mm
- 1 Tissue forceps, 130mm

- 1 Straight surgical scissors, 130mm
- 1 Scalpel handle no. 4
- 1 Perforated metal case, consisting 6 scalpel blades BB 520
- 1 KOCHER haemostatic forceps, 130mm
- 1 Skin hook
- 1 MATHIEU needle holder, 140mm
- 1 Tube of suture skin, sterile in alcohol
- 1 MICHEL clip forceps, 120mm

- 25 MICHEL clip, 16 x 3mm
- 1 Perforated metal case, stainless, consisting:
- 1 Suture needle
- 1 item
- 1 item



### 07-294

Venae sectio set, in sterilizable canvas roll consisting of:

- 1 Tissue forceps, 1 x 2 teeth, 140mm
- 1 Dissecting forceps, 145mm
- 1 FEILCHENFELD straight scissors, sharp, 110mm
- 1 curved scissors, blunt, 115mm
- 1 HALSTED mosquito forceps, curved on flat, 125mm

- 1 DESCHAMPS needle, blunt, 210mm
- 1 DOYEN Director, curved, 140mm
- 2 Wound retractors, 4 blunt prongs, 160mm
- 2 DESMARRES wound retractors, 135mm
- 1 FINSEN retractors, 2 x3 blunt prongs, 80mm

- 1 Scalpel handle no. 4
- 4 Sterile scalpel blades, no 18, single peel pack
- 1 Needle box, perforated, round, diam. 65mm
- 1 HEGAR-MAYO DUROGRIP needle holder, 180mm



## Clip Applying Forceps - Suture Set

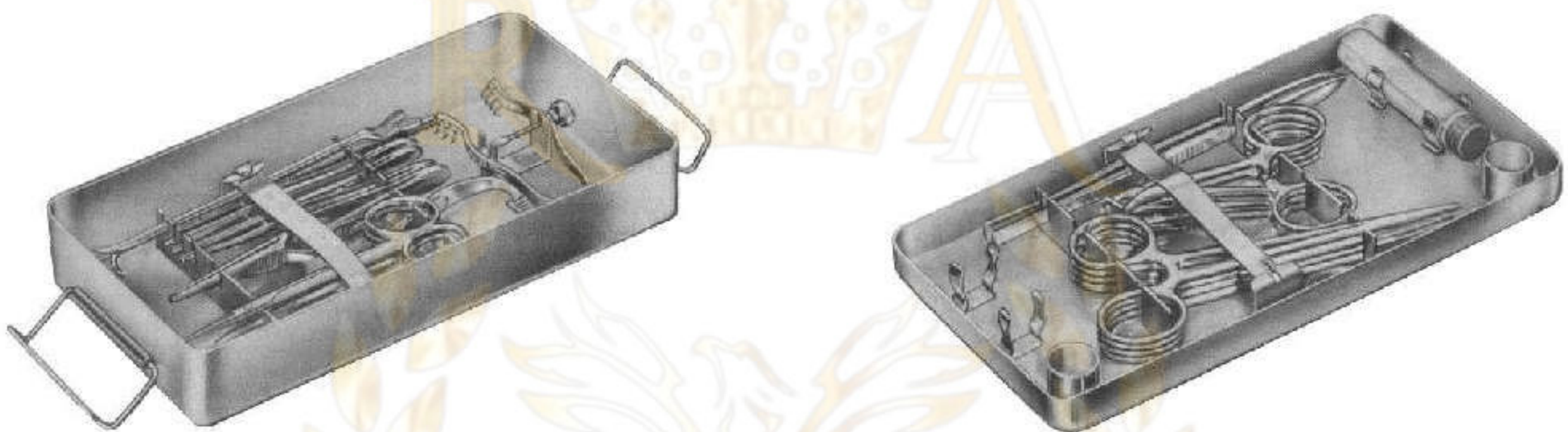

### 07-295

Venae sectio set, in metal case  
consisting of:

#### Bottom tray

- 1 MATHIEU needle holder, fine pattern 140mm
- 1 Ligature needle, fine short pattern
- 1 DOYEN director, curved
- 1 HEGENBARTH clip forceps,
- 1 ELSCHNIG tissue forceps, 1 x 2 teeth fine, 150mm
- 1 Dressing forceps, fine 105mm
- 1 Tissue forceps, 1 x 2 teeth, 110mm
- 1 Vessel scissors, straight, with 1 ball point, 110mm
- 1 Vessel scissors, curved, pointed 105mm
- 1 FINSSEN retractor
- 1 Perforated needle case

#### Top tray

- 1 Scalpel, pointed
- 1 Scalpel, bellied
- 2 HALSTED mosquito forceps, curved, 125mm
- 2 HALSTED mosquito forceps, straight, 1x 2 teeth, 125mm
- 3 BACKHAUS towel forceps, 90mm
- 2 Flacon holder

# Nerve - and Vessel Hooks

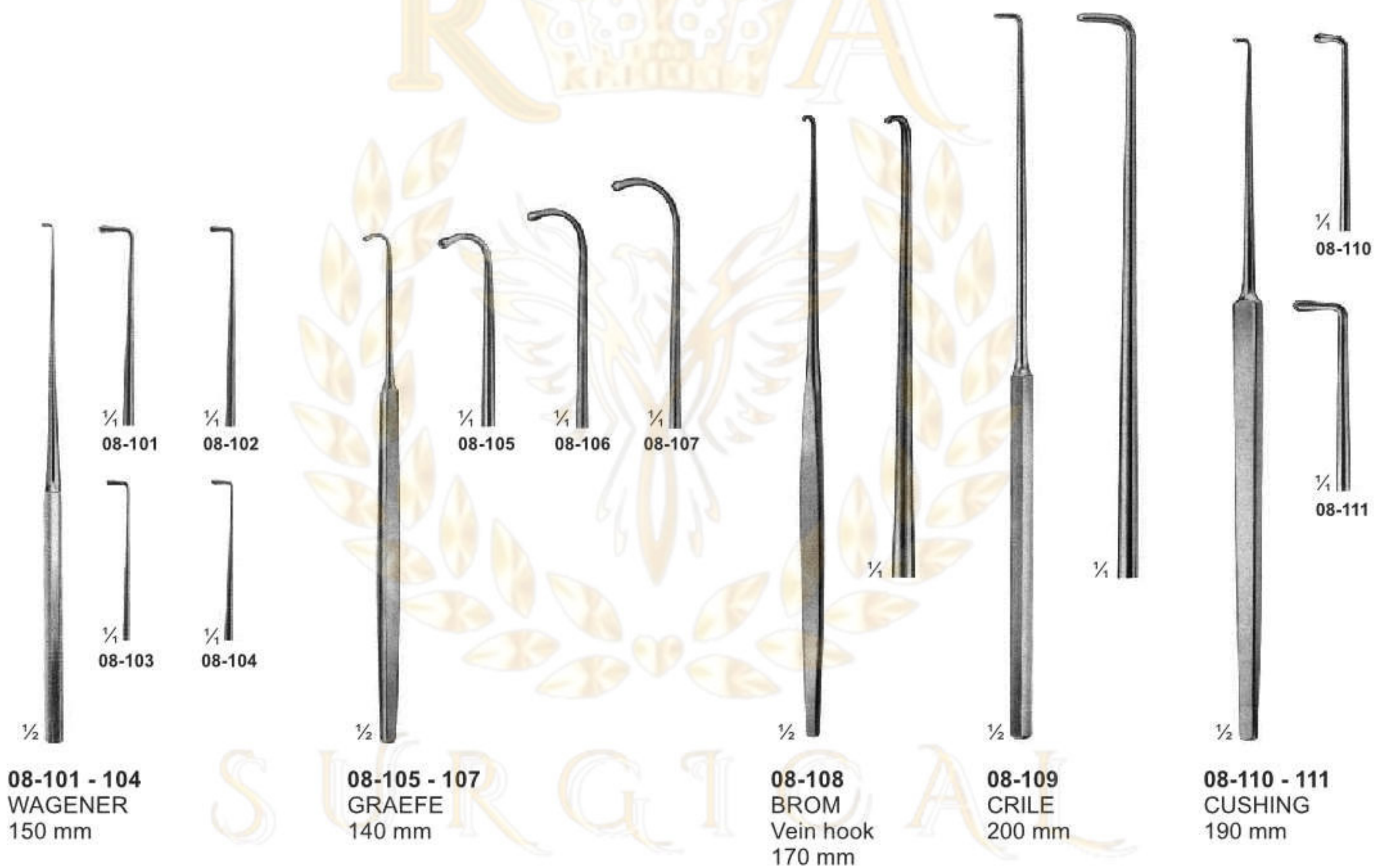

# Nerve - and Vessel Hooks



# Fine Wound Retractors (Dura- and Skin Retractors)

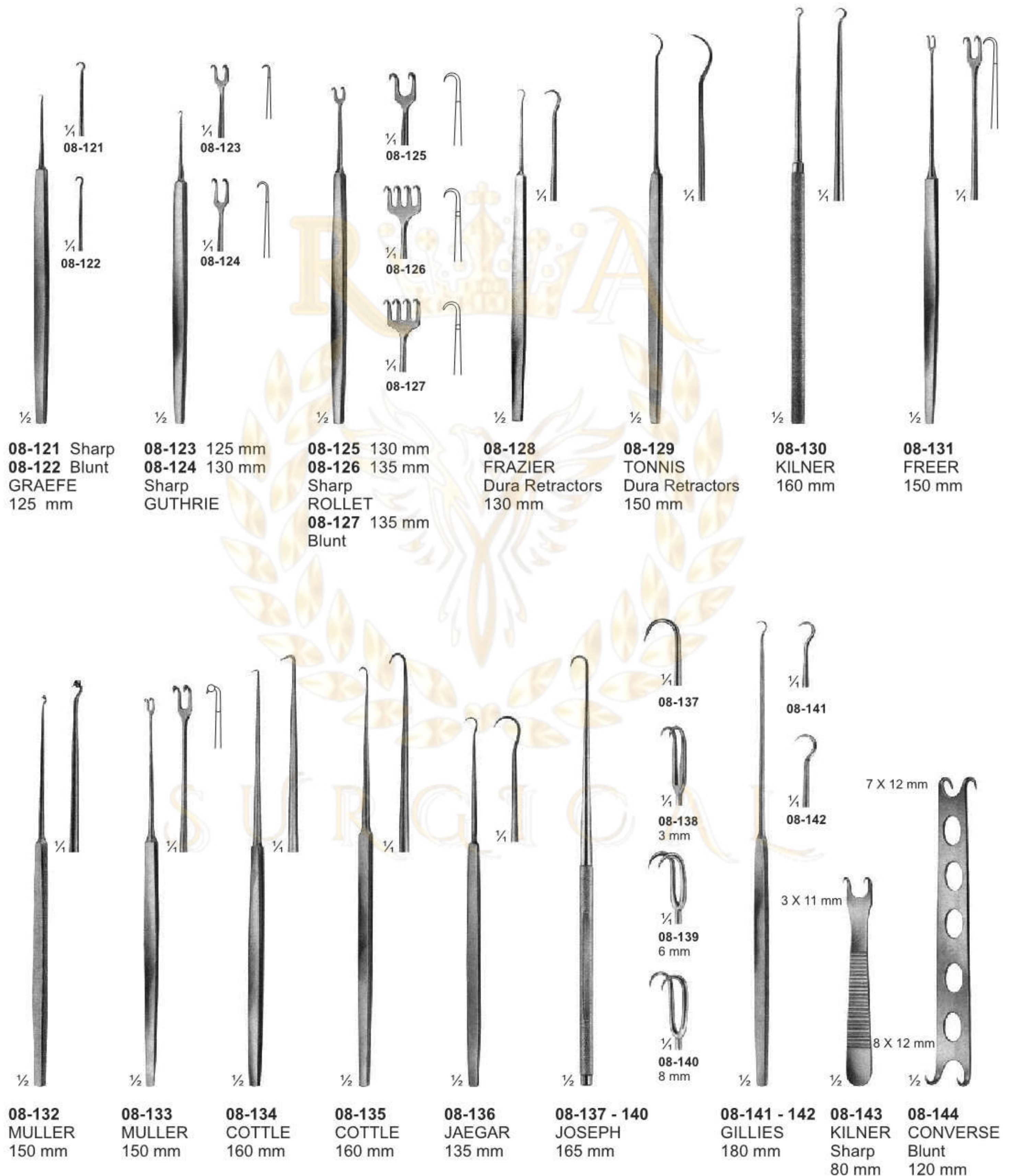

# Wound - Trachea Retractors

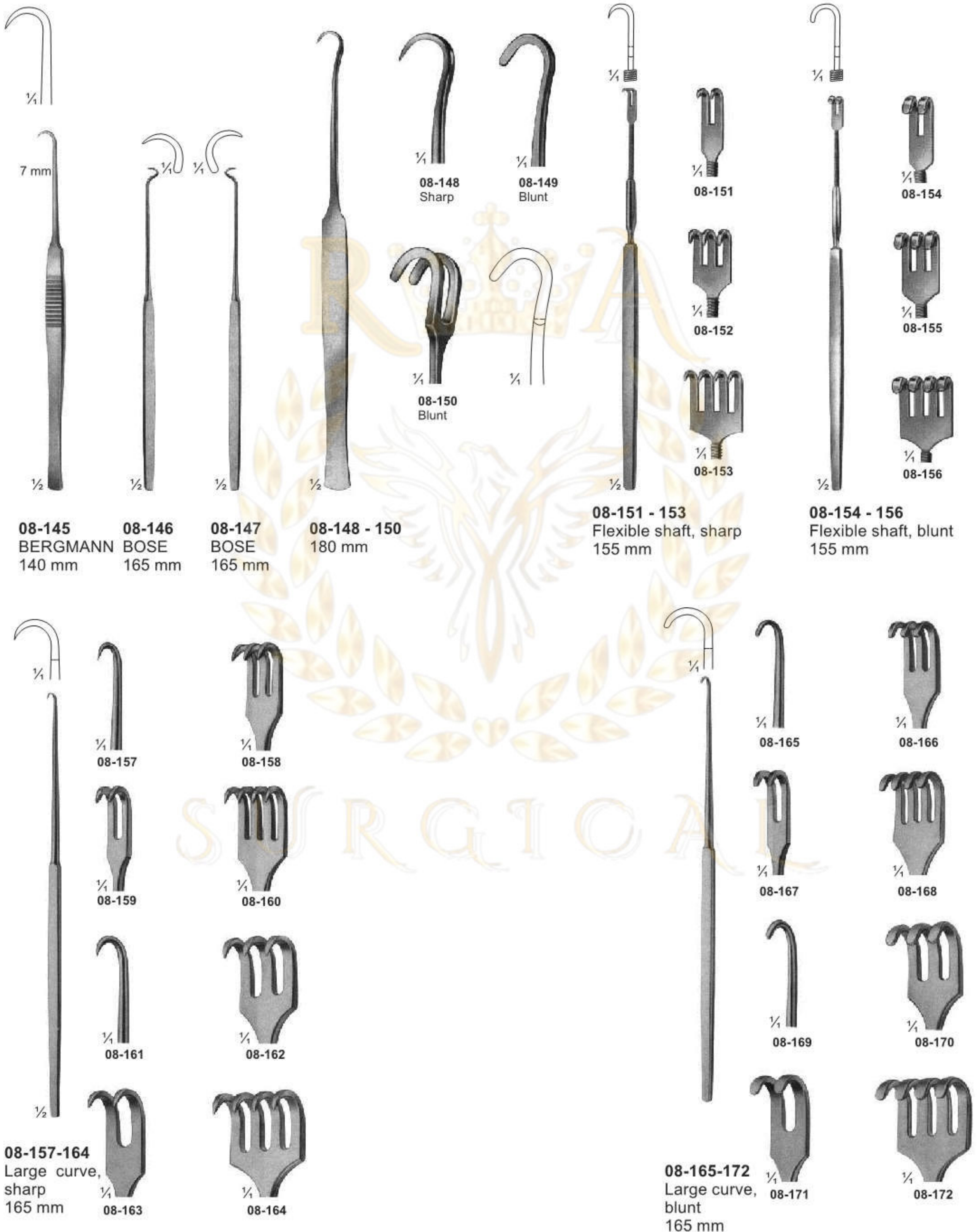

**08-145**  
BERGMANN  
140 mm

**08-146**  
BOSE  
165 mm

**08-147**  
BOSE  
165 mm

**08-148 - 150**  
180 mm

**08-151 - 153**  
Flexible shaft, sharp  
155 mm

**08-154 - 156**  
Flexible shaft, blunt  
155 mm

**08-157-164**  
Large curve, sharp  
165 mm

**08-165-172**  
Large curve, blunt  
165 mm

# Retractors With Treangle Handle

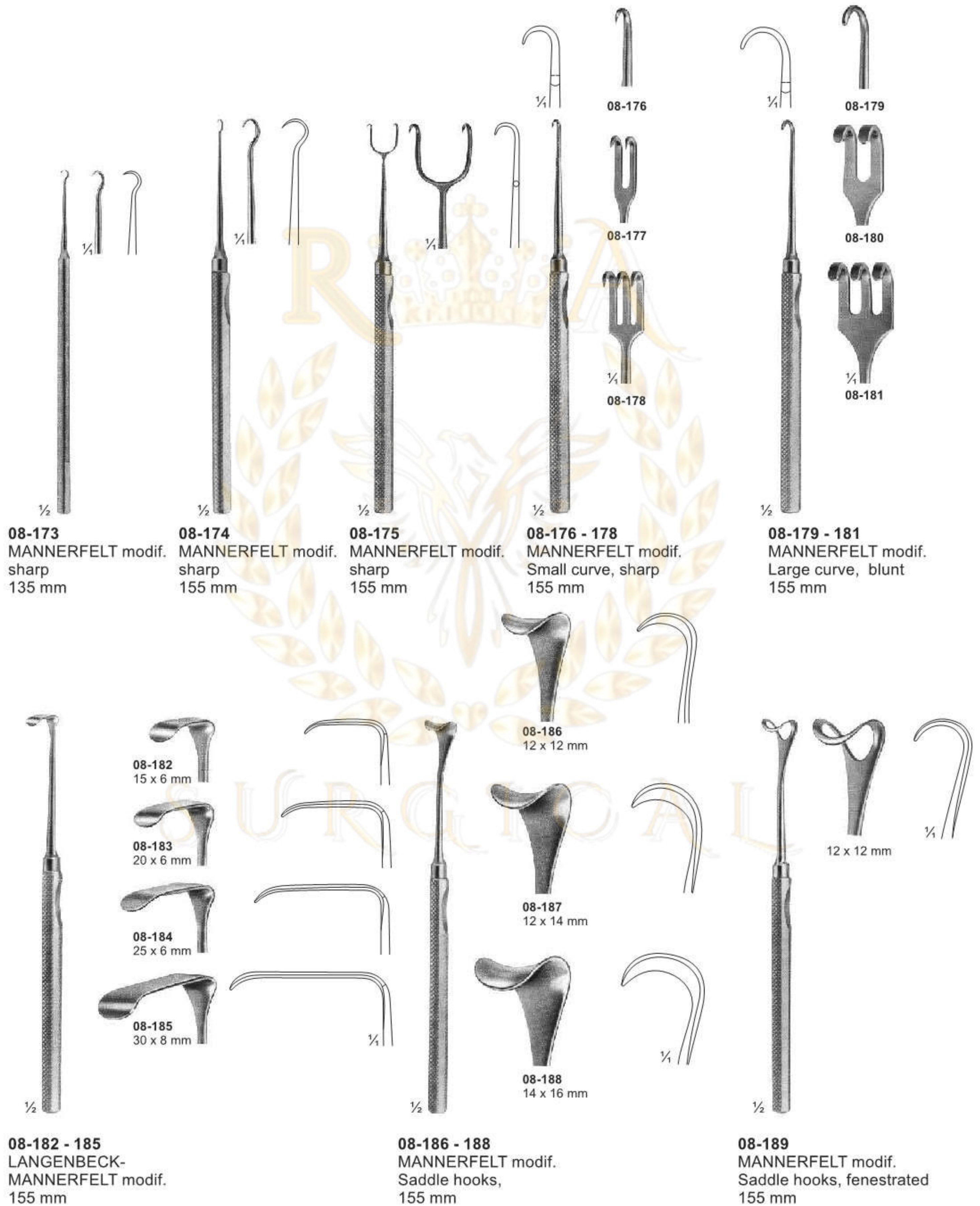

# Retractors

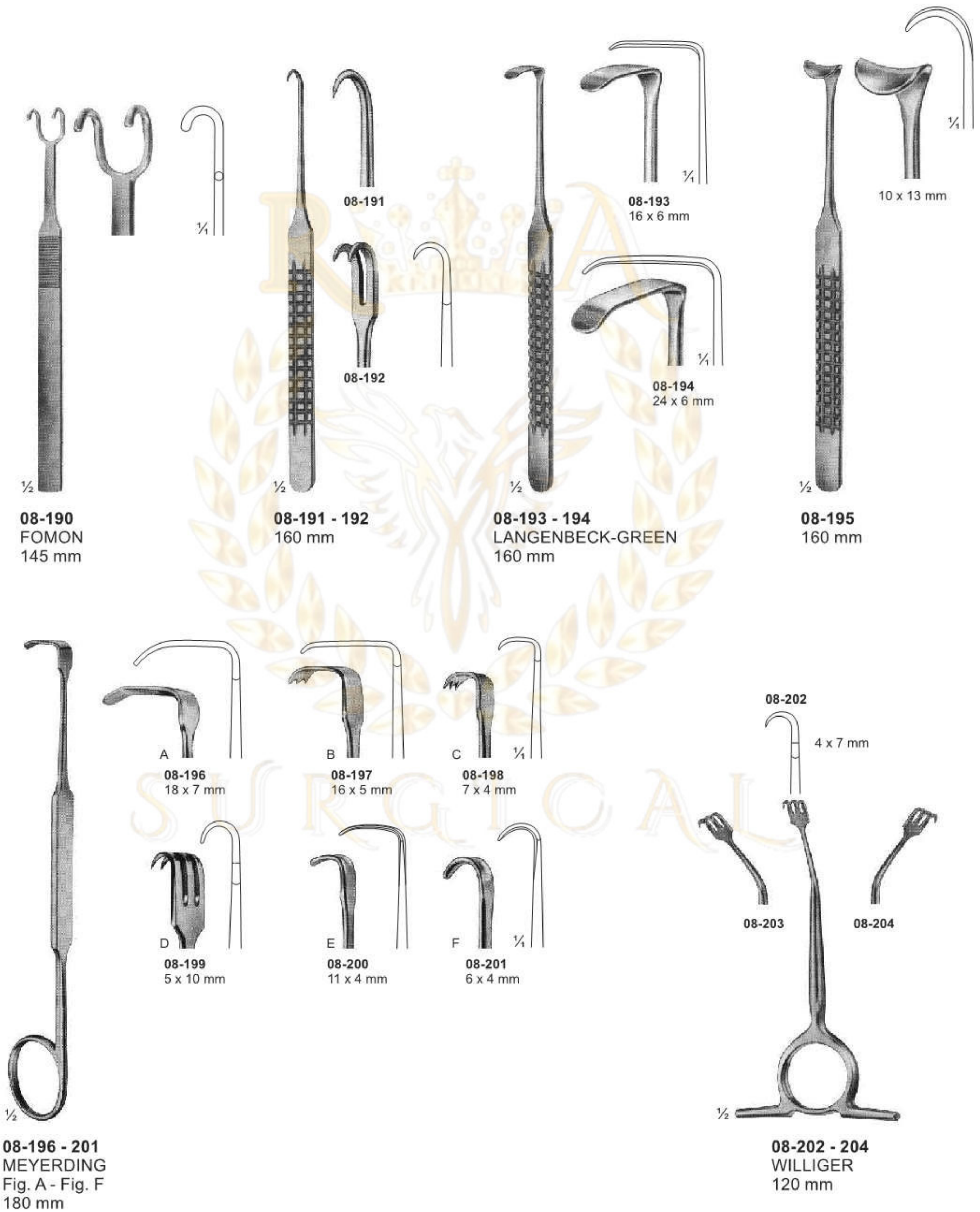



# Retractors

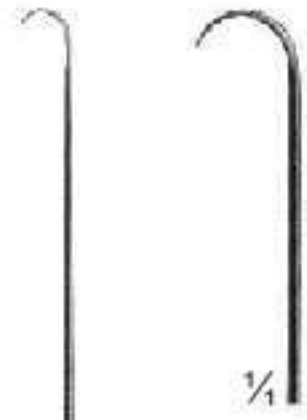

**08-205**  
EMMET  
Fistula hook  
220 mm

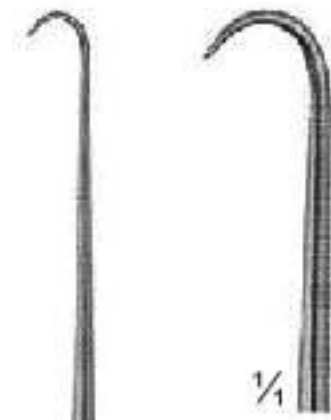

**08-206**  
SIMON  
Fistula hook  
220 mm

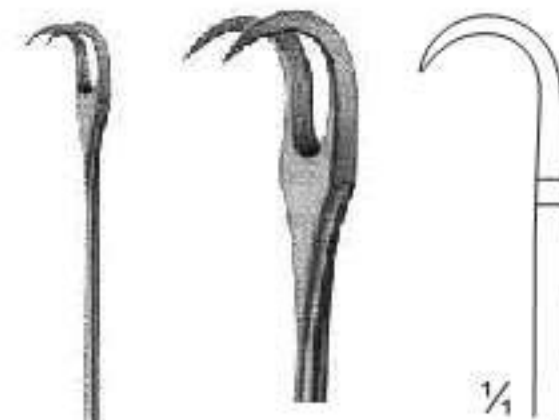

**08-207**  
SIMON  
Fistula hook  
220 mm



**08-208**  
LANGE  
Fistula hook  
230 mm



**08-209 - 210**  
Tendon hooks  
175 mm

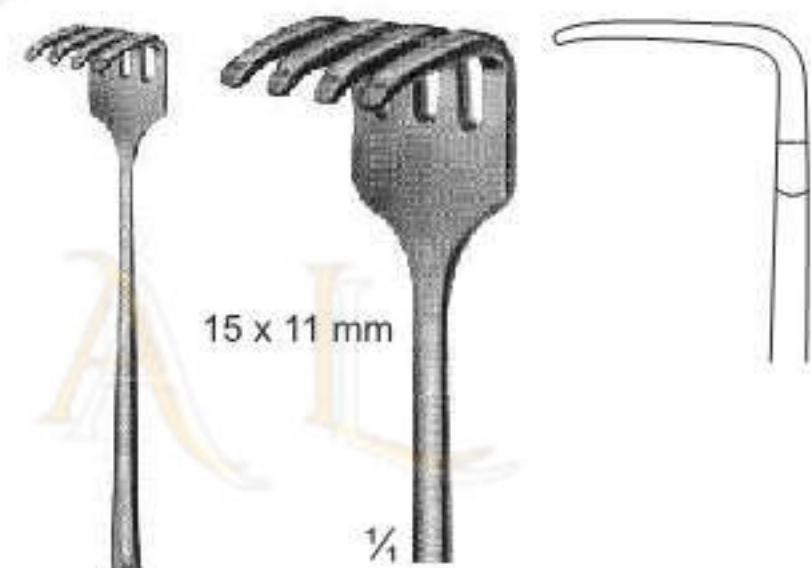
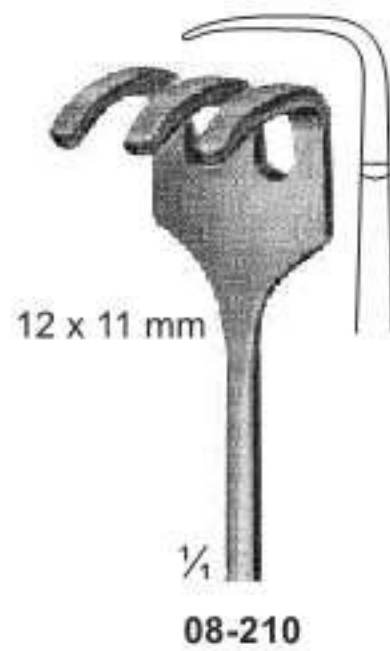

**08-211**  
KLAPP  
Tendon hooks  
175 mm

# Retractors

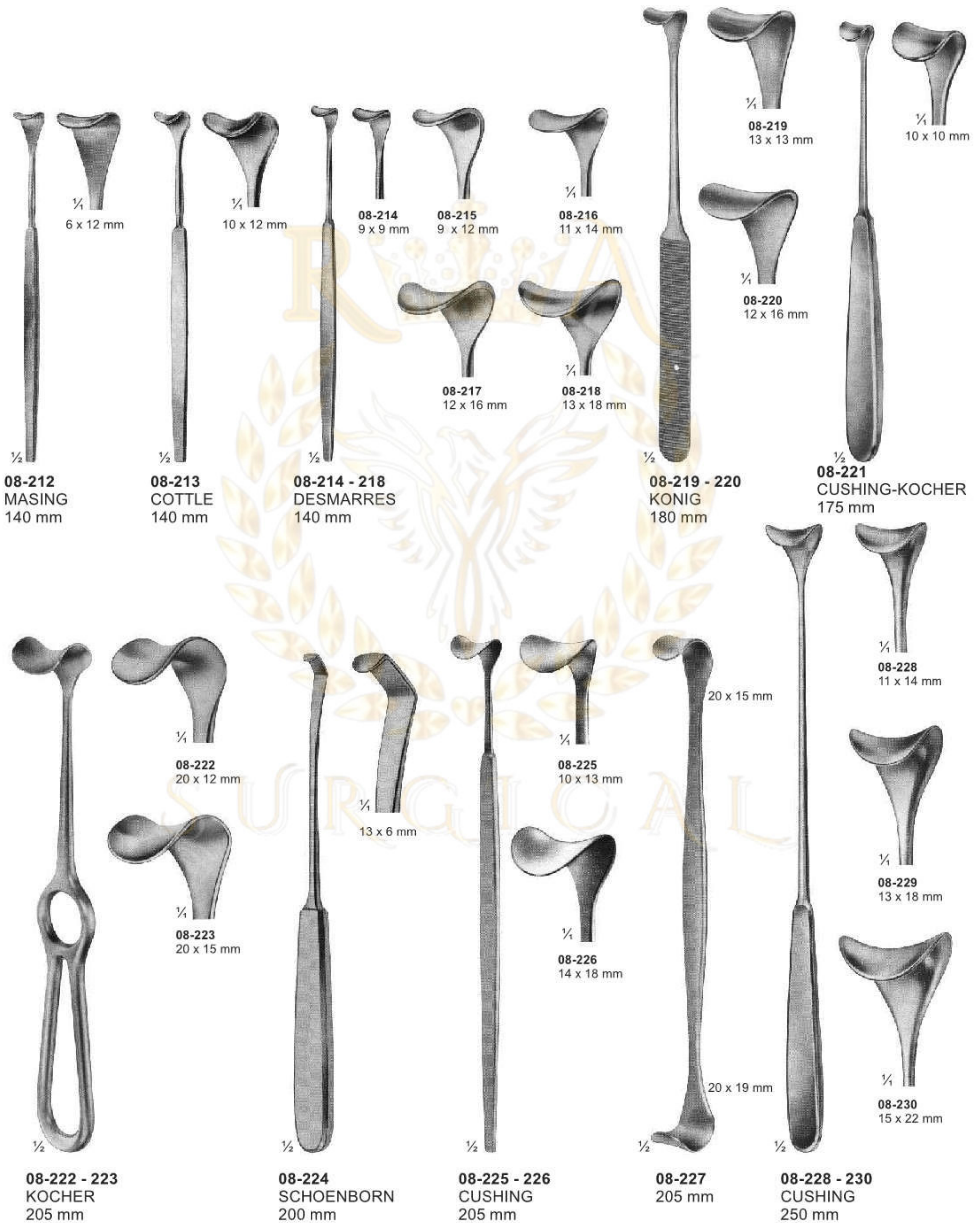

# Retractors

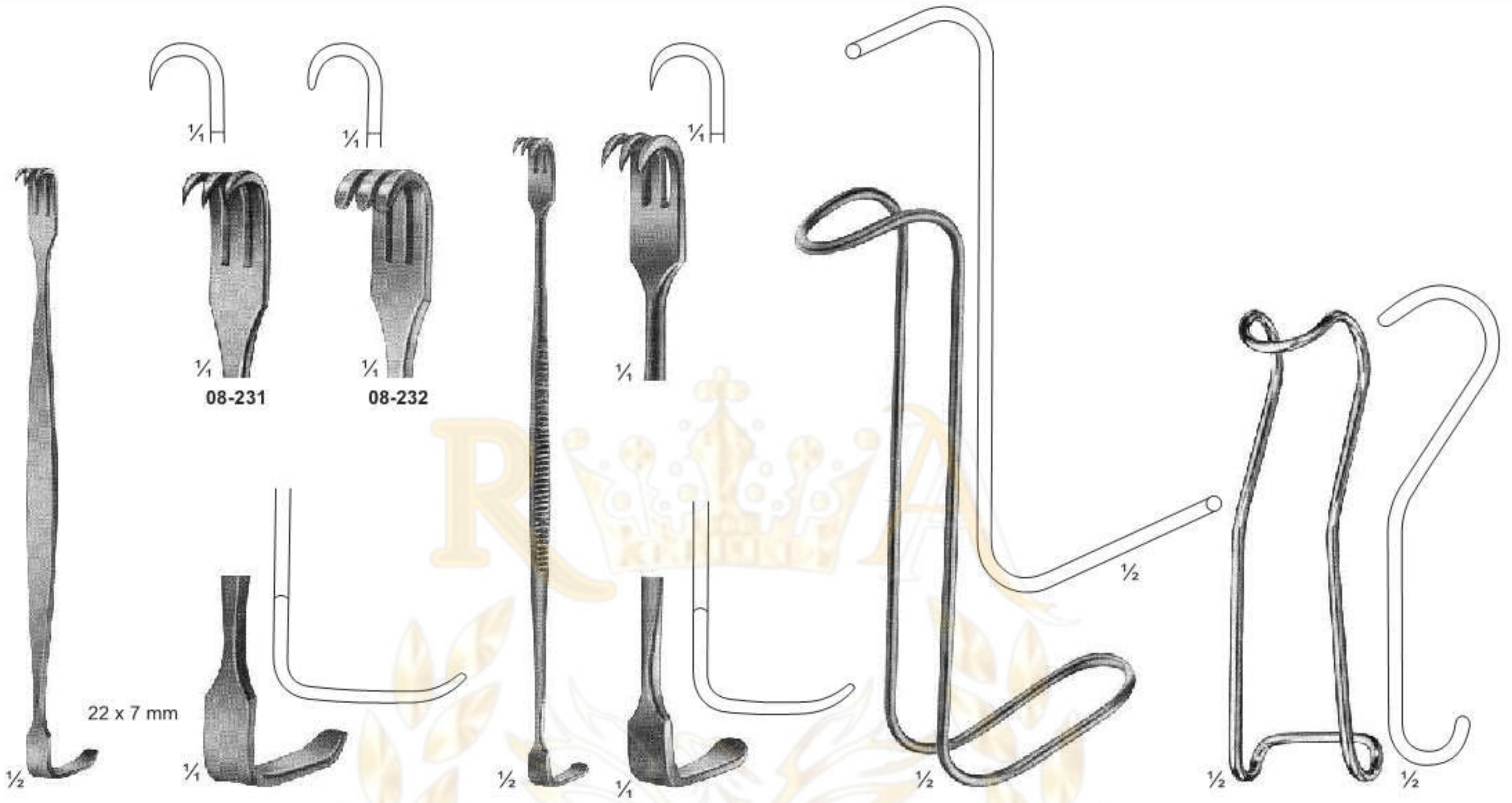

**08-231 - 232**  
BABY-SENN-MILLER  
155 mm

**08-233**  
SENN-MILLER  
165 mm

**08-234**  
COLLIN-HARTMANN  
150 mm

**STERBERG**  
08-235 120 mm  
08-236 130 mm  
08-237 135 mm  
08-238 140 mm



**08-239**  
LUER  
110 mm

**08-240**  
ROSE  
130 mm

**08-241**  
BABY-ROUX  
135 mm

**08-242**  
PARKER  
135 mm

**08-243**  
CRILE  
110 mm

**08-244**  
FARABEUF  
150 mm

**08-245**  
COLLIN  
150 mm

# Retractors



# Bone Retractors and Retractors



**08-254**  
KOCHER  
Sharp  
205 mm



**08-255**  
KOCHER  
Sharp  
220 mm



**08-256**  
KOCHER  
Blunt  
220 mm



**08-257**  
VOLKMANN  
Sharp  
220 mm



**08-258**  
VOLKMANN  
Sharp  
220 mm



**08-259 - 266**  
VOLKMANN  
225 mm

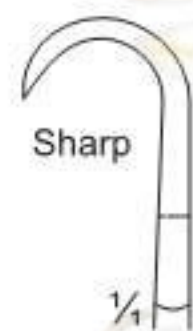

Sharp

1/4

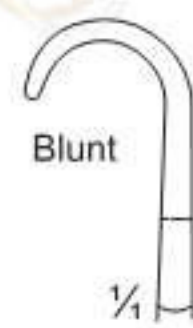

Blunt

1/4



**08-259**  
9 x 8 mm



**08-260**  
9 x 13 mm



**08-261**  
9 x 19 mm



**08-262**  
9 x 29 mm



**08-263**  
8,5 x 8 mm



**08-264**  
8,5 x 13 mm



**08-265**  
8,5 x 19 mm



**08-266**  
8,5 x 29 mm

# Retractors

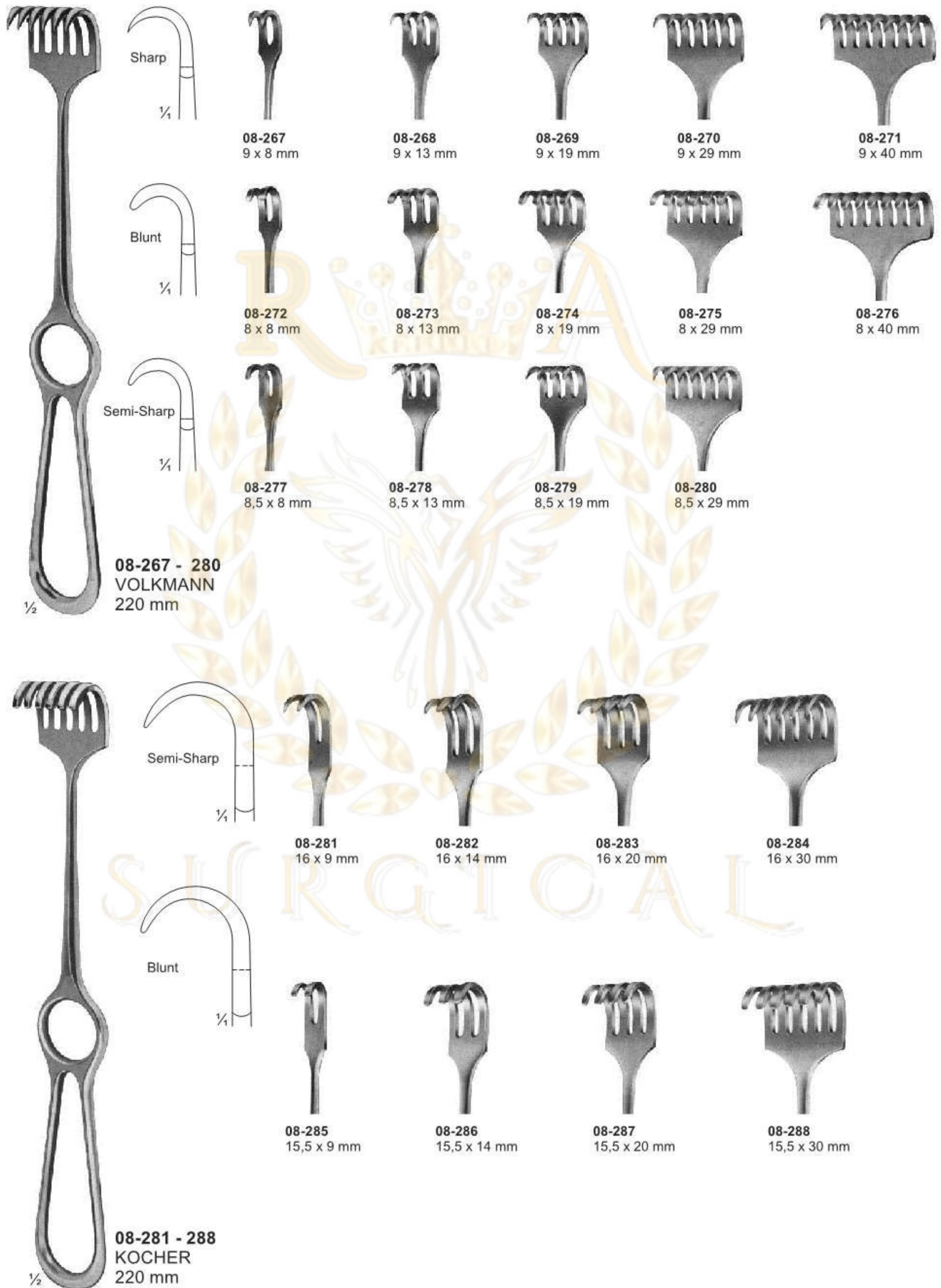

# Retractors, Deep form



# Retractors



**08-295 - 300**  
LANGENBECK  
210 mm  
08-295 28 x 10 mm  
08-296 28 x 14 mm  
08-297 33 x 14 mm  
08-298 28 x 16 mm  
08-299 40 x 10 mm  
08-300 40 x 13 mm



**08-301 - 307**  
KOCHER-LANGENBECK  
215 mm  
08-301 25 x 6 mm  
08-302 35 x 8 mm  
08-303 35 x 11 mm  
08-304 35 x 15 mm  
08-305 41 x 11 mm  
08-306 55 x 11 mm  
08-307 70 x 14 mm



**08-308**  
LANGENBECK  
215 mm



# Retractors



08-309 - 313  
KOCHER  
230 mm

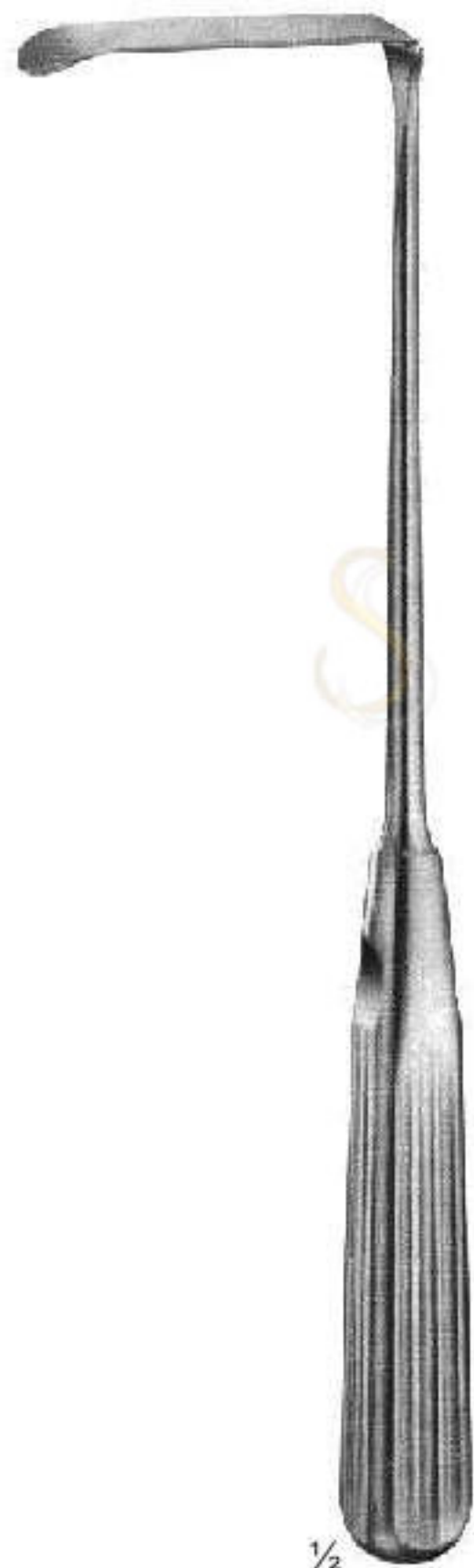

08-314 - 316  
SAUERBRUCH  
225 mm

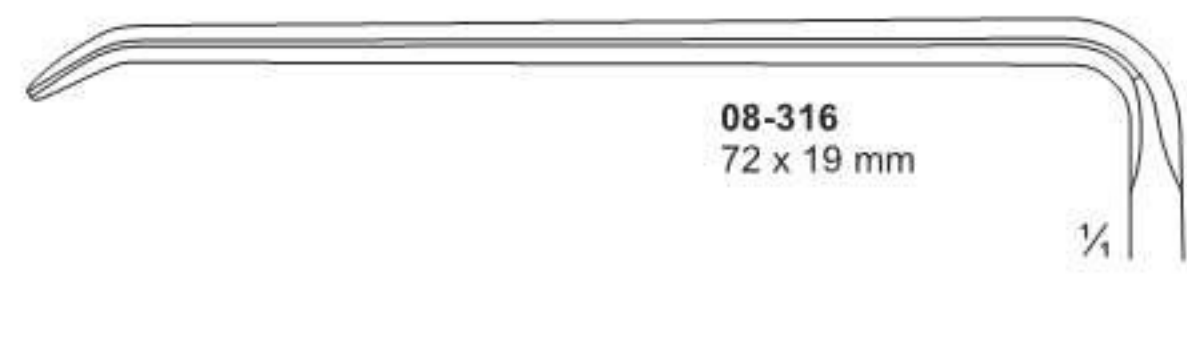
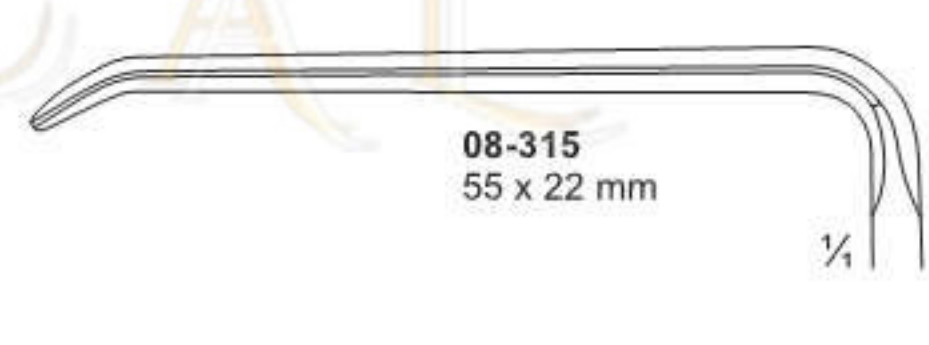
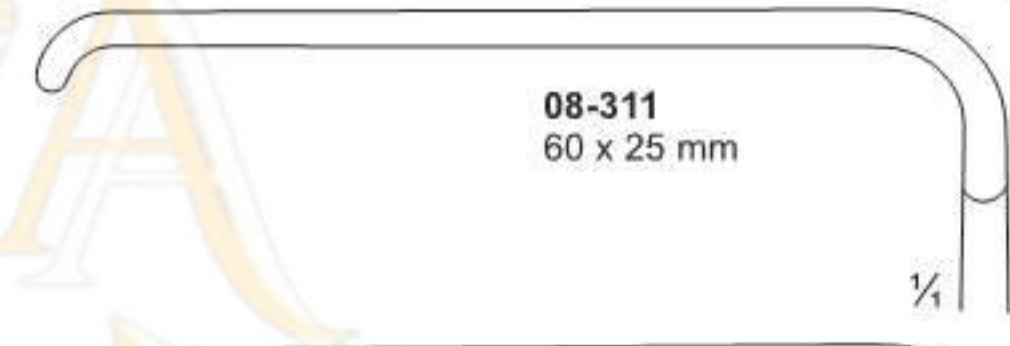
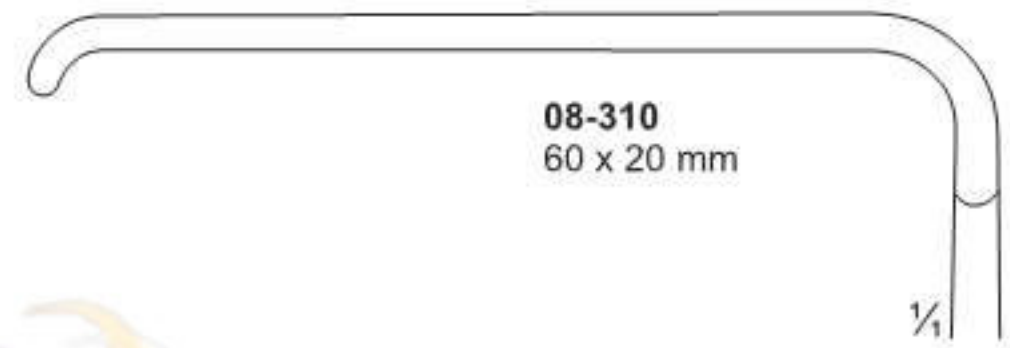
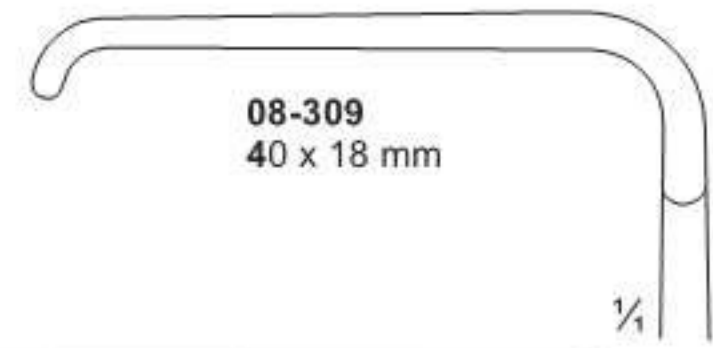

# Retractors



1/2  
**08-317 - 319**  
MIDDELDORPF



1/2  
**08-317**  
15 x 15 mm  
220 mm



1/2  
**08-318**  
20 x 22 mm  
215 mm



1/2  
**08-319**  
28 x 28 mm  
235 mm



1/4



1/4



1/4



1/2  
**08-320**  
BUCHS  
205 mm

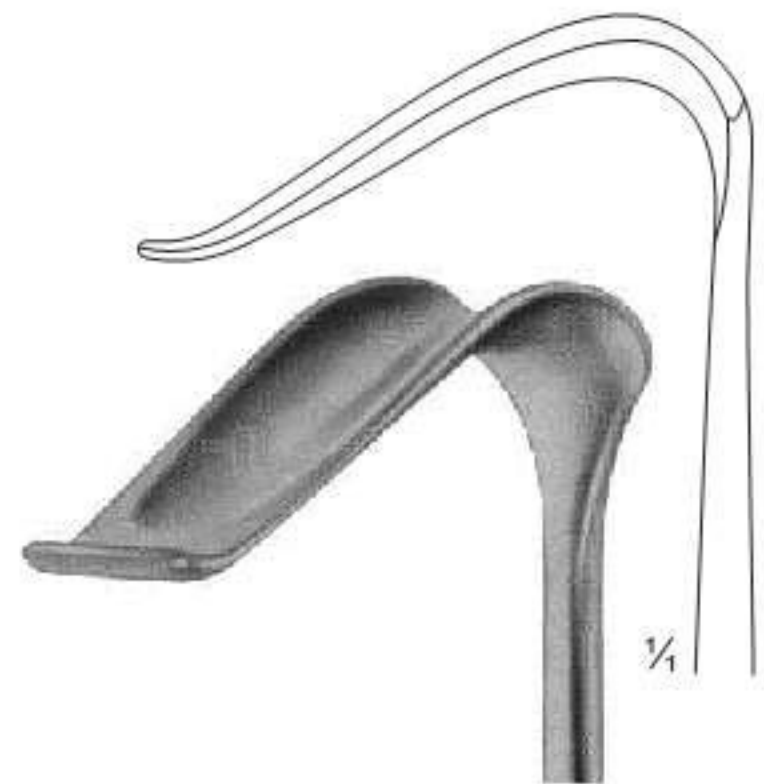

1/4

38 x 18 mm



67 x 17 mm

1/4



1/2  
**08-321**  
CASPAR  
210 mm



1/2  
**08-322**  
KOCHER  
230 mm

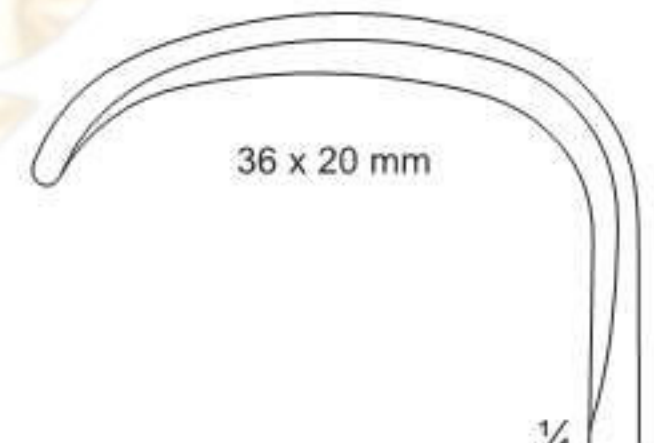

36 x 20 mm

1/4

# Retractors



1/2

**08-323 - 328**  
HOSEL  
250 mm

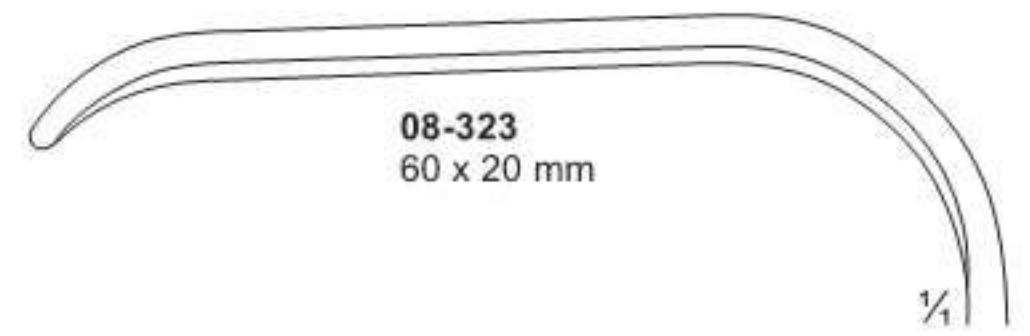

**08-323**  
60 x 20 mm

1/4

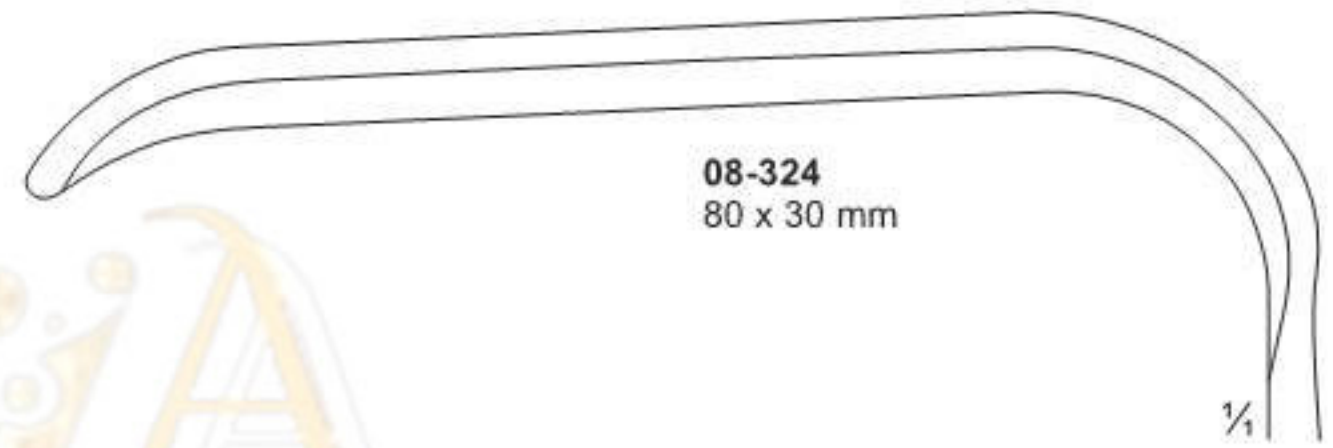

**08-324**  
80 x 30 mm

1/4



**08-325**  
100 x 30 mm

1/4



**08-326**  
120 x 30 mm

1/4



**08-327**  
140 x 30 mm

1/4

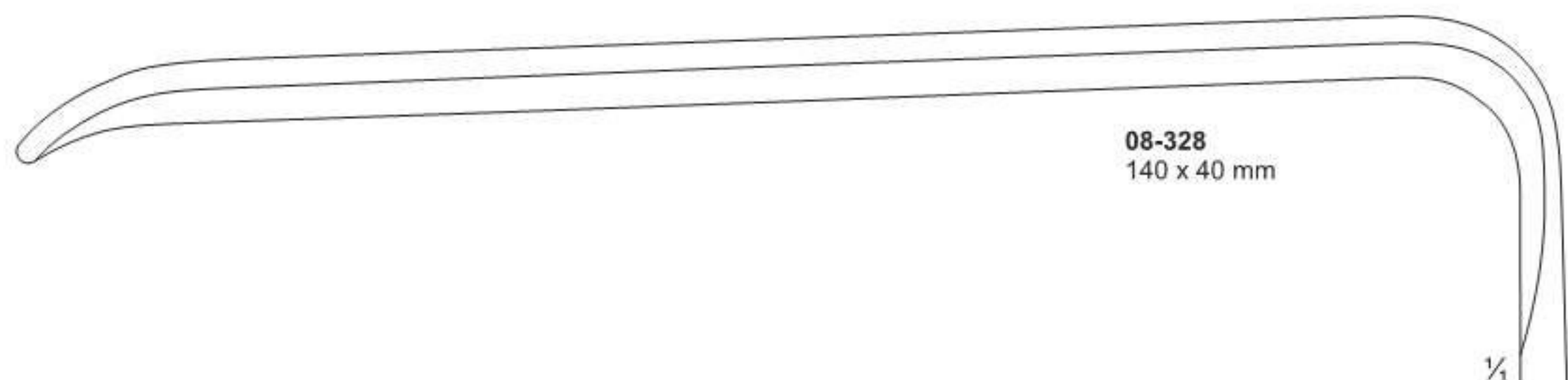

**08-328**  
140 x 40 mm

1/4

# Retractors

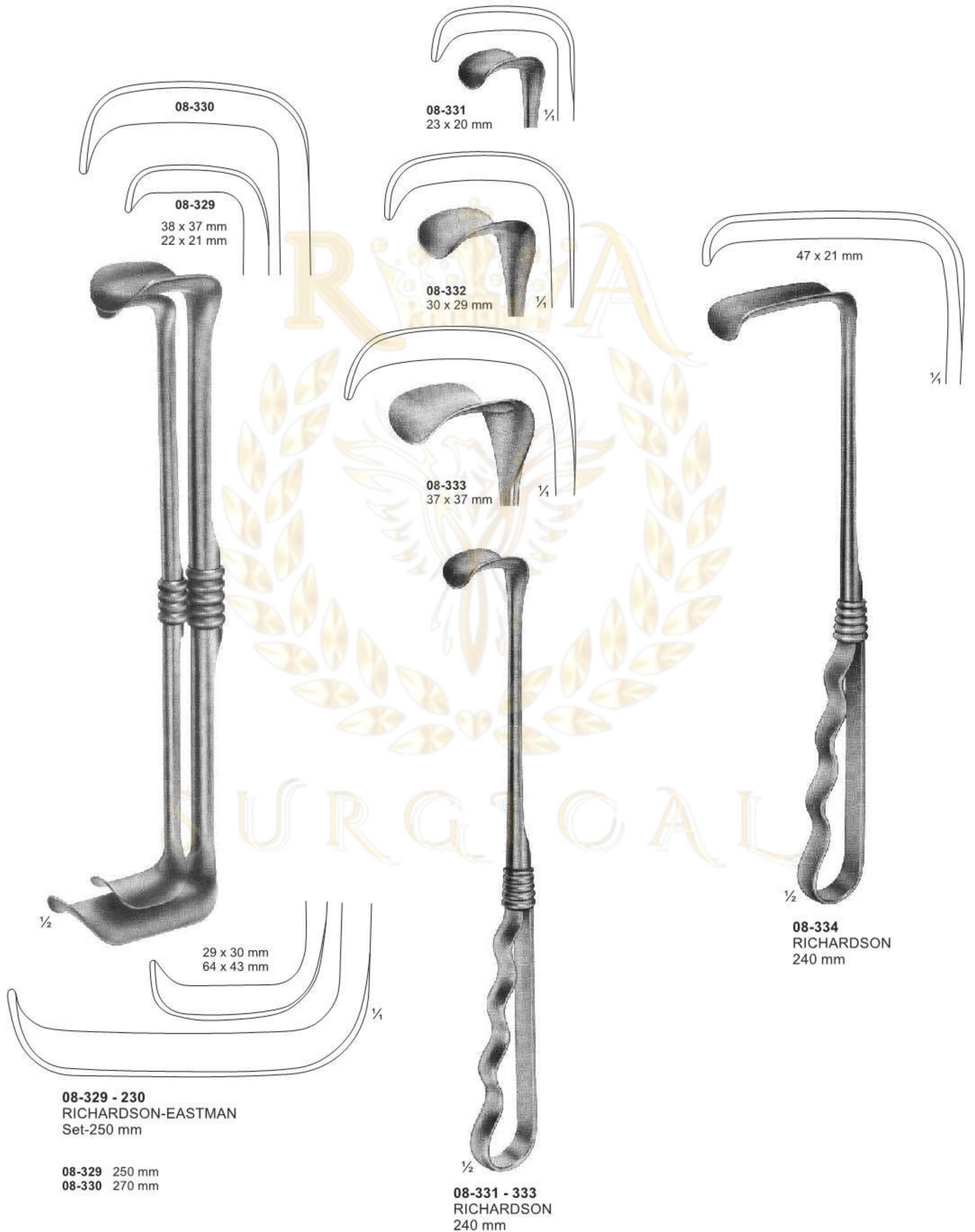

# Retractors

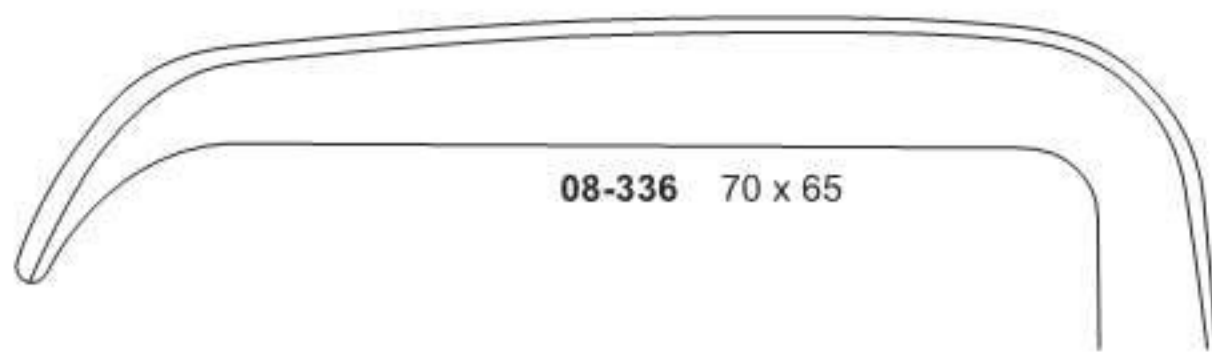

08-336 70 x 65

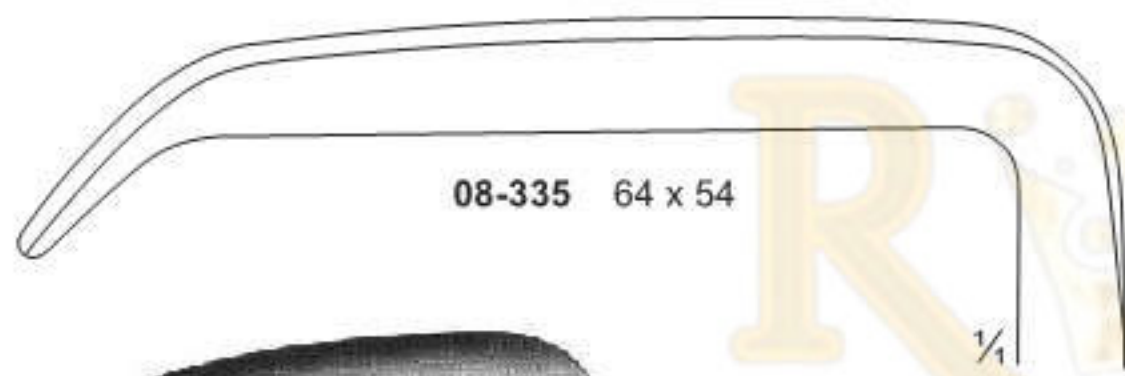

08-335 64 x 54

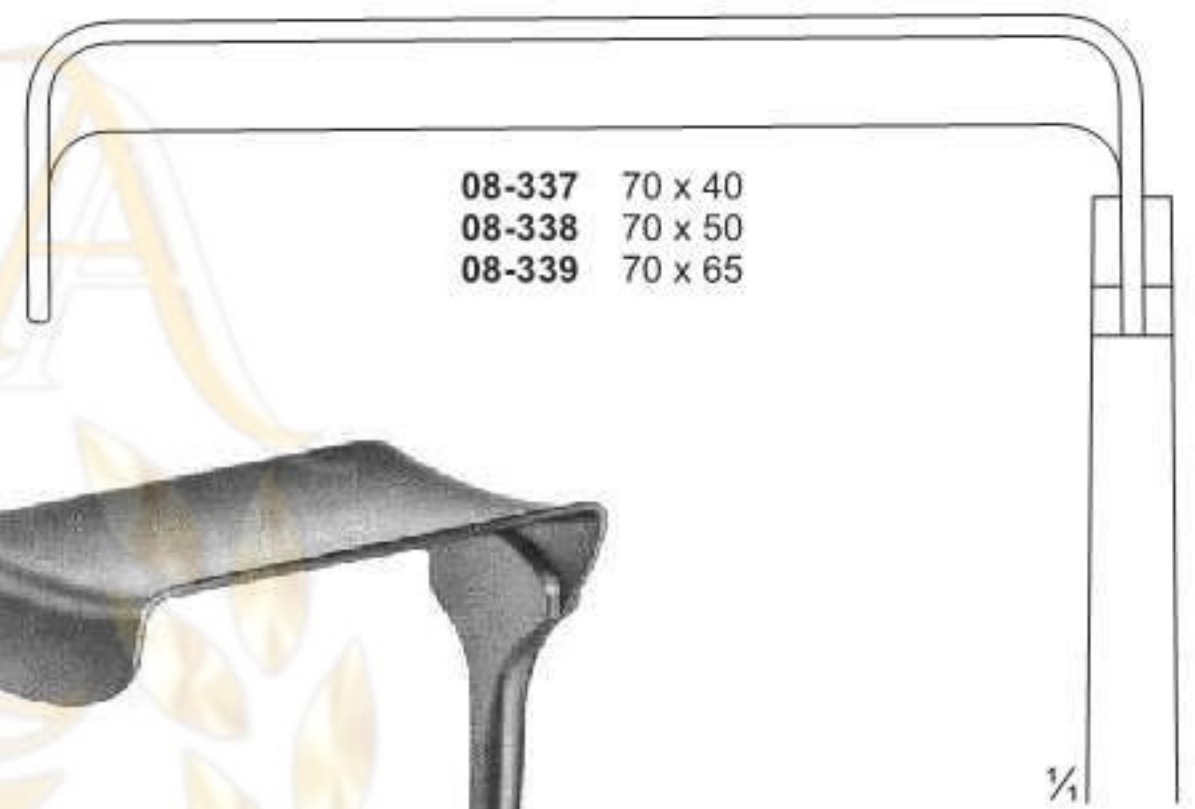

08-337 70 x 40  
08-338 70 x 50  
08-339 70 x 65

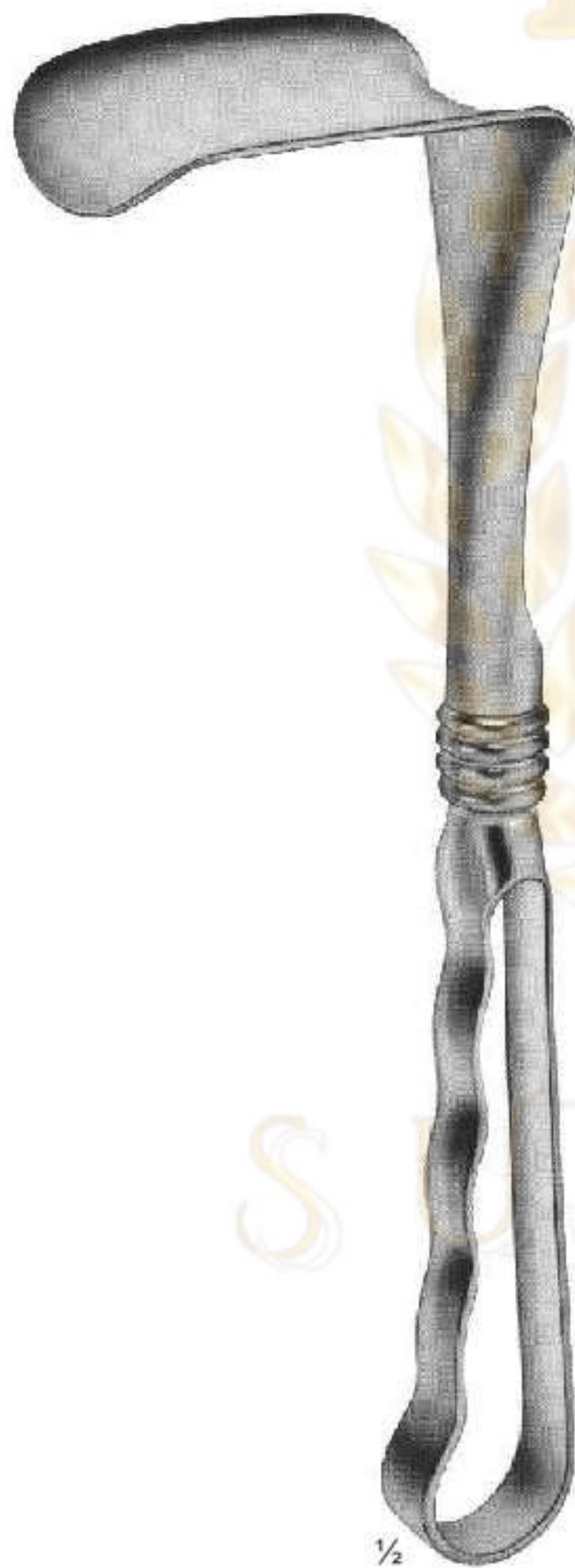

1/2

08-335 - 336  
KELLY  
260 mm



1/2

08-337 - 339  
MORRIS  
245 mm

# Retractors For Deep Surgery



# Retractors For Deep Surgery



Vario Retractor System, Germ. Fed. Patent,  
Germ. Fed. Regd.Des.



08-347 80 x 20 mm



- 08-347 - 353  
BRUNNER  
275 mm
- 08-347 80 x 20
- 08-348 100 x 25
- 08-349 120 x 25
- 08-350 130 x 30
- 08-351 140 x 30
- 08-352 160 x 30
- 08-353 180 x 30

1/2



08-354  
Handle with cold  
light carrier for  
retractor blades.  
280 mm

1/2



Handle arrange-  
ment verriable



# Retractors, Lung Spatulas

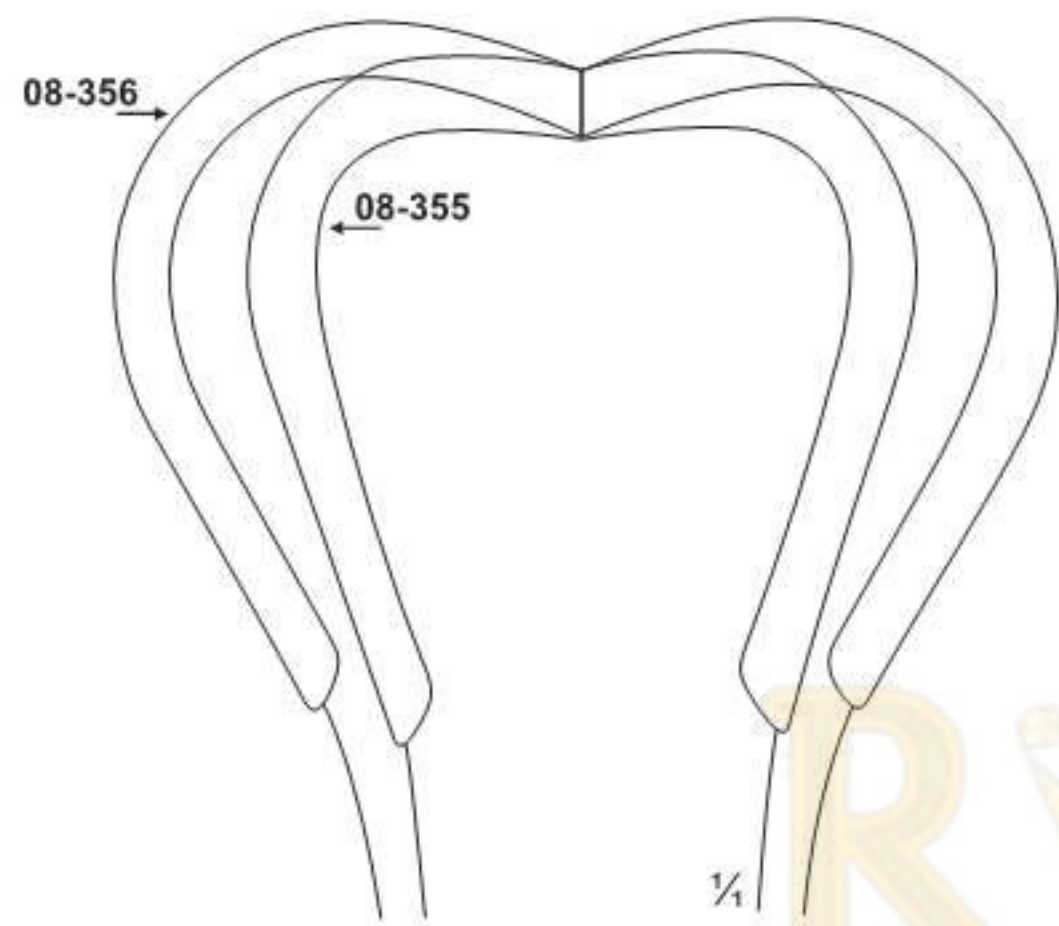

**08-355 - 356**  
**HARRINGTON**  
**08-355** 123 x 45 mm  
**08-356** 123 x 64 mm  
 Flexible  
 295 mm



**08-357**  
**ALLISON**  
 255 mm

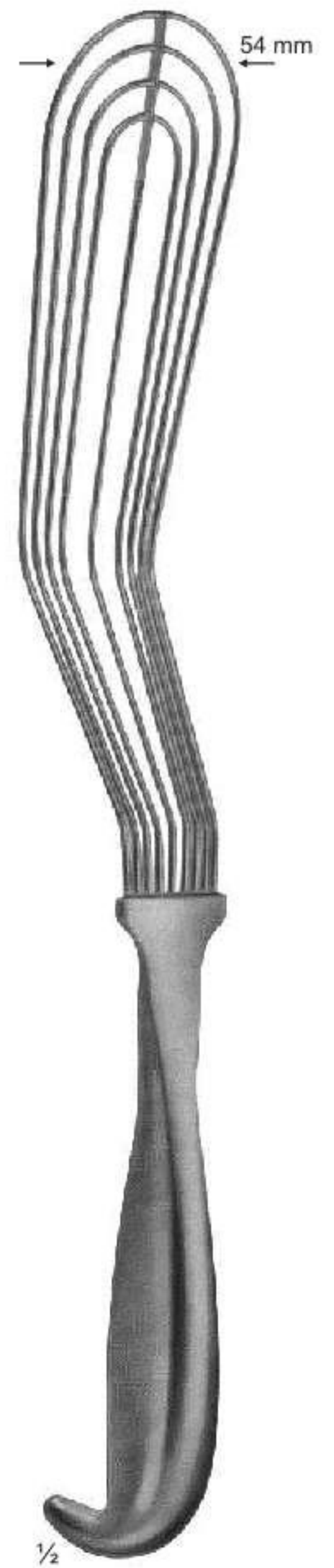

**08-358**  
**ALLISON**  
 320 mm

# Retractors, Lung Spatulas

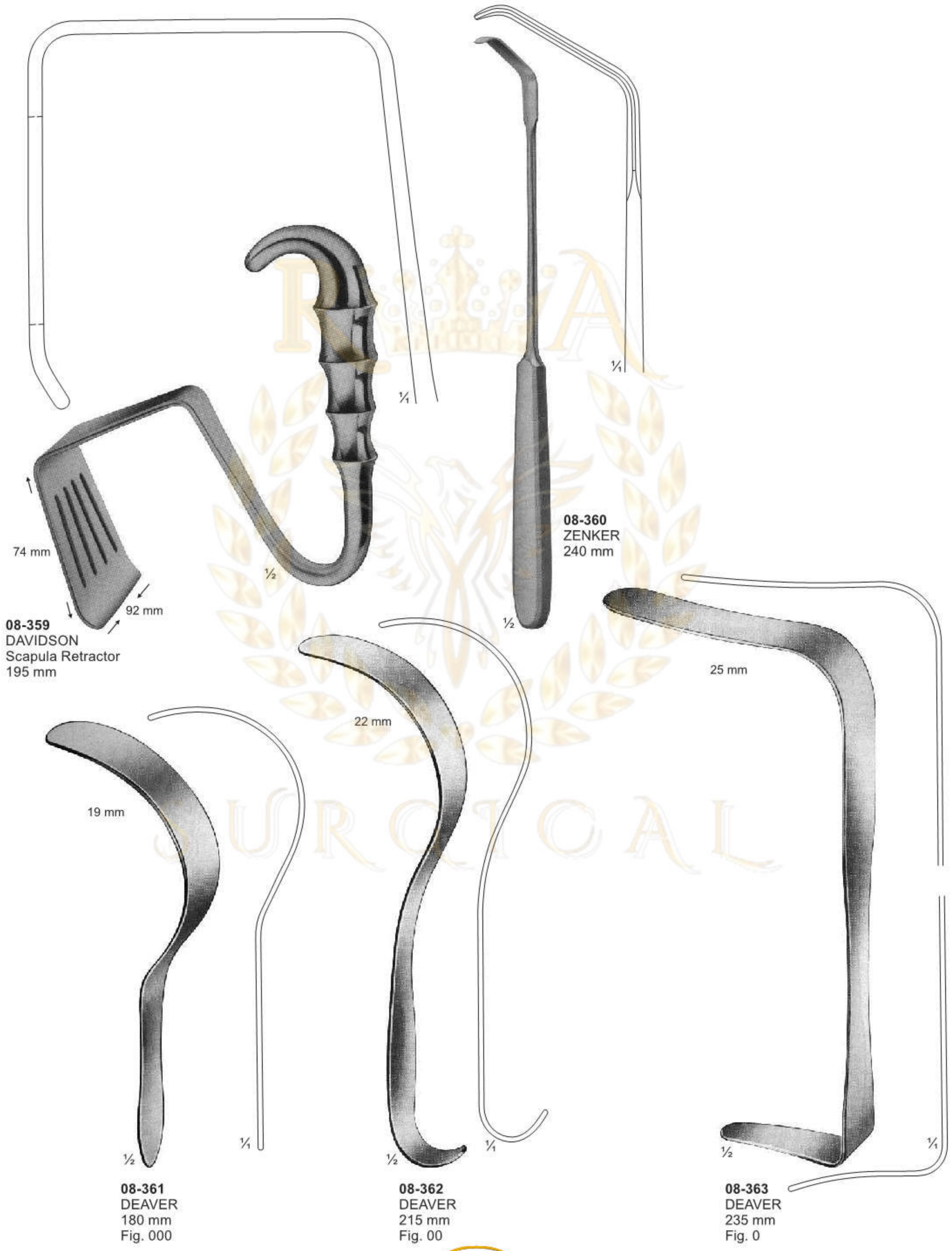

# Retractors, Lung Spatulas



**08-364**  
DEAVER  
300 mm  
Fig. 1

**08-365**  
DEAVER  
315 mm  
Fig. 2

**08-366**  
DEAVER  
365 mm  
Fig. 2

# Retractors, Lung Spatulas



**08-367**  
DEAVER  
300 mm  
Fig. 3

**08-368**  
DEAVER  
310 mm  
Fig. 4

**08-369**  
DEAVER  
320 mm  
Fig. 5

# Retractors, Lung Spatulas



**08-370**  
DEAVER  
310 mm  
Fig. 1

**08-371**  
DEAVER  
310 mm  
Fig. 3

# Retractors, Lung Spatulas



**08-372**  
DEAVER  
305 mm  
Fig. 3

**08-373**  
DEAVER  
310 mm  
Fig. 4

# Retractors For Deep Surgery (Abdominal Retractors)



# Retractors For Deep Surgery (Abdominal Retractors)



08-378 150 x 39 mm  
08-379 150 x 57 mm

08-376 121 x 50 mm  
08-377 147 x 50 mm

1/2  
08-378 - 379  
KELLY  
08-378 150 x 39 mm  
08-379 150 x 57 mm  
260 mm

08-376 - 377  
MIKULICZ  
08-376 121 x 50 mm  
08-377 147 x 50 mm  
Liver Retractor  
250 mm

1/2



# Retractors, Abdominal Retractors

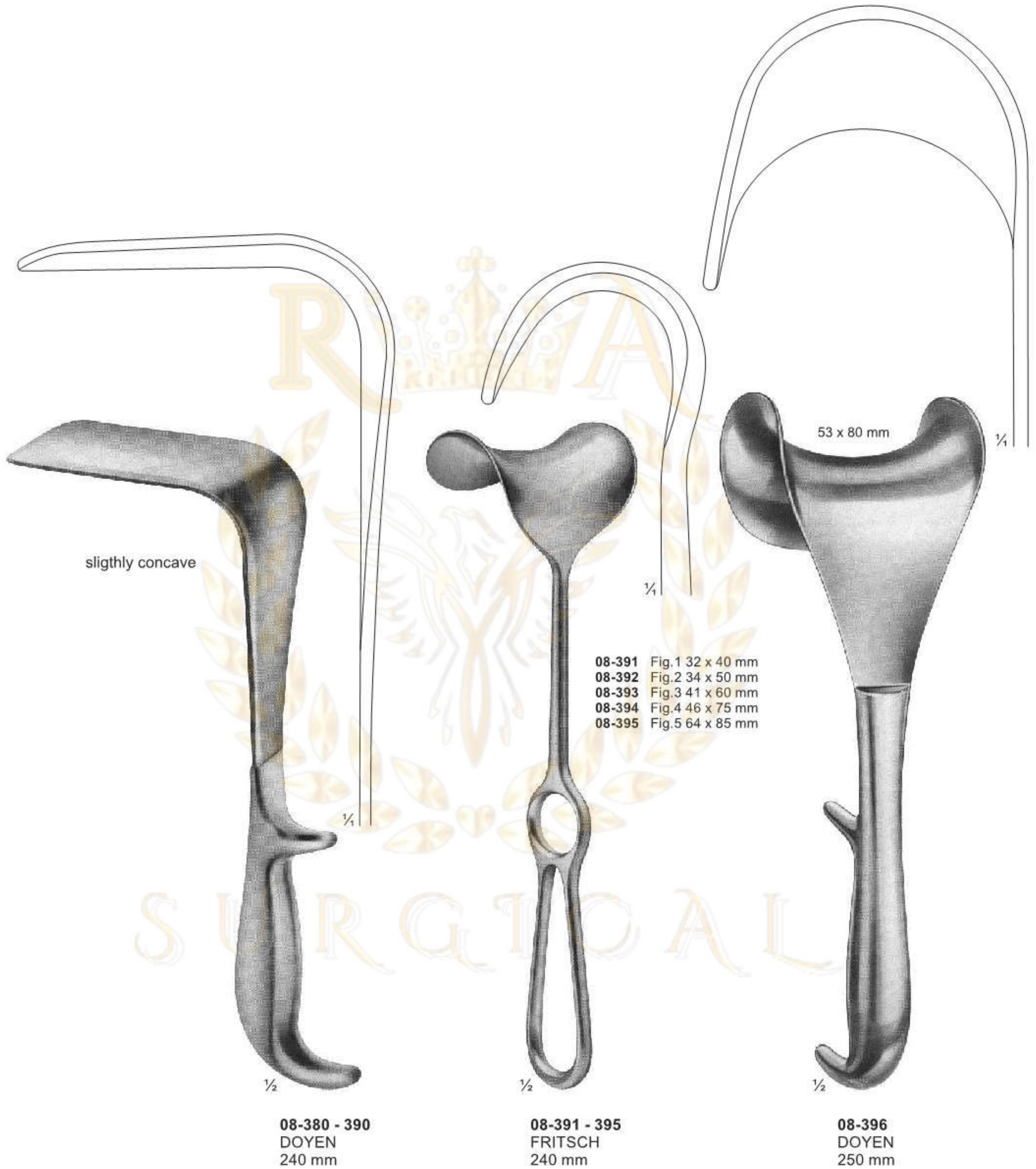

<b>Width of Blades</b>	
35 mm, 45 mm, 60 mm	
<b>Length of Blades</b>	
62 mm	08-380, 08-381, 08-382
92 mm	08-383, 08-384, 08-385
122 mm	08-386, 08-387, 08-388
160 mm	08-389, 08-390

# Abdominal Retractors



**08-397 - 401**  
**ROCHARD**  
 310 mm  
 08-397 48 x 90 mm  
 08-398 48 x 105 mm  
 08-399 48 x 120 mm  
 08-400 48 x 135 mm  
 08-401 48 x 155 mm



**08-402**



**08-403 - 406**  
**DOYEN**  
 280 mm  
 08-403 48 x 90 mm  
 08-404 48 x 105 mm  
 08-405 48 x 120 mm  
 08-406 48 x 135 mm



**08-407**  
**DOYEN-CHILD**  
 Fixation device  
 220 mm



**08-408**  
 Chain with  
 weight (747 / 645g)  
 790 mm

# Pelvis Retractors

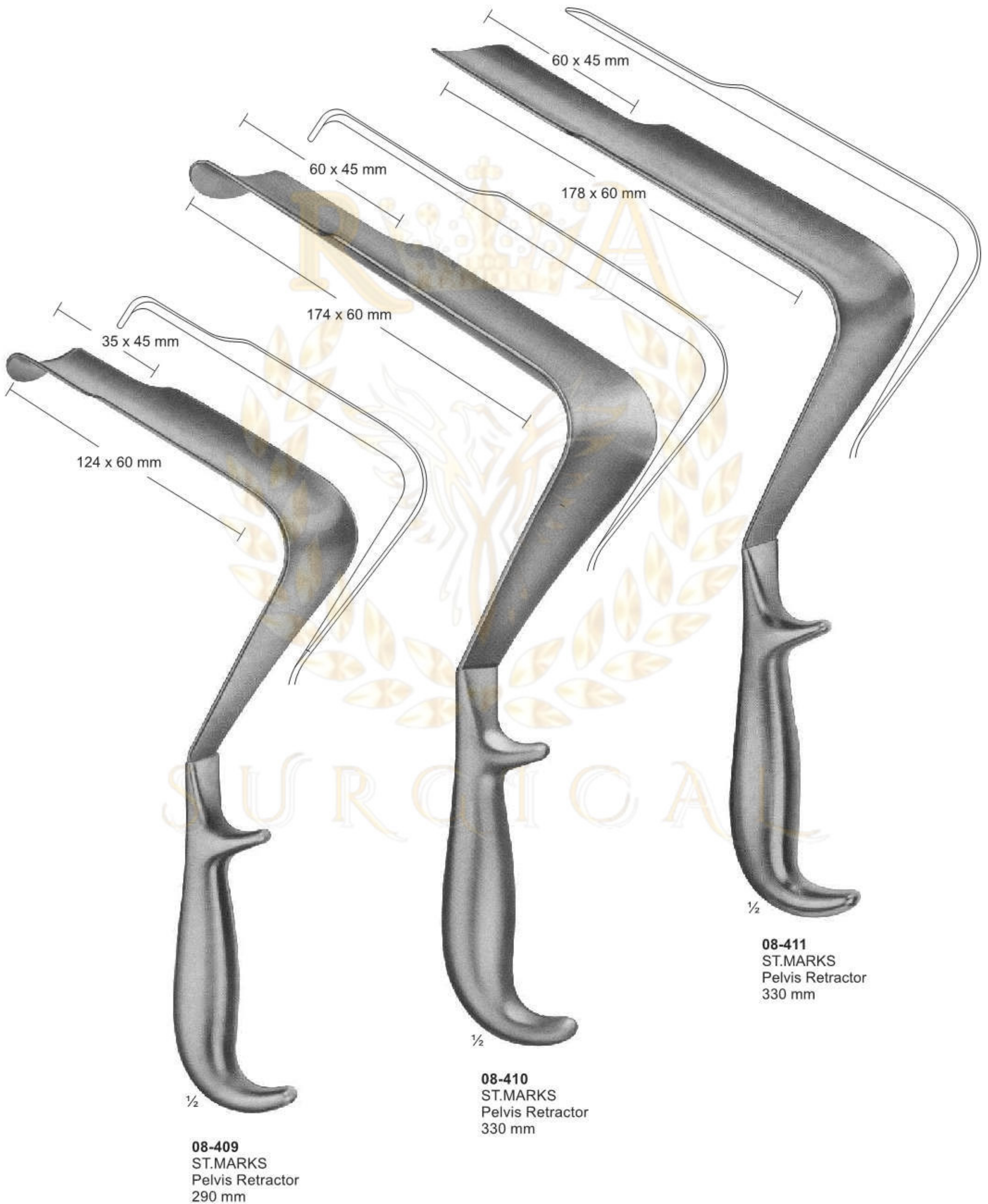

**08-409**  
ST.MARKS  
Pelvis Retractor  
290 mm

**08-410**  
ST.MARKS  
Pelvis Retractor  
330 mm

**08-411**  
ST.MARKS  
Pelvis Retractor  
330 mm

# Abdominal- and Intestinal Spatulas



**08-412**  
LERICHE  
255 mm

**08-413**  
KUMMEL  
Malleable  
285 mm

**08-414**  
MIKULICZ  
29 mm  
250 mm

**08-415 - 416**  
KADER  
08-415 30 mm  
08-416 40 mm  
270 mm

# Abdominal- and Intestinal Spatulas



45 mm  
**08-417**  
REVERDIN  
285 mm



50 mm  
**08-418**  
HABERER  
Malleable  
305 mm



**08-419** 30 mm  
**08-420** 40 mm  
**08-421** 50 mm  
Malleable  
330 mm



25 mm  
**08-422**  
TUFFIER  
Malleable  
200 mm

# Self-Retaining Retractors



**08-423**  
BOSE  
60 mm



**08-424**  
FINSEN  
50 mm



**08-425**  
FINSEN  
70 mm



**08-426**  
FINSEN modif.  
75 mm



**08-427**  
45 mm



**08-428**  
55 mm



**08-429**  
MUELLER  
65 mm



**08-430**  
100 mm



**08-431**



**08-432**



**08-431 - 432**  
ALM  
08-431 70 mm  
08-432 100 mm

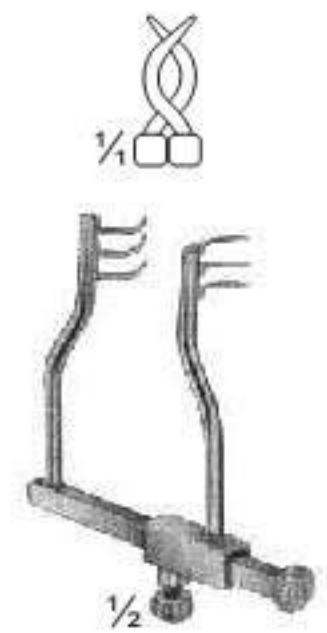

**08-433**  
LOGAN  
modif. REILL  
50 mm

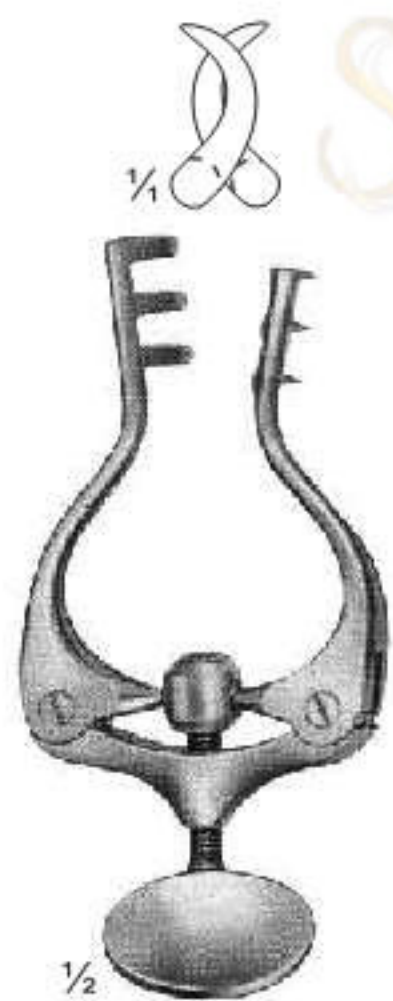

**08-434**  
JANSEN  
100 mm



**08-435**  
JANSEN  
100 mm

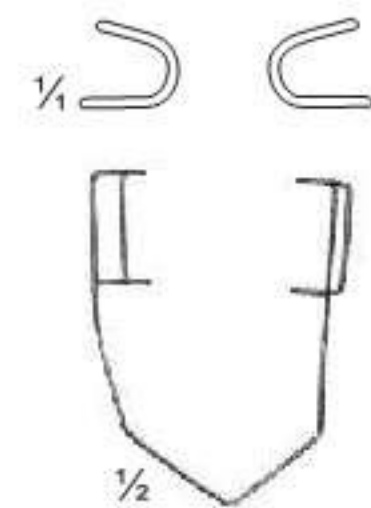

**08-436**  
BARRAQUER  
45 mm

# Self-Retaining Retractors

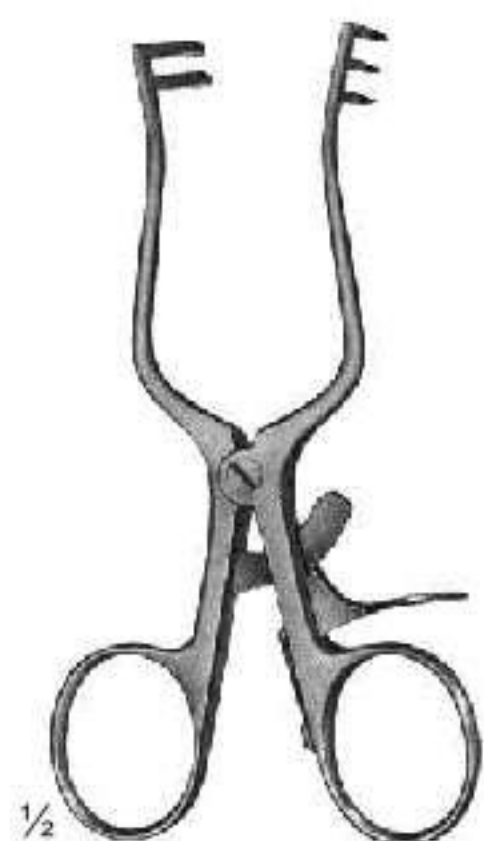

**08-437**  
WEITLANER  
Sharp  
110 mm



**08-438**  
WEITLANER  
Semi-Sharp  
110 mm

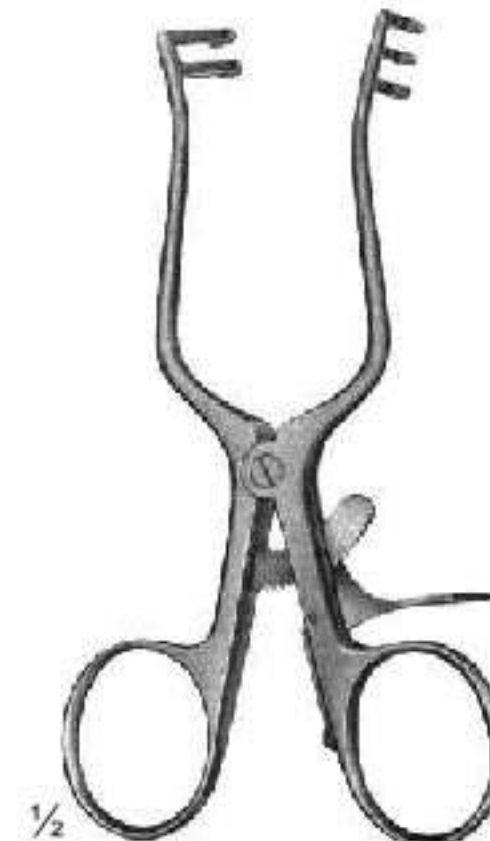

**08-439**  
WEITLANER  
Blunt  
110 mm



**08-440**  
WEITLANER  
Sharp  
130 mm



**08-441**  
WEITLANER  
Semi-Sharp  
130 mm



**08-442**  
WEITLANER  
Blunt  
130 mm

# Self-Retaining Retractors

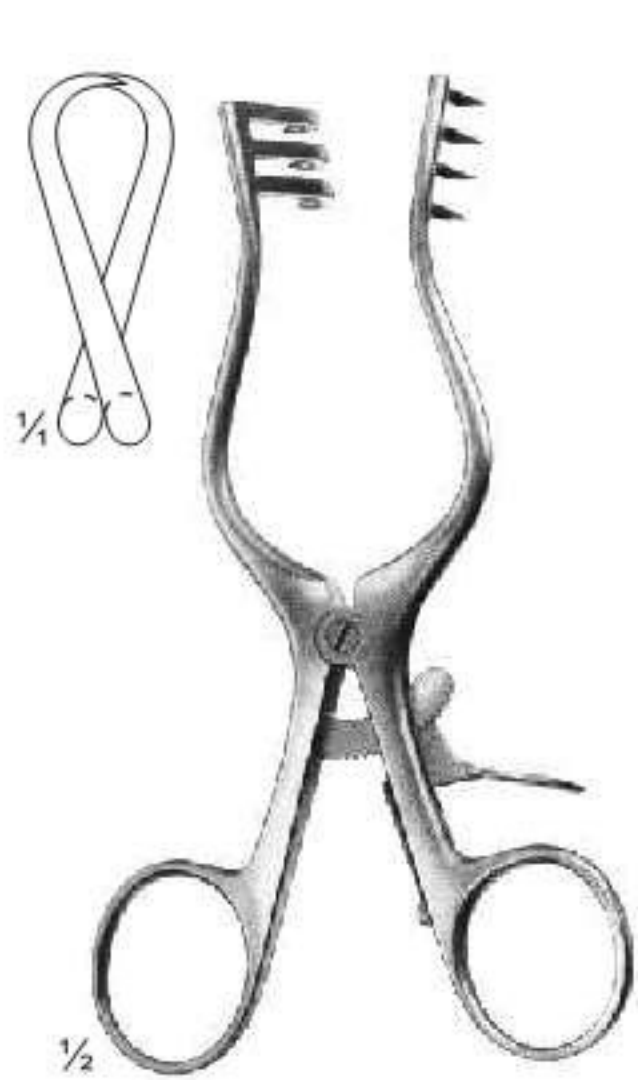

**08-443**  
WEITLANER  
Sharp  
130 mm

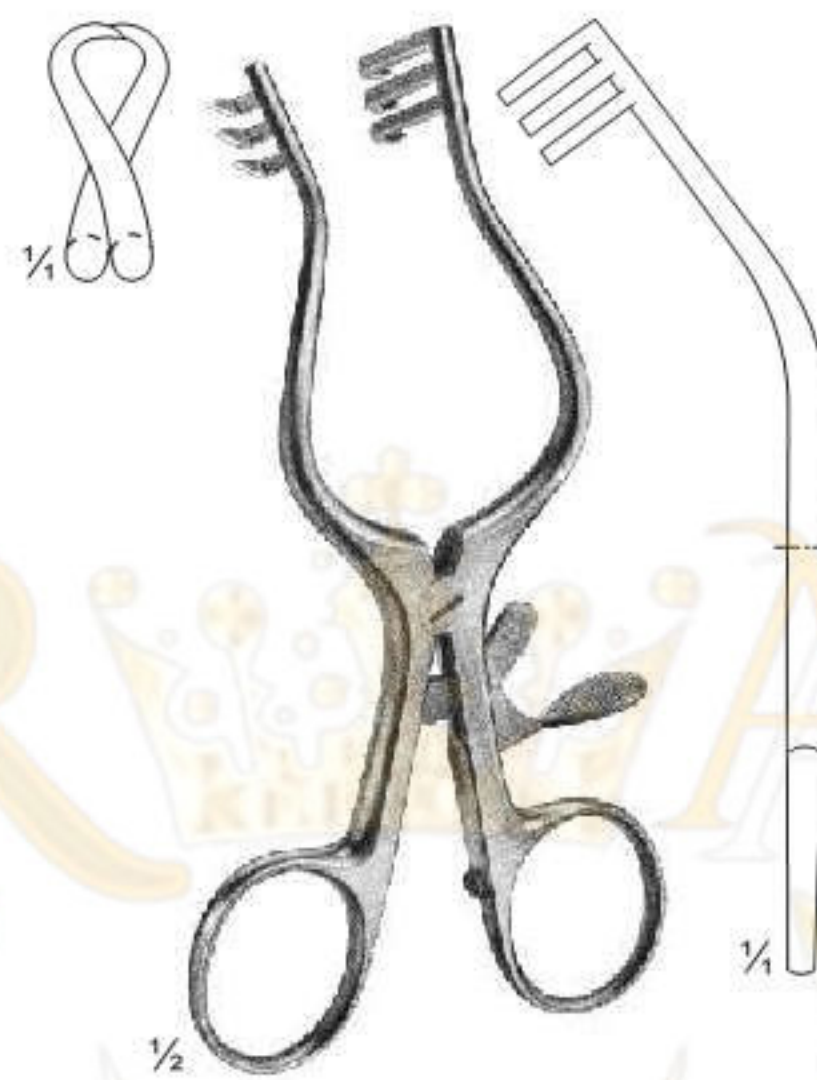

**08-444**  
WULLSTEIN  
Sharp  
130 mm

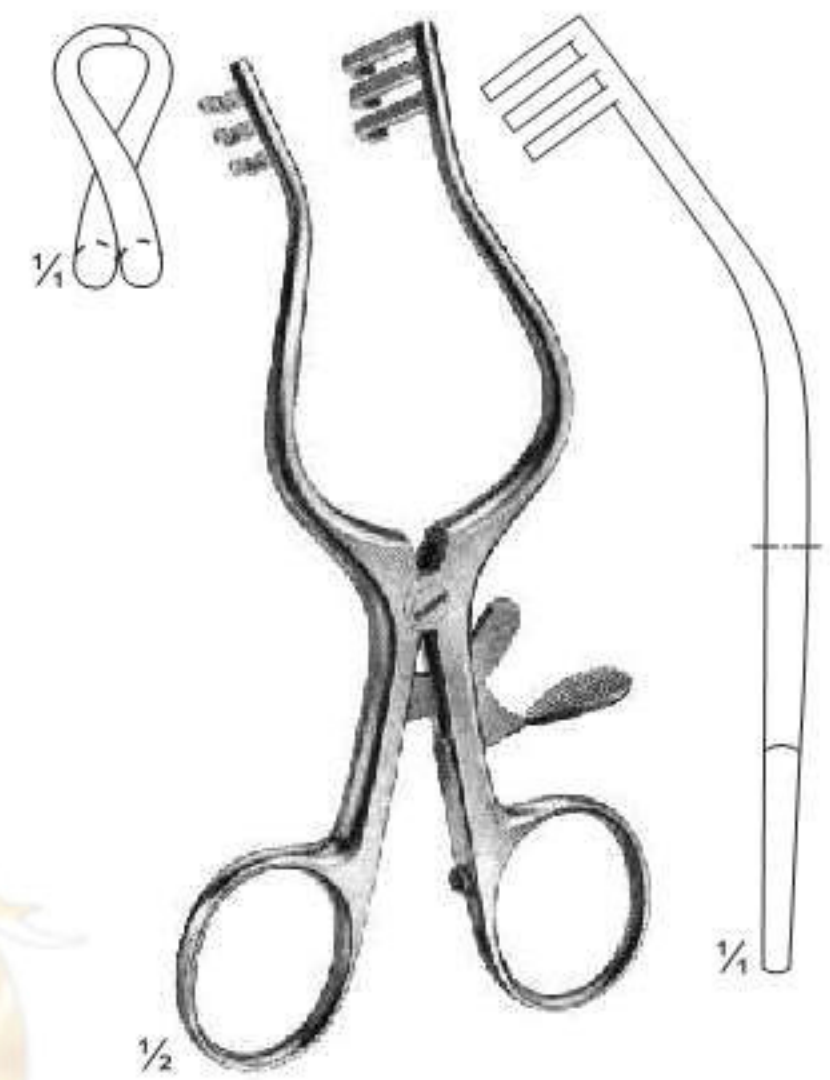

**08-445**  
WULLSTEIN  
Blunt  
130 mm



**08-446**  
WEITLANER  
Sharp  
165 mm

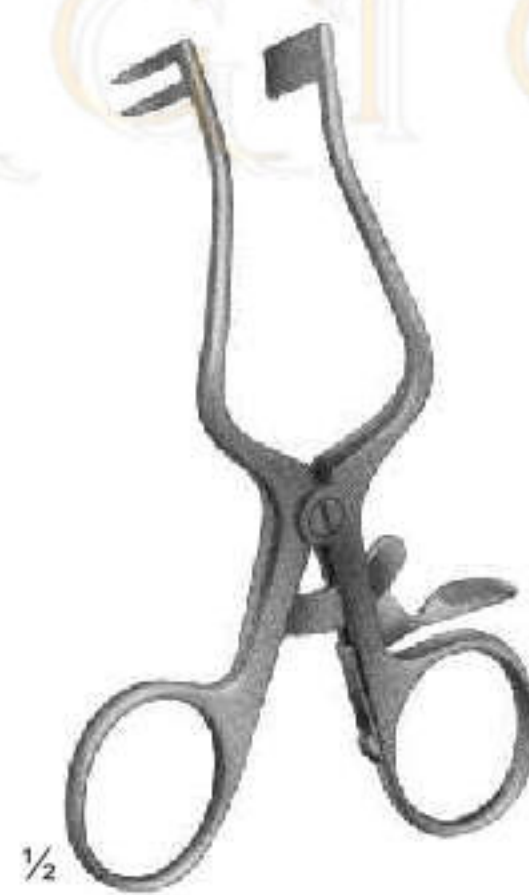

**08-447**  
PLESTER  
Blunt  
110 mm



**08-448**  
PERKINS  
130 mm



# Self-Retaining Retractors



**08-449**  
ADSON-BABY  
Blunt  
140 mm

**08-450**  
MOLLISON  
Sharp  
155 mm

**08-451**  
MAYO-ADAMS  
165 mm

# Self-Retaining Laminectomy Retractors



**08-452**  
ANDERSON-ADSON  
Sharp  
190 mm

**08-453**  
NORFOLK and  
NORWICH  
Blunt  
220 mm

**08-454**  
ADSON  
Sharp  
265 mm

# Self-Retaining Laminectomy Retractors

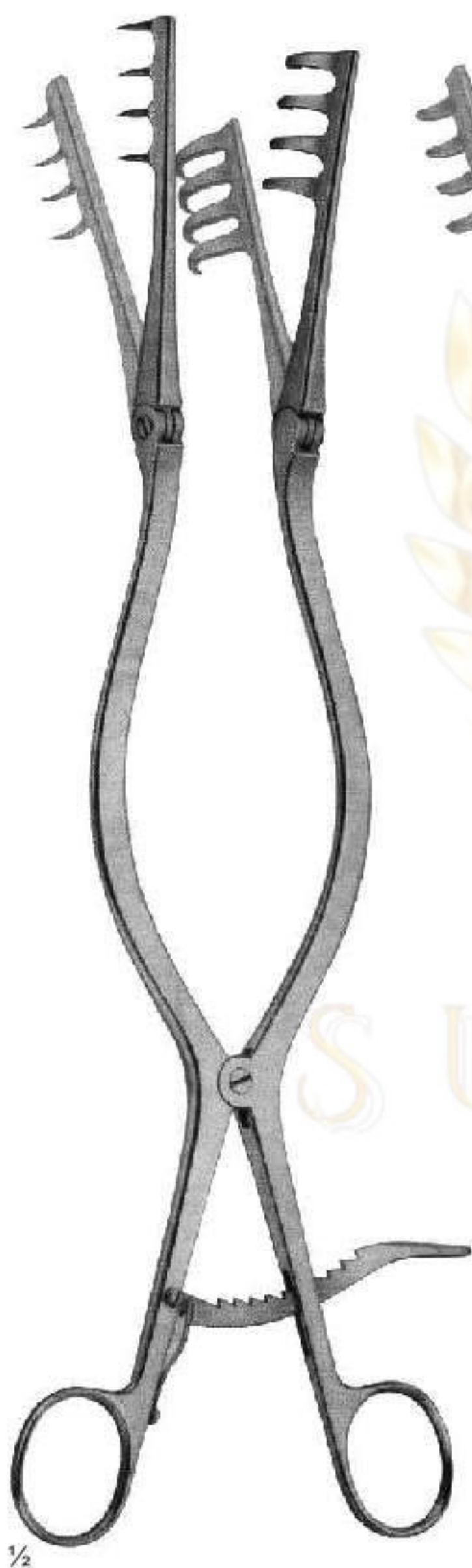
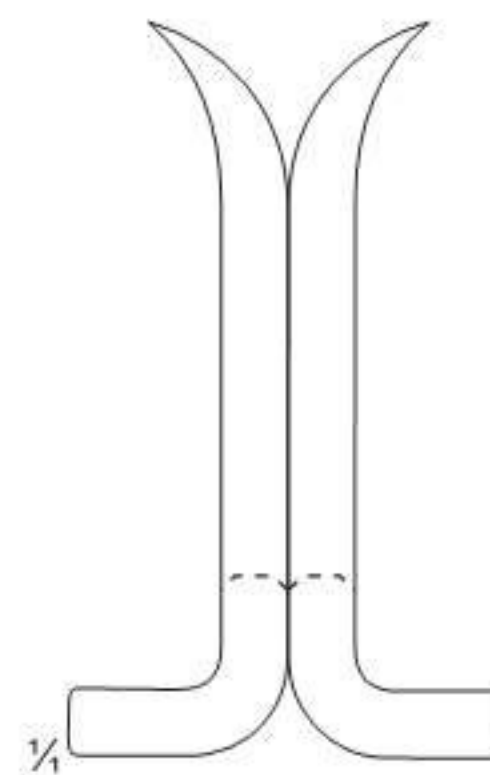
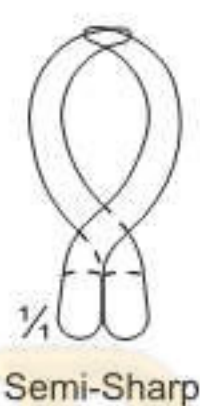
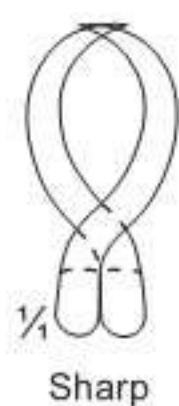

**08-455 - 456**  
BECKMANN-ADSON  
Sharp  
310 mm



**08-456**  
BECKMANN-ADSON  
Semi-Sharp  
310 mm



**08-457**  
ADSON  
Semi-Sharp  
320 mm



**08-458**  
BECKMANN-EATON  
Sharp  
320 mm

# Special Retractors



**08-459**  
JOLL ( FRIEDMAN )  
Thyroid- and Vaginal Retractor  
155 mm



**08-460**  
JACKSON BURROWS  
Retractor, blunt  
185 mm

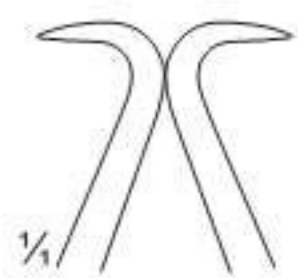

**08-461**  
GELPI  
Vaginal Retractor  
135 mm

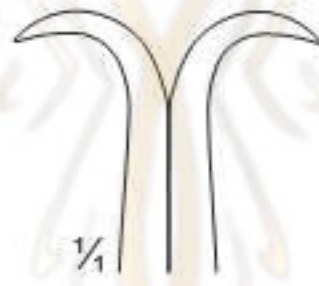

**08-462**  
GELPI  
Skin- and Vaginal Retractor  
175 mm

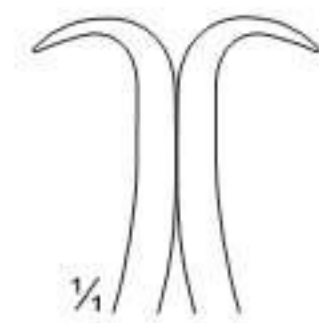

**08-463**  
DE BAKEY  
Femur Retractor  
145 mm

# Self Retaining Retractors for Laminectomy and other Operations



**08-464 - 468**  
**SCOVILLE-RICHTER**  
 Retractor with 1 pair  
 blades reversible type.  
 The Retractor bar and  
 shanks may be easily  
 rotated 180° when  
 blades are in situ.



**08-465**  
 62 x 52 mm    62 x 37 mm  
 PR= Pair



**08-466**  
 47 x 51 mm



**08-467**  
 30 x 40 mm



**08-468**  
 37 x 62 mm

# Retractors for Cervical Spine

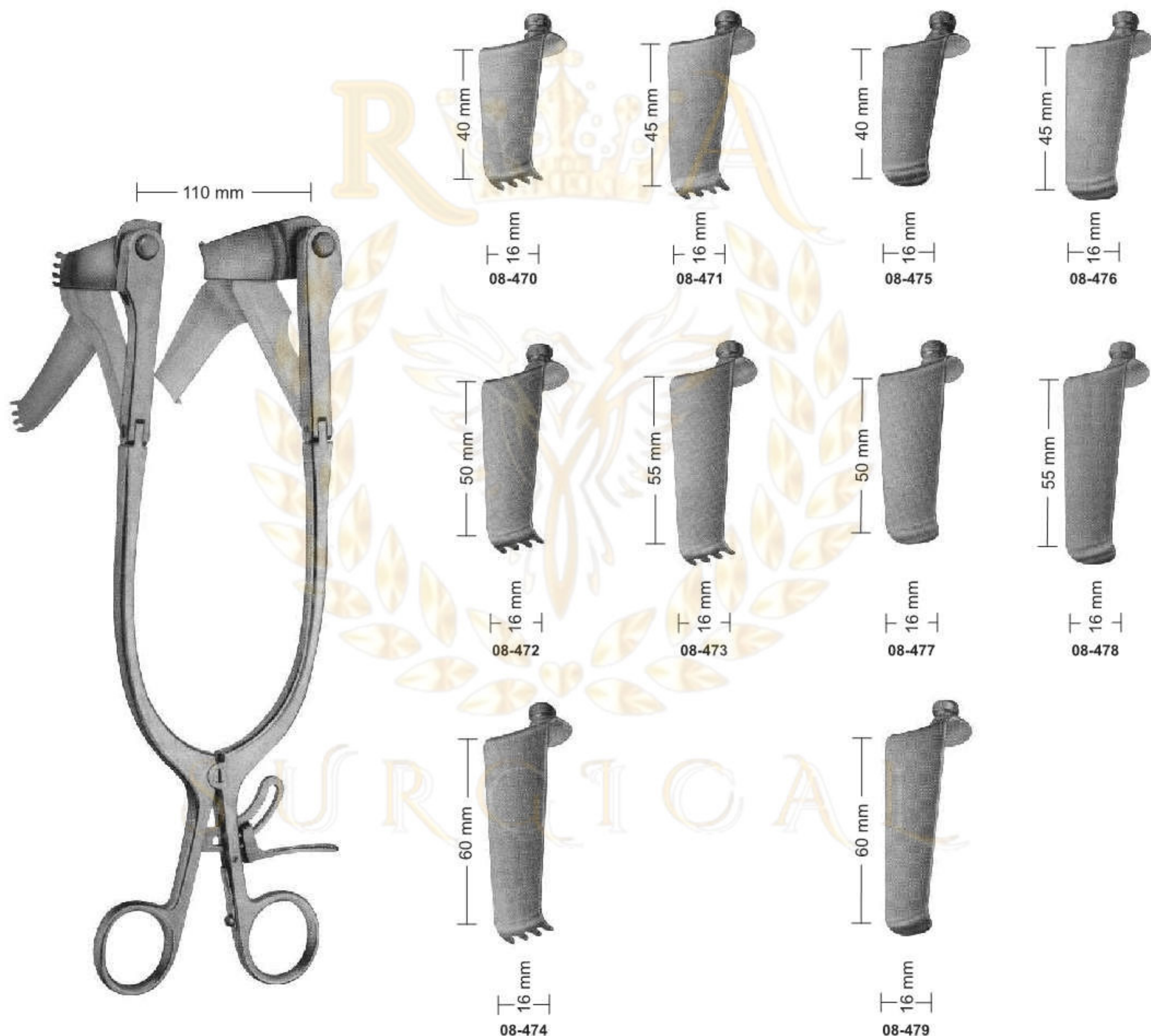

**08-469**  
CLOWARD modif.  
Spreader Only

08-470 blade  
08-471 blade  
08-472 blade  
08-473 blade  
08-474 blade

08-475 blade  
08-476 blade  
08-477 blade  
08-478 blade  
08-479 blade

# Retractors for Cervical Vertebral Column

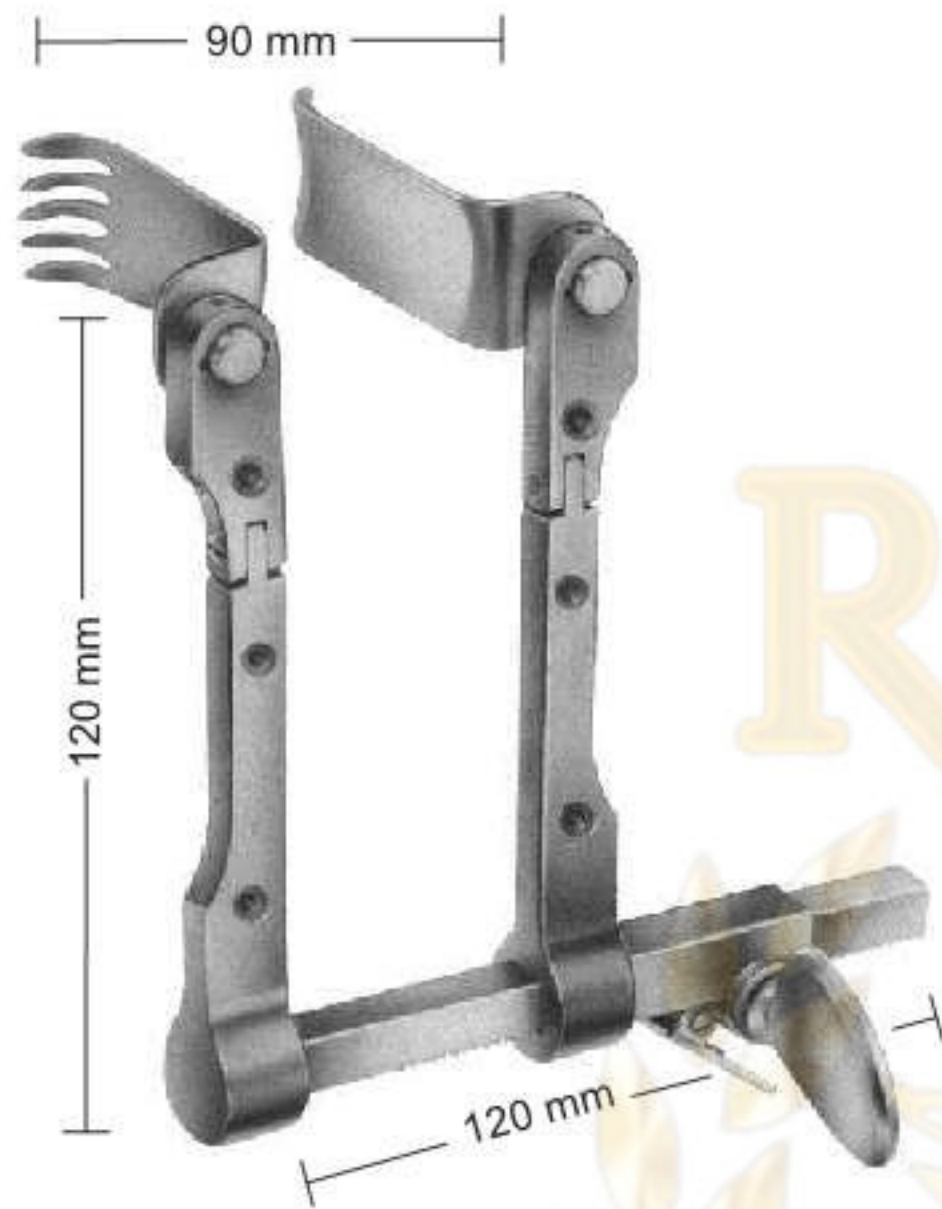

**08-480**  
CASPAR  
Retractor, adjustable,  
consisting of: 5 medial  
blades, 5 Lateral blades.

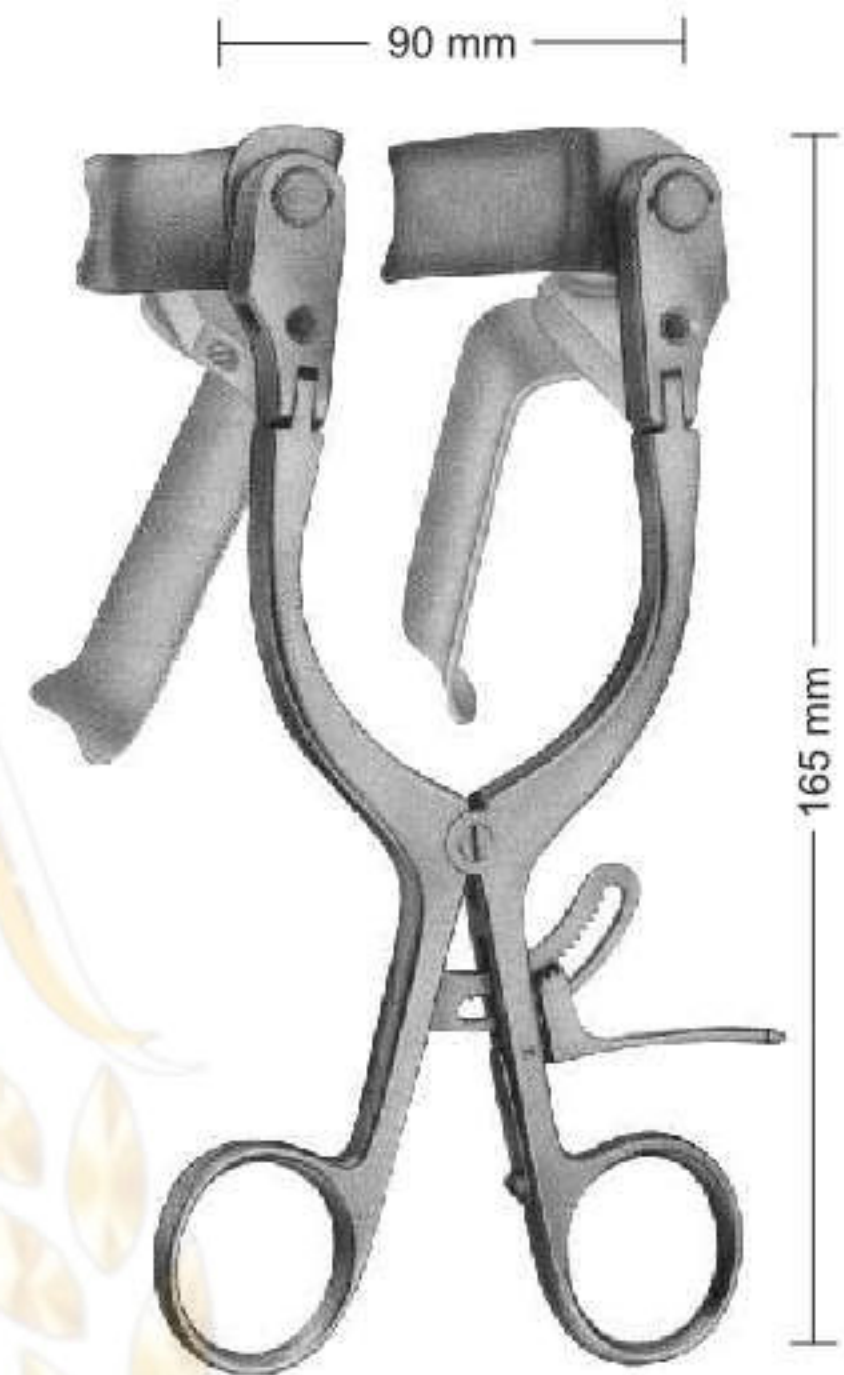

**08-480 A**  
CASPAR  
Counter retractor, adjustable,  
consisting of: 5 blades.



**08-481** 40 x 23 mm  
**08-482** 45 x 23 mm  
**08-483** 50 x 23 mm  
**08-484** 55 x 23 mm  
**08-485** 60 x 23 mm  
Medial blades



**08-486** 40 x 23 mm  
**08-487** 45 x 23 mm  
**08-488** 50 x 23 mm  
**08-489** 55 x 23 mm  
**08-490** 60 x 23 mm  
Lateral blades



**08-491** 45 x 23 mm  
**08-492** 50 x 23 mm  
**08-493** 55 x 23 mm  
**08-494** 60 x 23 mm  
**08-495** 65 x 23 mm  
Blunt blades



**08-496** 50 x 25 mm  
**08-497** 60 x 25 mm  
Blunt blades,  
for harvesting of the  
fusion graft from the  
iliac crest



**08-498** 40 x 25 mm  
**08-499** 45 x 25 mm  
**08-500** 50 x 25 mm  
**08-501** 55 x 25 mm  
**08-502** 60 x 25 mm  
Medial Titan blades  
semi transparent to x-ray



**08-503** 40 x 25 mm  
**08-504** 45 x 25 mm  
**08-505** 50 x 25 mm  
**08-506** 55 x 25 mm  
**08-507** 60 x 25 mm  
Lateral Titan blades  
semi transparent to x-ray

# Lamina Spreaders



**08-508**  
CLOWARD  
155 mm



**08-509**  
CLOWARD  
135 mm



**08-510**  
INGE  
170 mm

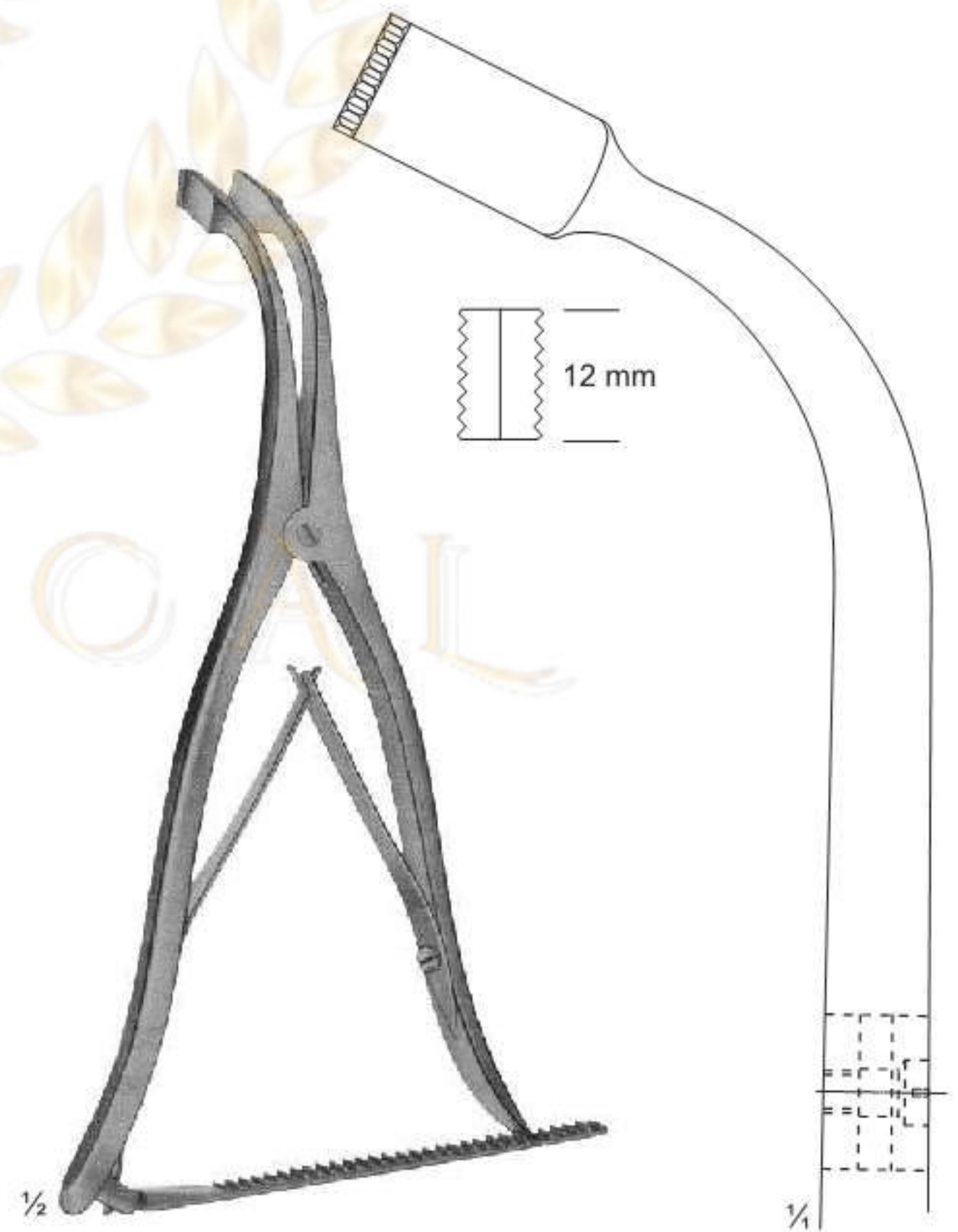

**08-511**  
INGE  
275 mm



# Abdominal Retractors

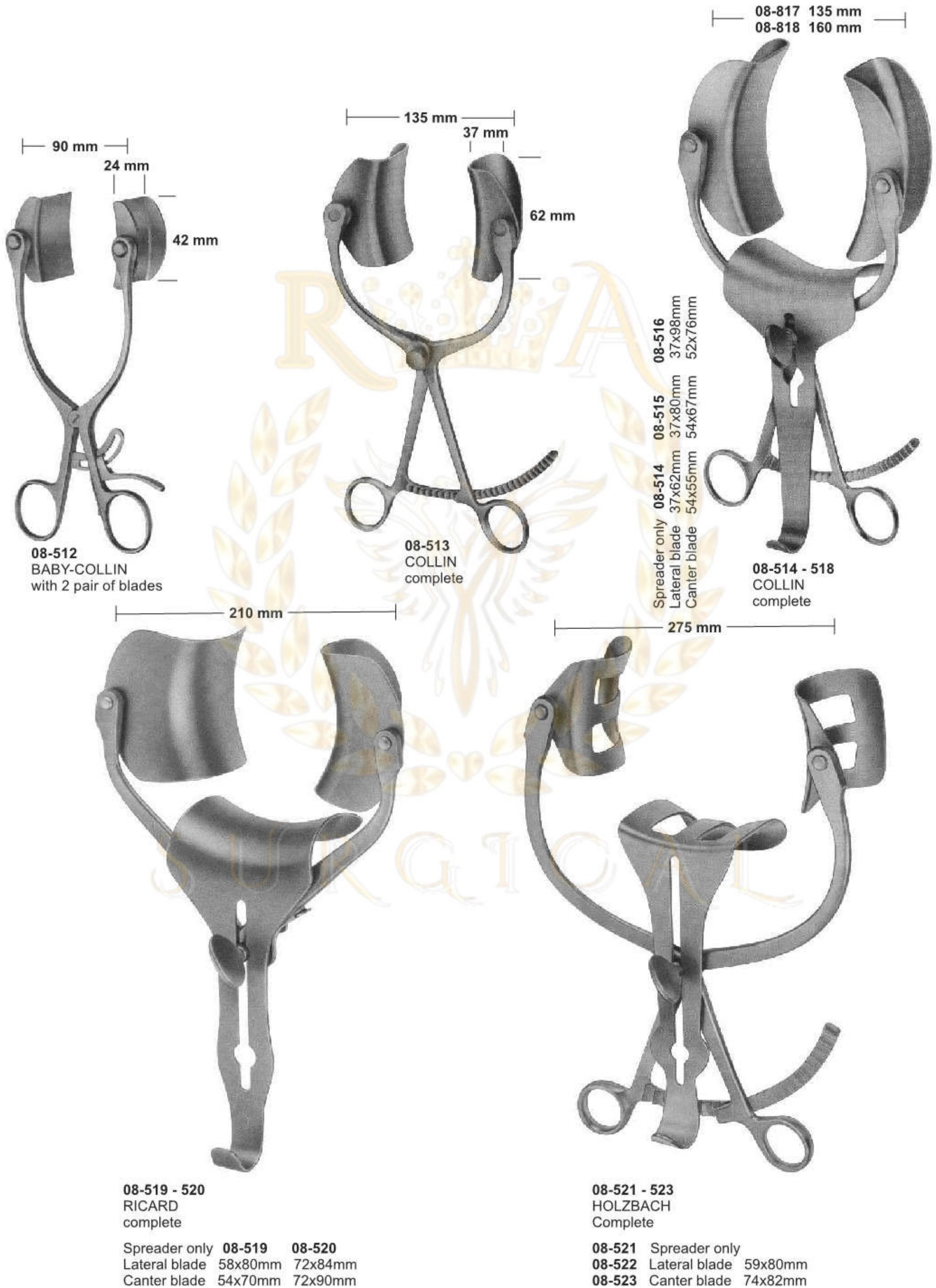

# Abdominal Baldes

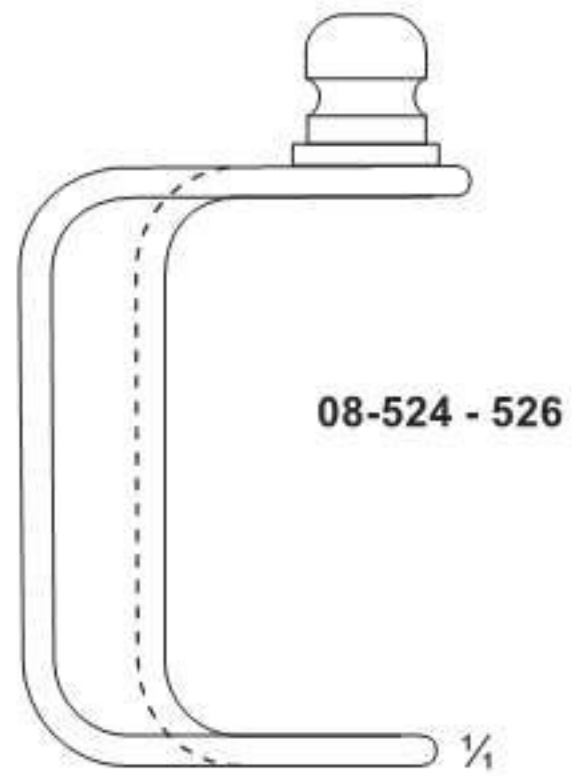

Lateral blades only  
**08-524** 37x62 mm  
**08-525** 37x80 mm  
**08-526** 37x98 mm

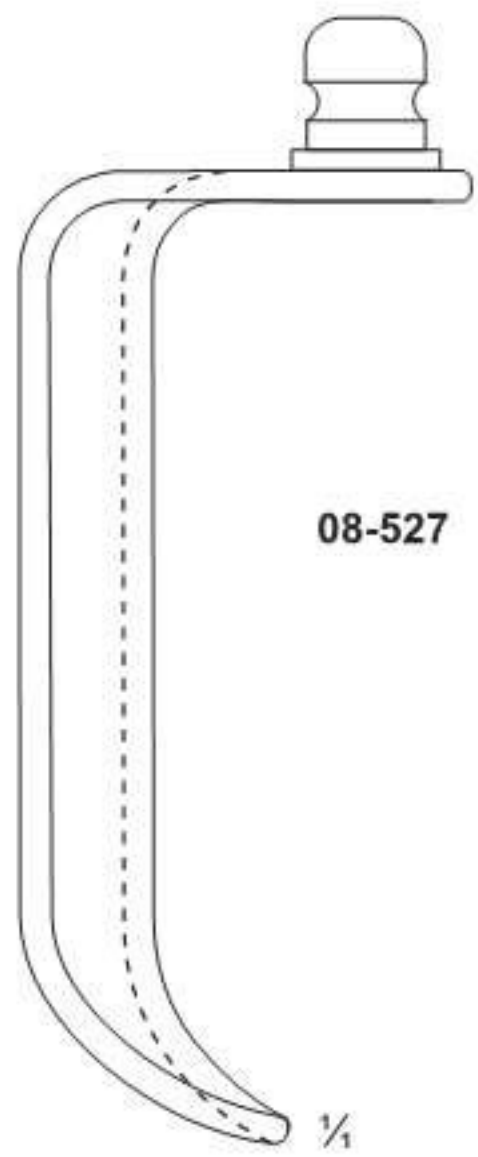

**08-527** 61x80 mm

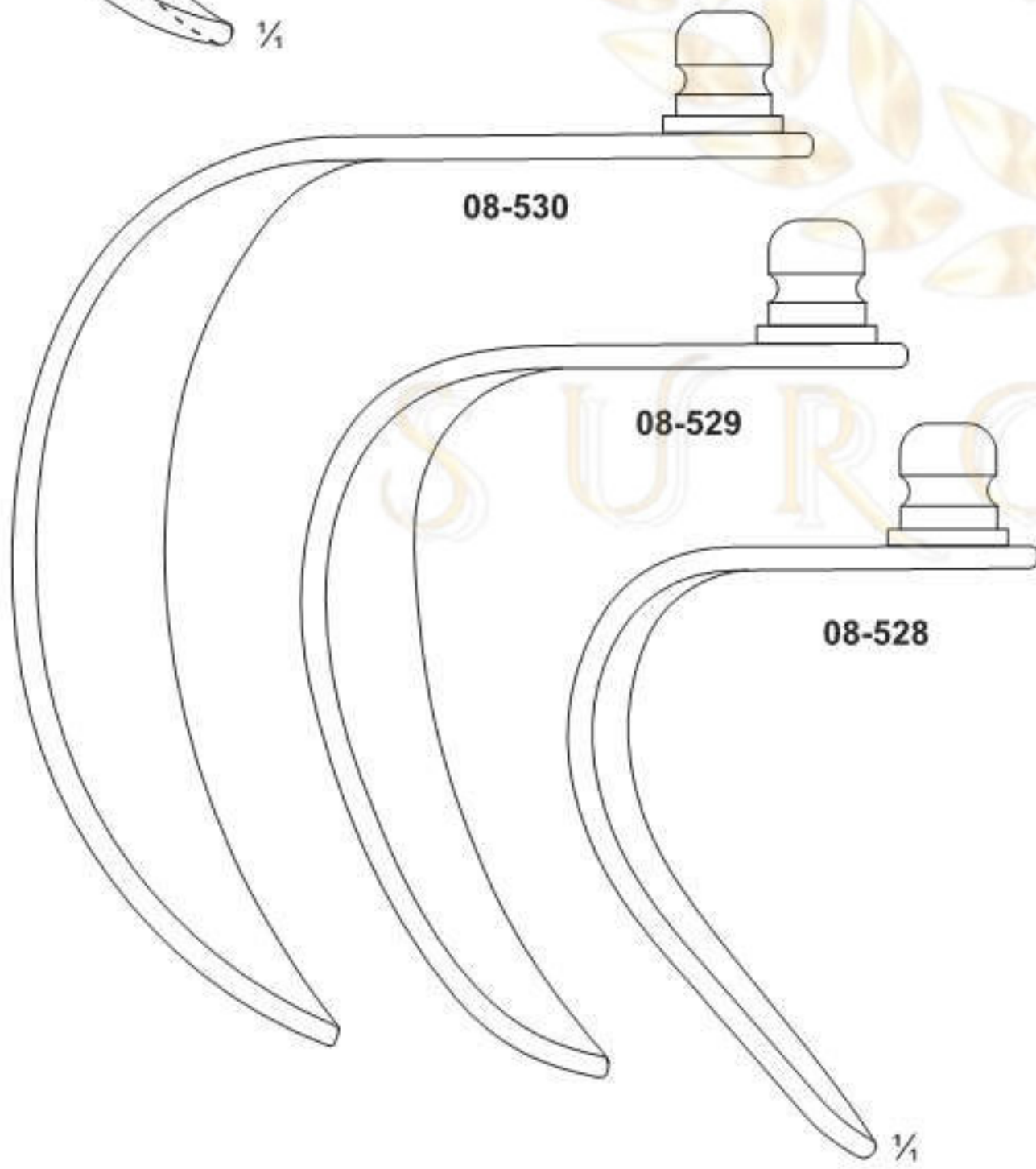

**08-528** 48x59 mm  
**08-529** 58x80 mm  
**08-530** 72x84 mm

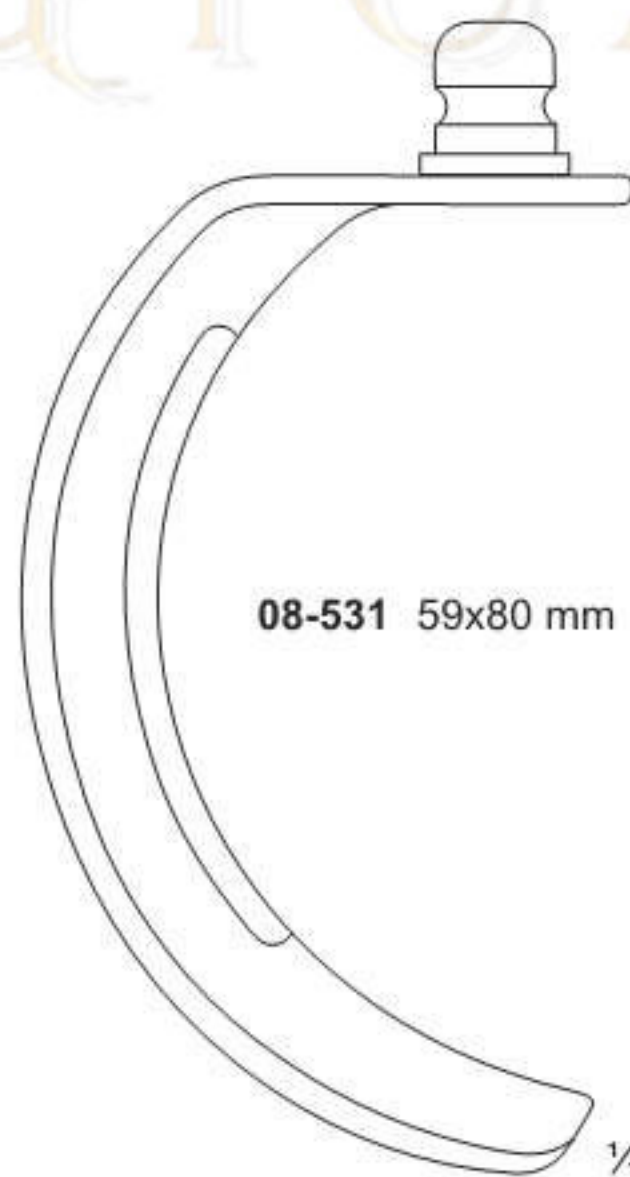

**08-531** 59x80 mm



# Abdominal Retractors



**08-532**  
GOSSET  
Blades:38 mm deep

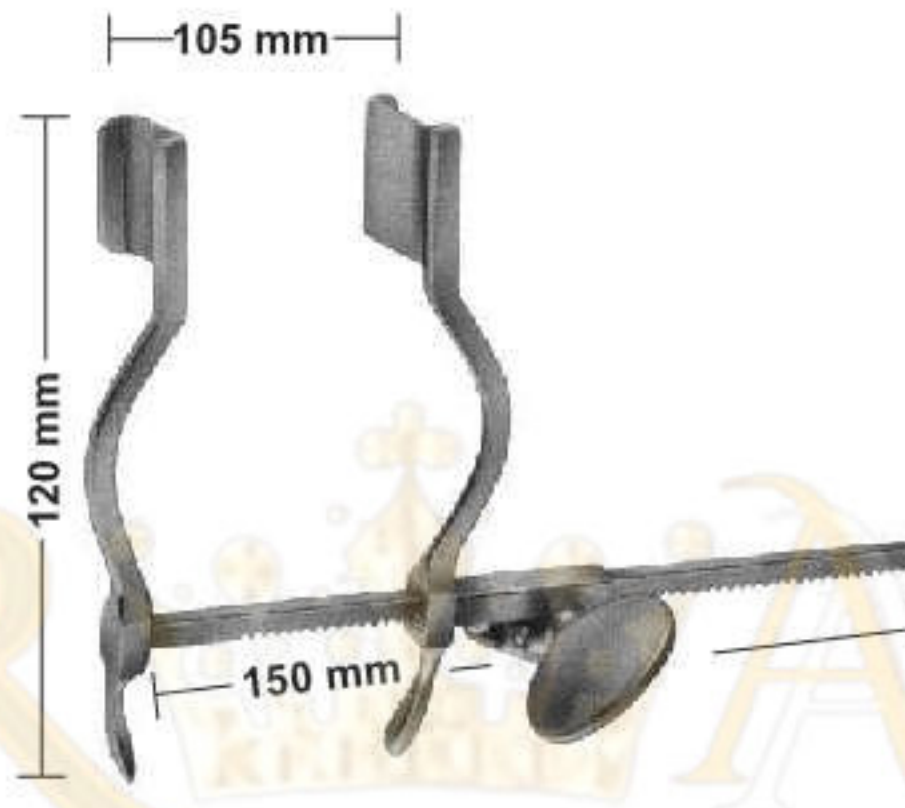

**08-533**  
HERTZLER  
Blades 20 X 25 mm

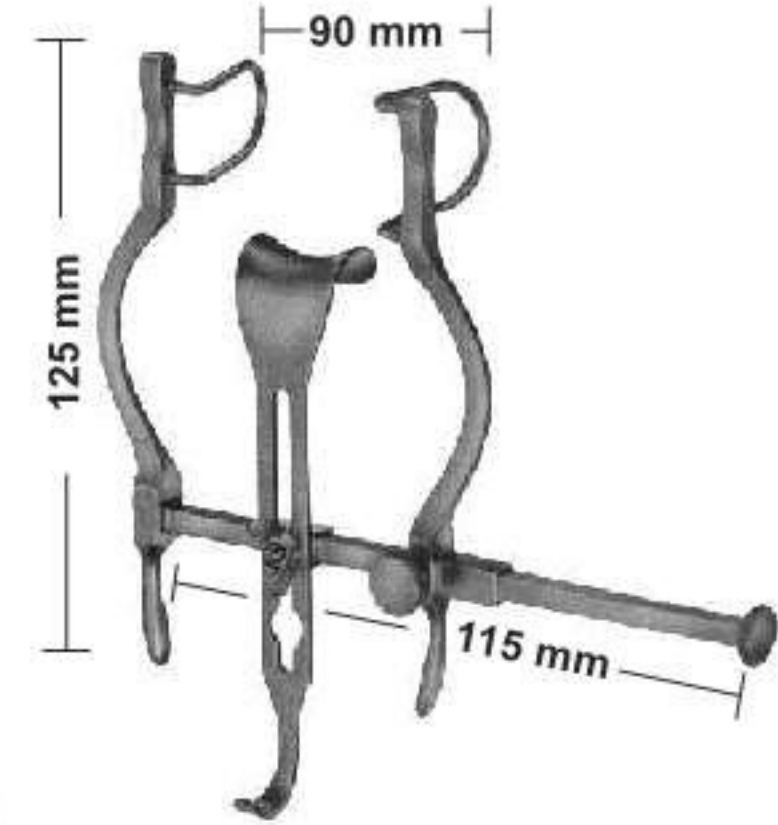

**08-534**  
BALFOUR-BABY  
Lateral blades 27 mm deep  
Center blade 21x24 mm



**08-535**  
GOSSET  
Blades:55mm deep

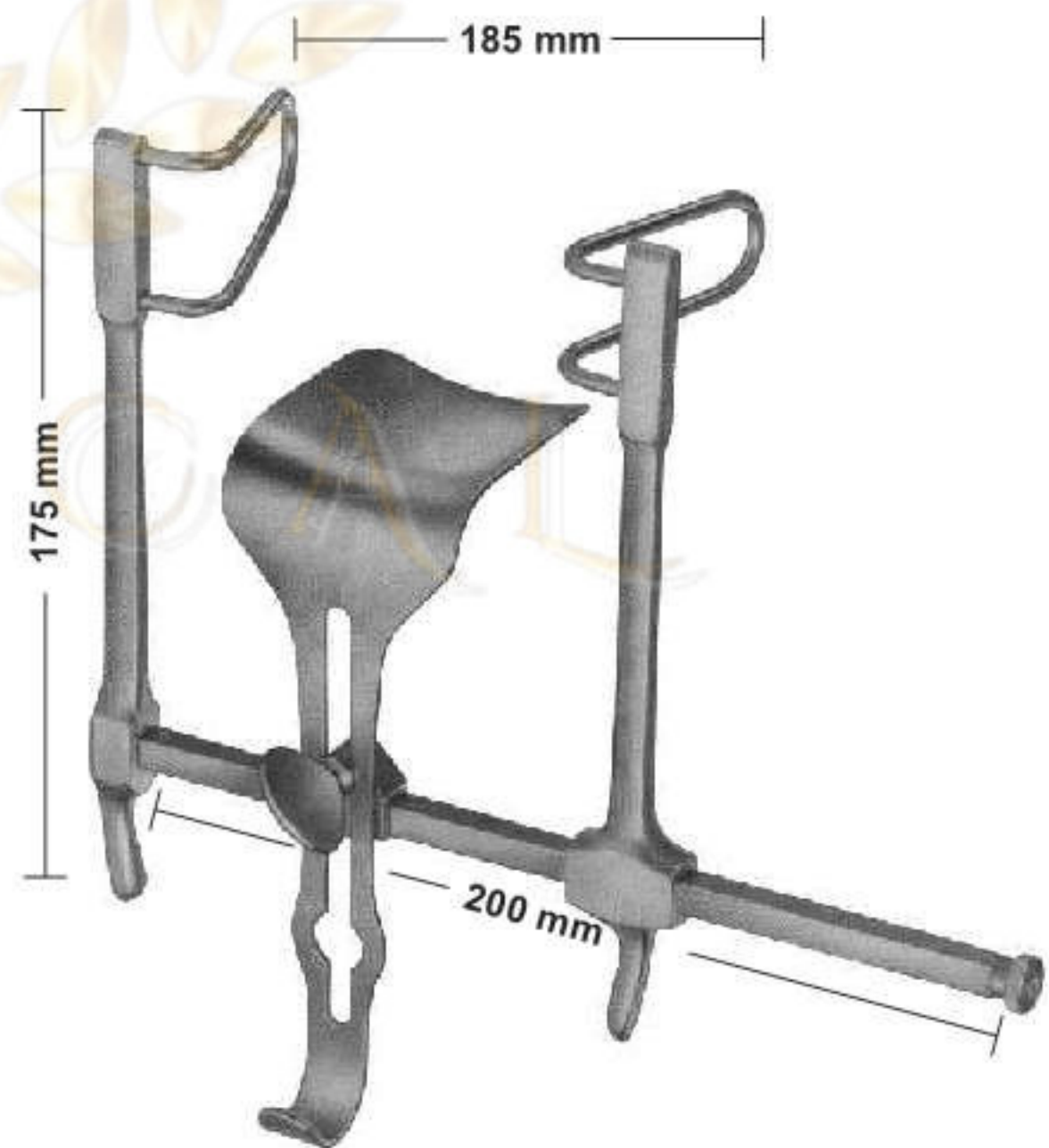

**08-536**  
GOSSET  
Lateral blades 58 mm deep  
Center blade 59 x 57 mm

# Abdominal Retractors

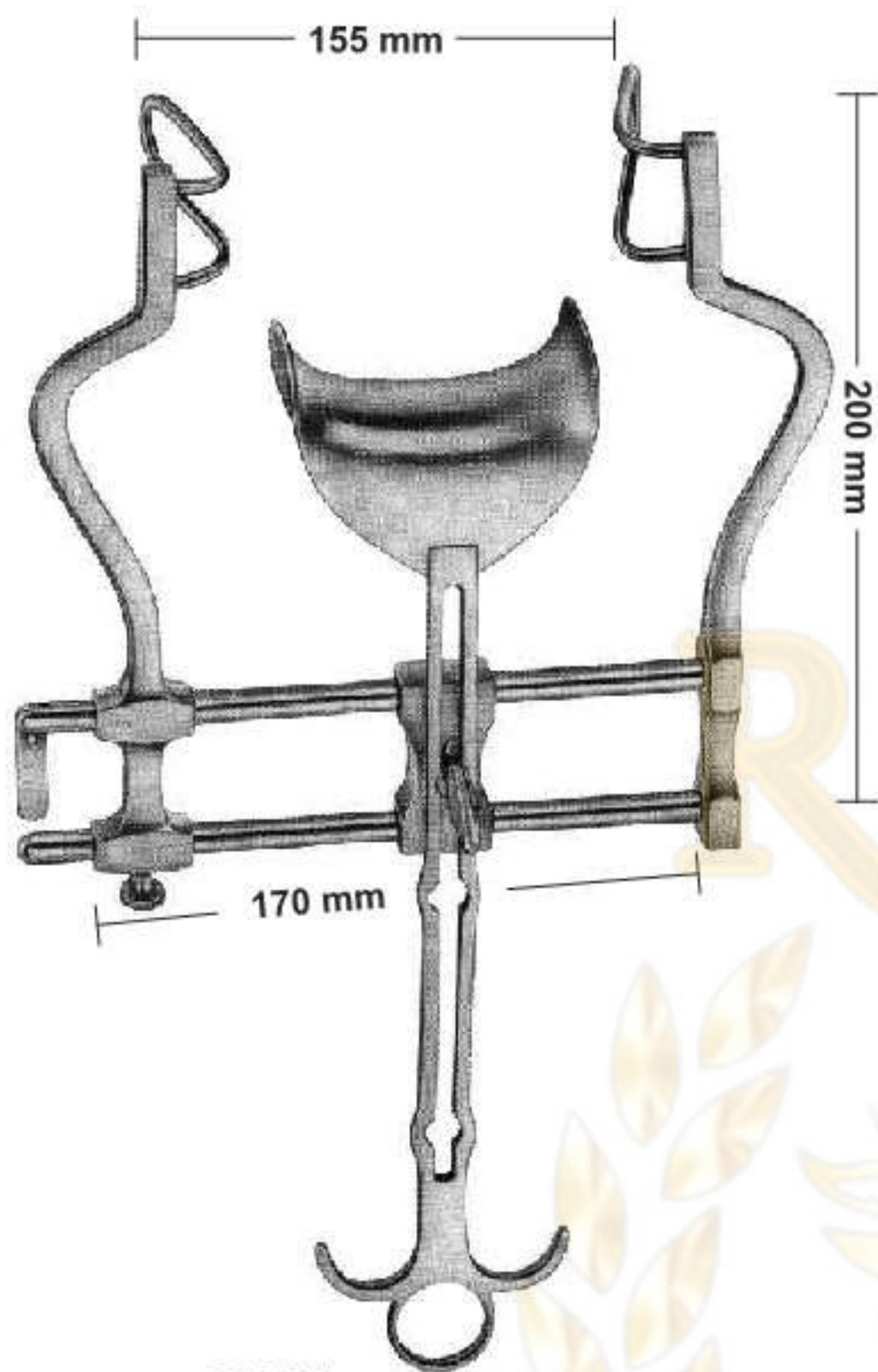

**08-537**  
BALFOUR  
Lateral blades 60 mm deep  
Center blade 47 x 80 mm

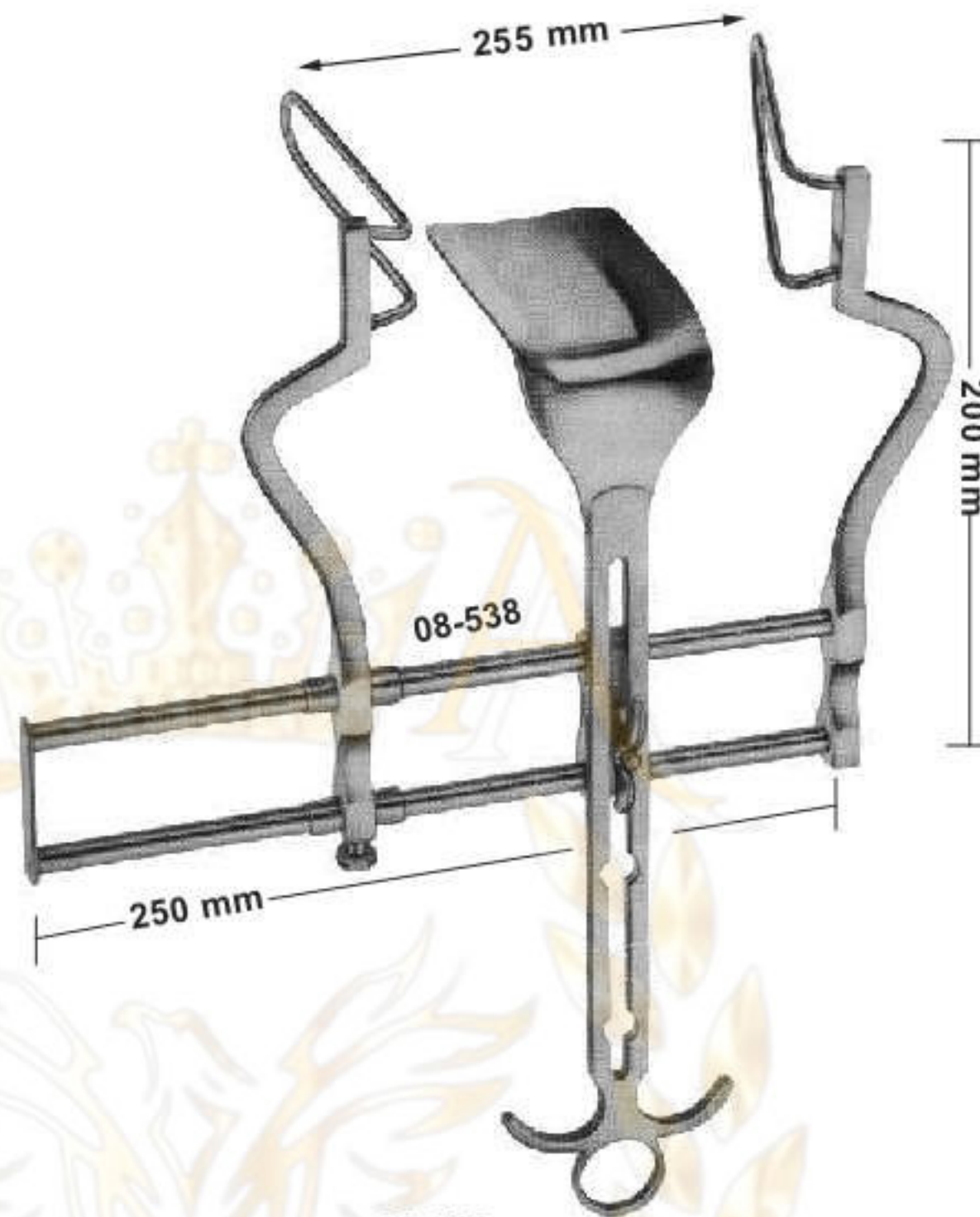

**08-538**  
BALFOUR  
Lateral blades 105 mm deep  
Center blade 107x 59 mm



**08-539**  
Center blade only  
54x80 mm

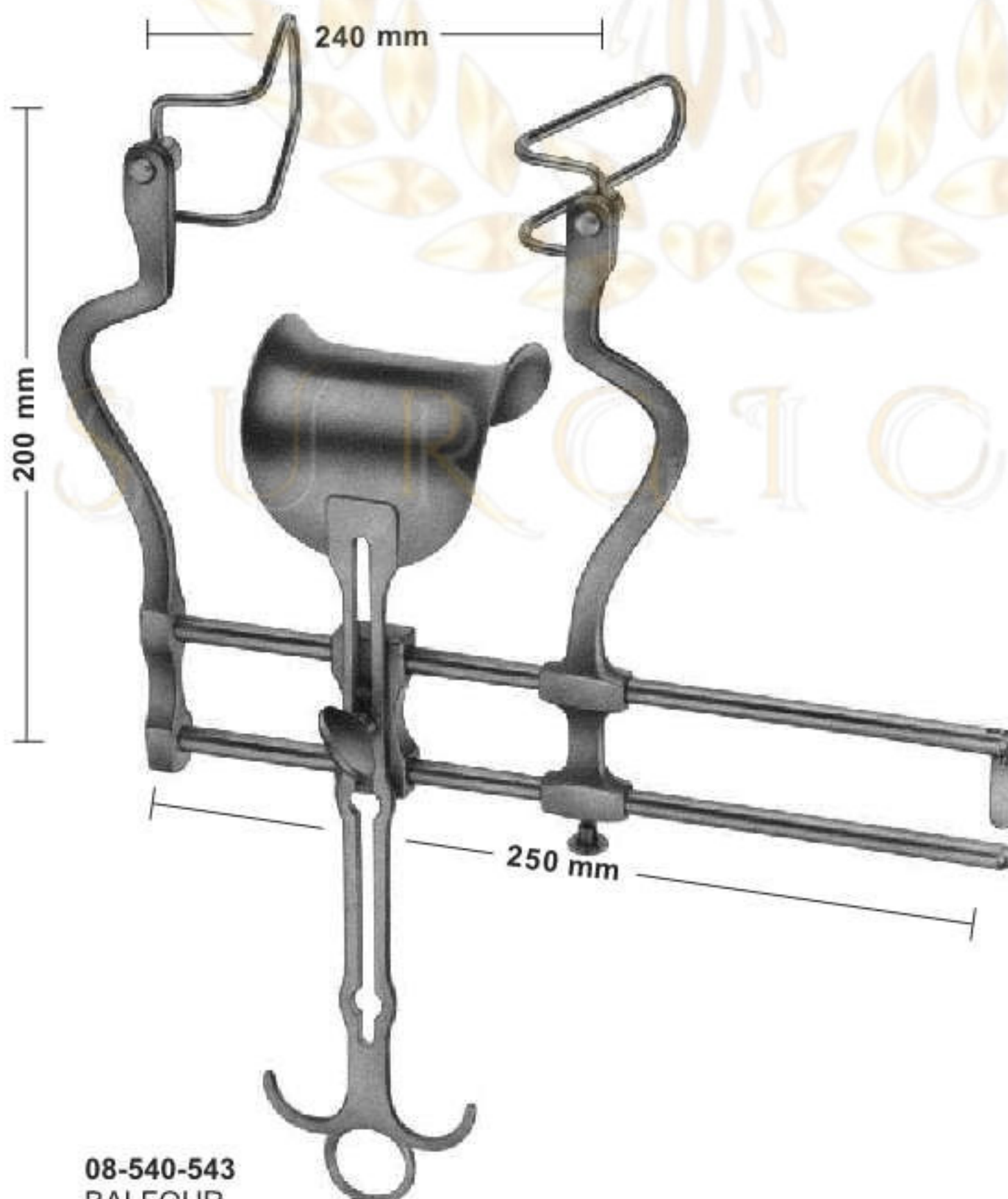

**08-540-543**  
BALFOUR  
Spreader only  
Lateral blades 50 mm 08-540 60 mm 08-541 75 mm 08-542 90 mm 08-543  
Center blade 47 x 80 mm 62x76 mm 80x80 mm 80x80 mm



Sales Unit of blades: PR = pair

Lateral blades  
**08-544** 50 mm deep  
**08-545** 60 mm deep  
**08-546** 75 mm deep  
**08-547** 90 mm deep

# Abdominal Retractors

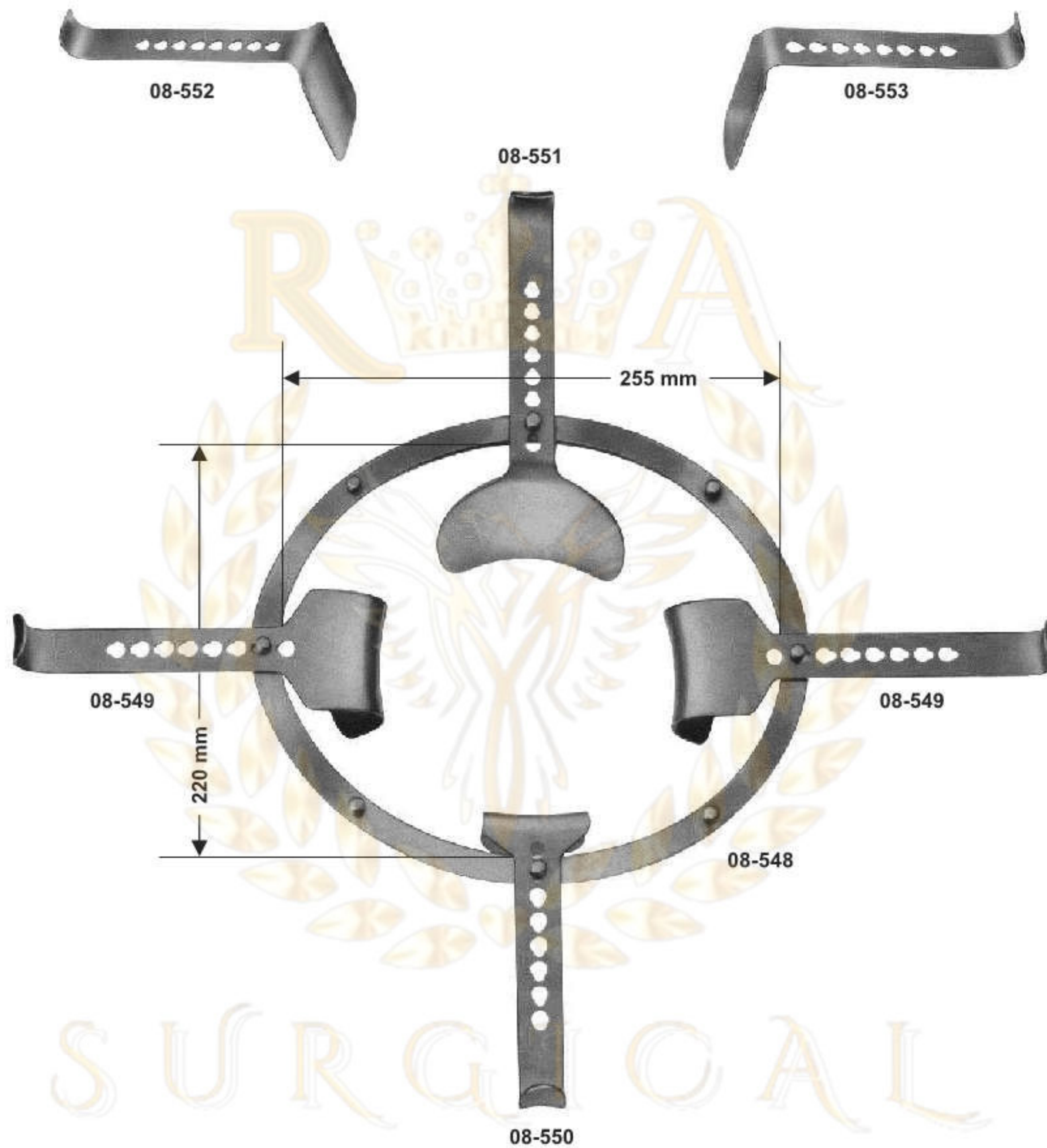

## 08-548 - 08-553

SEMM

consisting of:

- 08-548 1 frame 225 x 220 mm
- 08-549 2 blades 46 x 64 mm
- 08-550 1 blade 53 x 54 mm  
(for bladder)
- 08-551 1 blade 82 x 97 mm  
(for intestine)
- 08-552 1 blade 98 x 51 mm  
(for intestine)
- 08-553 1 blade, narrow  
107 x 36 mm

# Abdominal Retractors

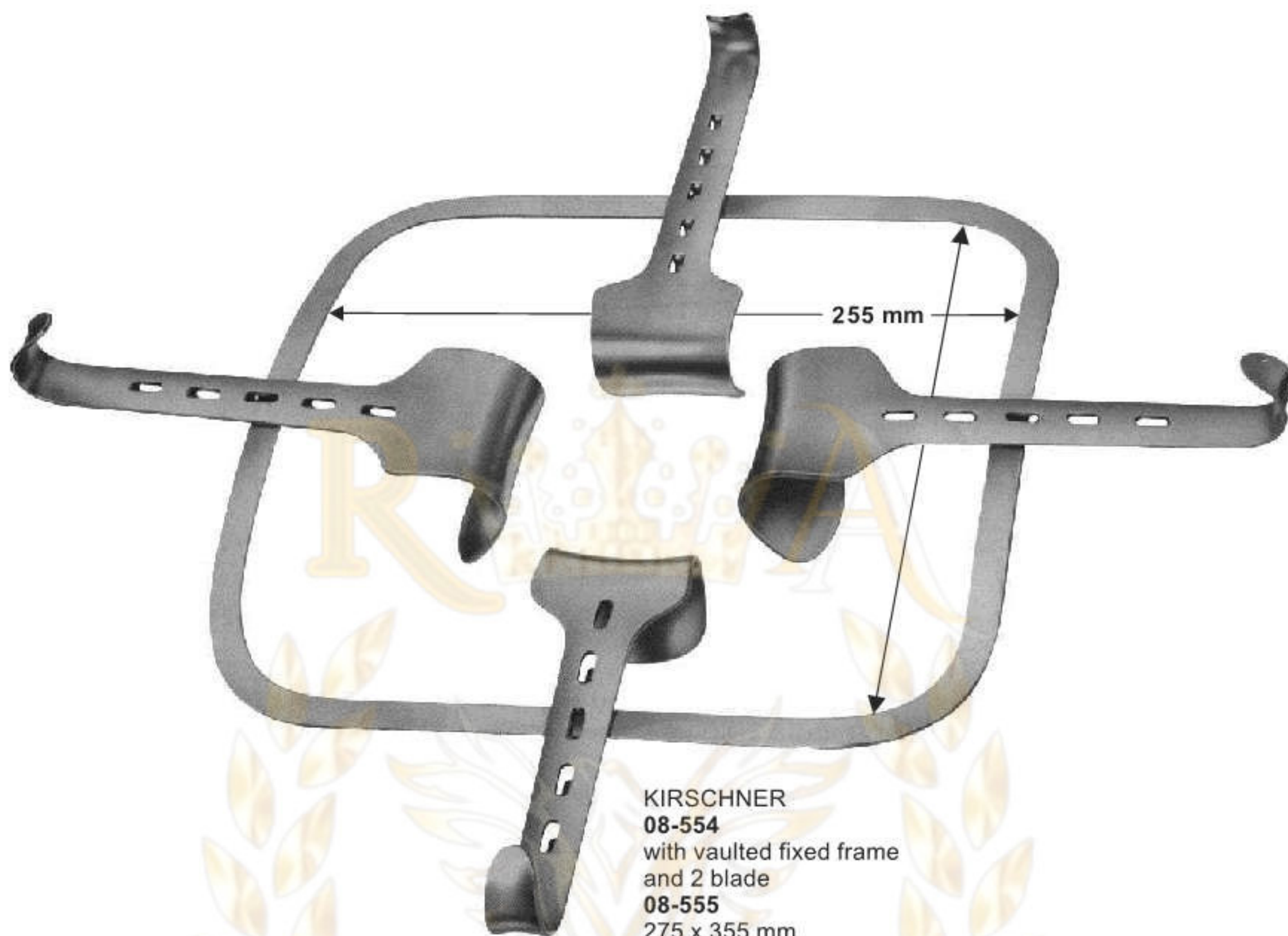

**KIRSCHNER**  
**08-554**  
 with vaulted fixed frame  
 and 2 blade  
**08-555**  
 275 x 355 mm  
 Frame only, over-sized  
**08-556**  
 295 x 275 mm  
 Frame only



**08-557**  
**KIRSCHNER**  
 64 x 80 mm

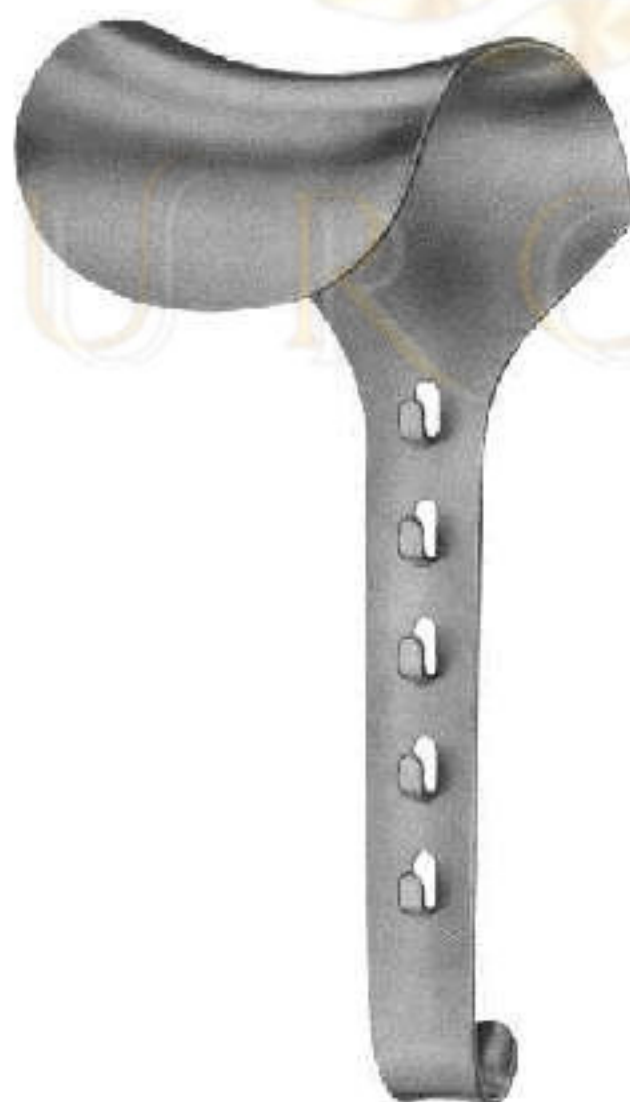

**08-558**  
**KIRSCHNER-BALFOUR**  
 80x 82 mm



**08-559 - 561**  
**KIRSCHNER**  
**08-559** 90x 69mm  
**08-560** 92x 95mm  
**08-561** 78x 58mm



**08-562 - 564**  
**KIRSCHNER**  
**08-562** 108x42mm  
**08-563** 91x 55mm  
**08-564** 121x 55mm

# Intestinal and Tissue Grasping Forceps

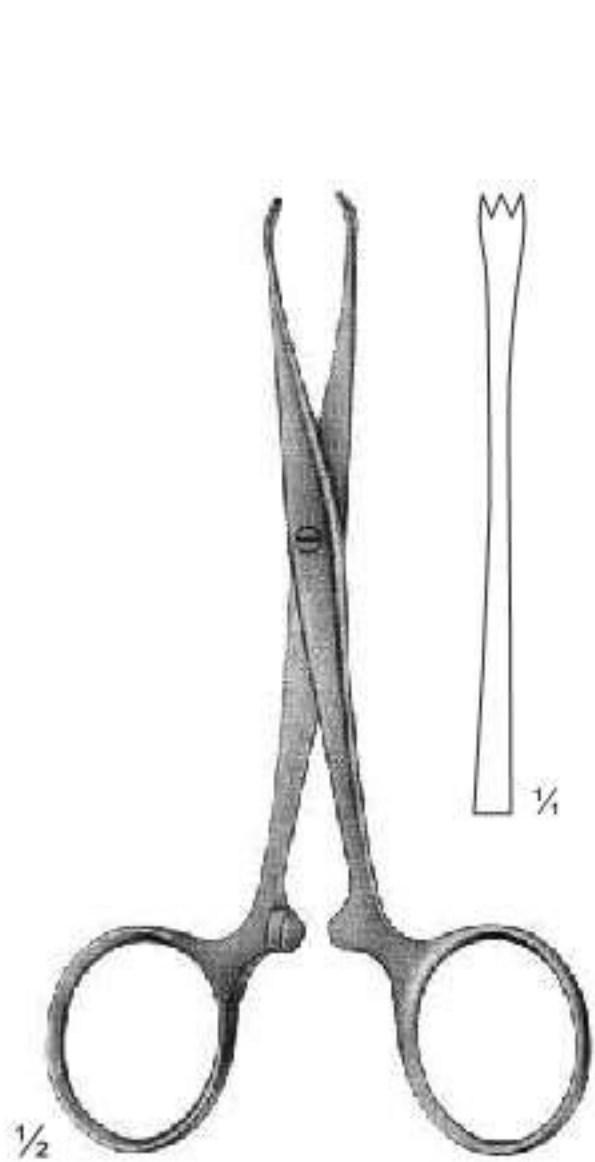

**09-101**  
**CHAPUT**  
 2 X 3 teeth, sharp  
 125 mm,

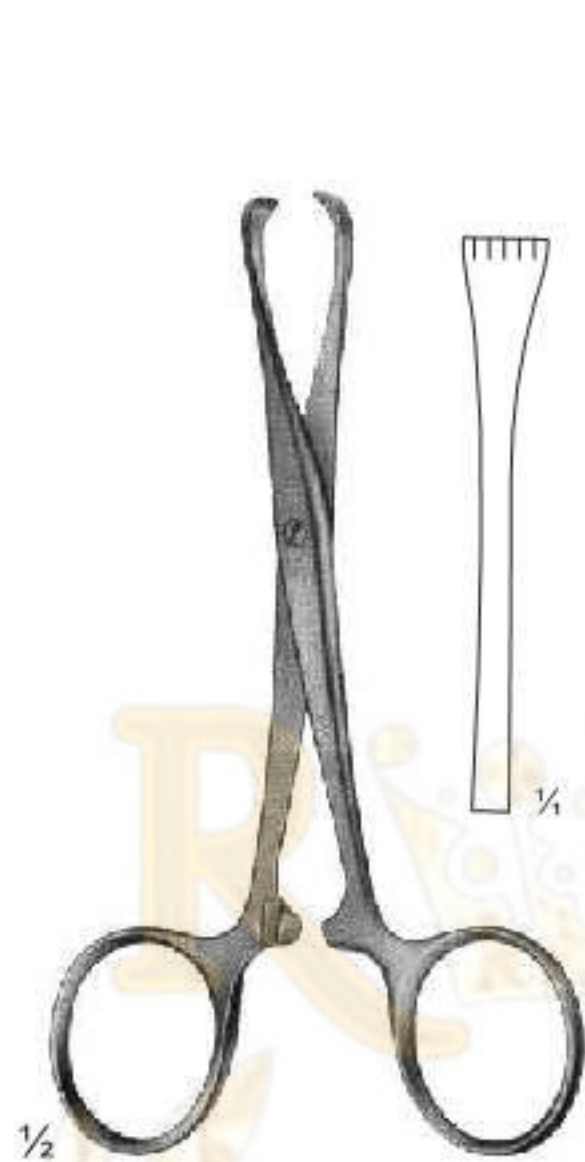

**09-102**  
**TUFFIER**  
 5 X 6 teeth, sharp  
 125 mm,



**09-103**  
**BOYS-ALLIS**  
 5 X 6 teeth, sharp  
 155 mm,

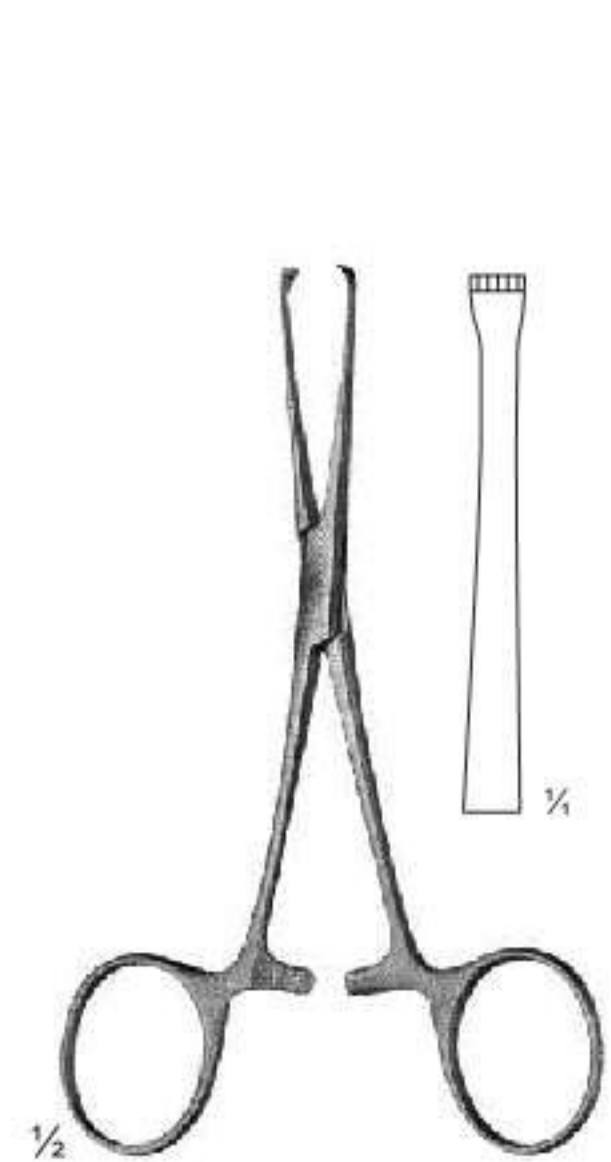

**09-104**  
**ALLIS**  
 4 X 5 teeth  
 155 mm,

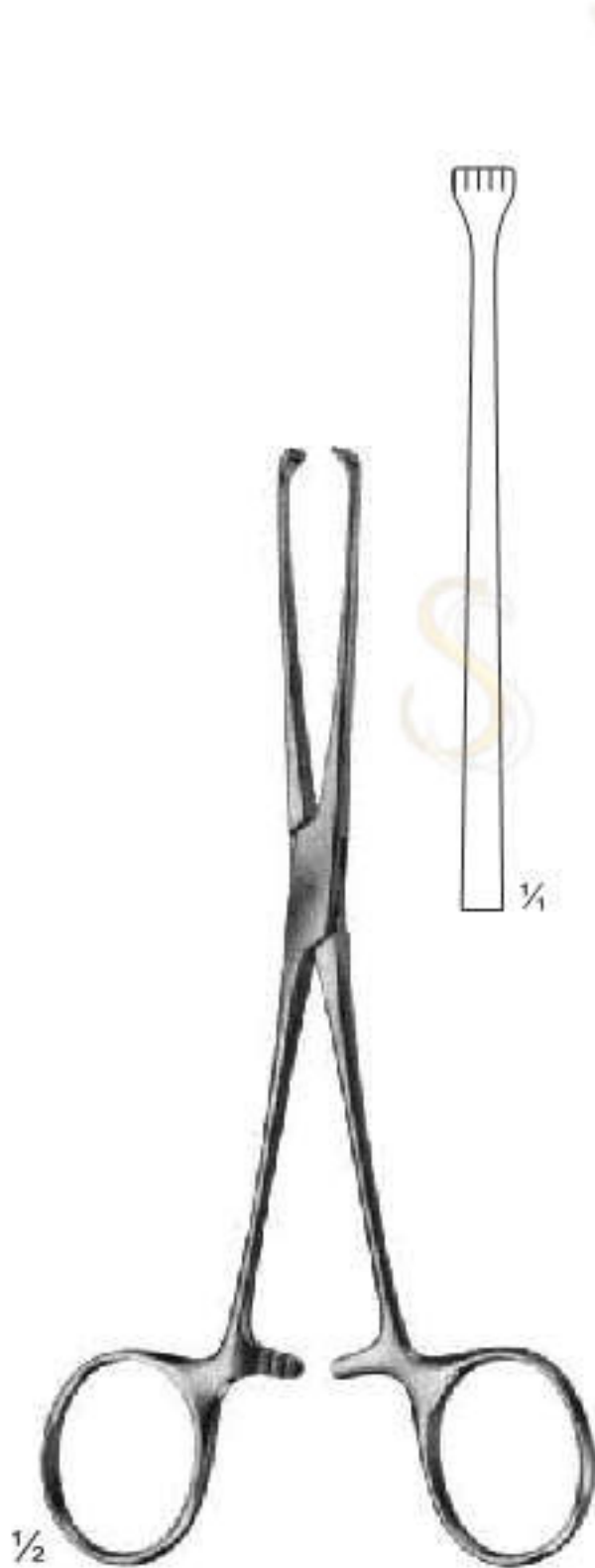

**09-105**  
**ALLIS**  
 155 mm,  
 4 X 5 teeth

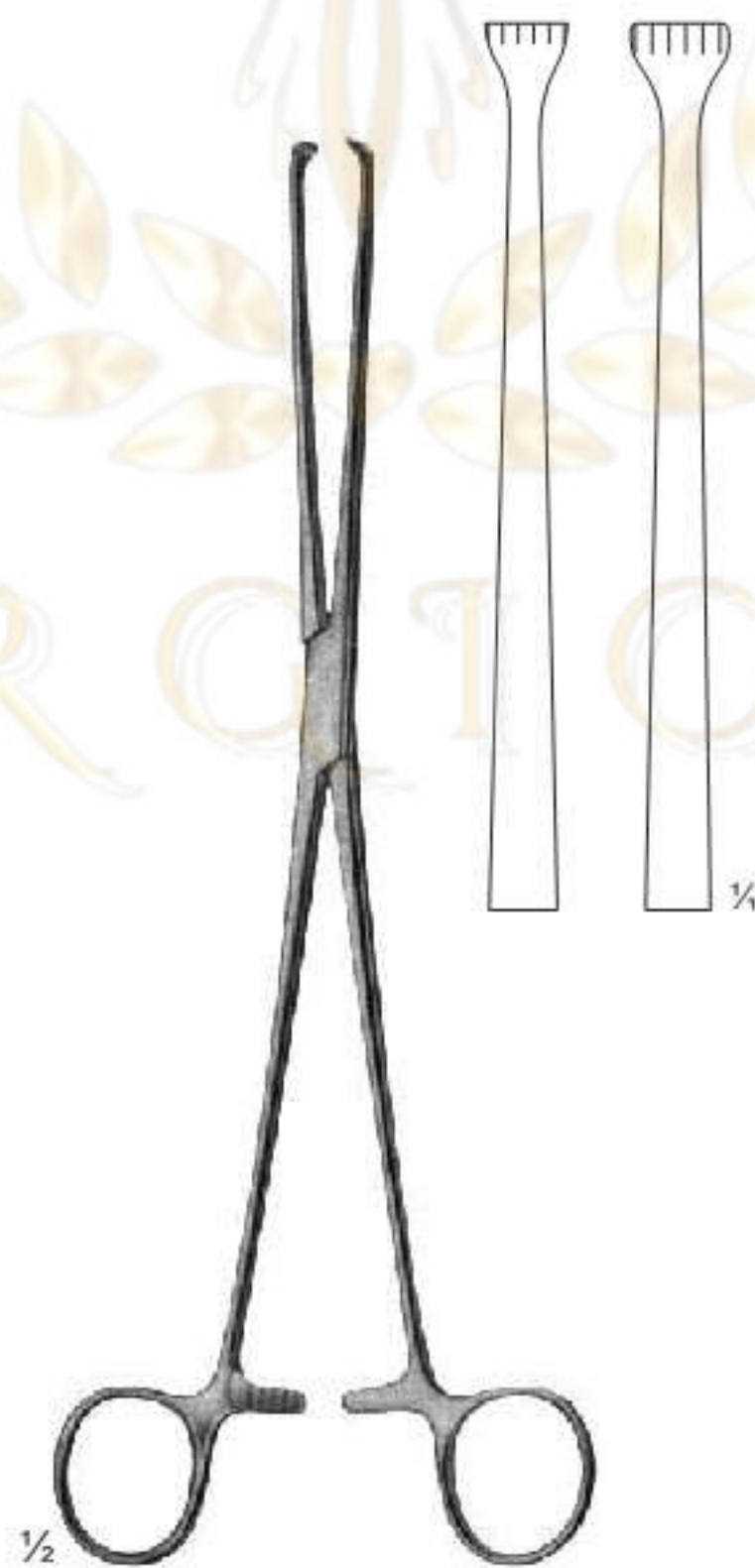

**09-106**  
**ALLIS**  
 190 mm,  
**09-107**  
 255 mm,  
 5 X 6 teeth



**09-108**  
**JUDD-ALLIS**  
 3 X 4 teeth  
 195 mm,

# Intestinal Grasping Forceps





# Organ - Tissue Grasping, Dissecting & Intestinal Forceps



# Organ - Tissue Grasping, Dissecting & Intestinal Forceps



# Ultra - Light - Forceps, Dissecting Forceps

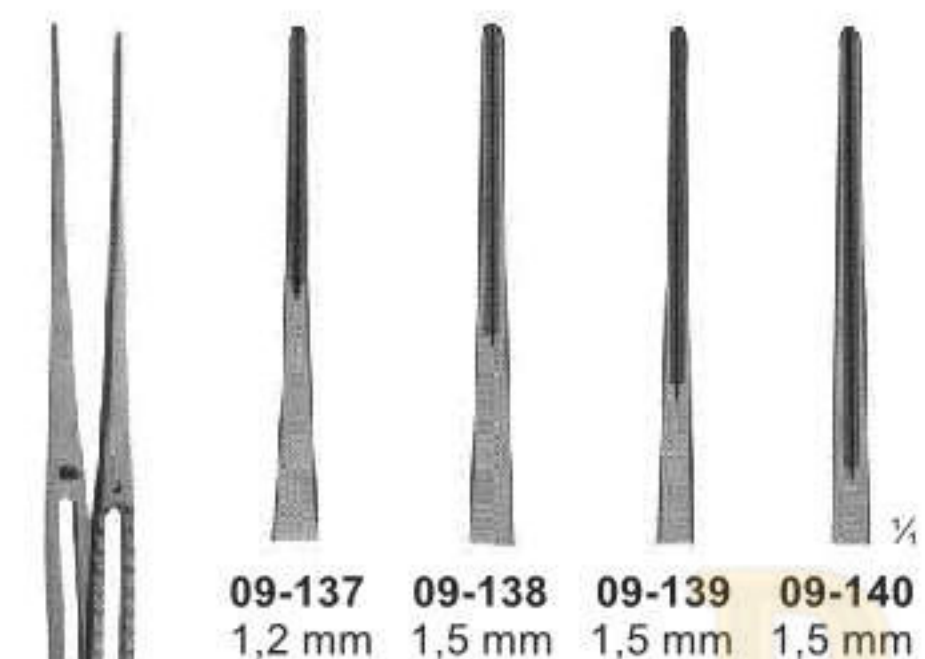

09-137 150 mm  
 09-138 200 mm  
 09-139 240 mm  
 09-140 300 mm

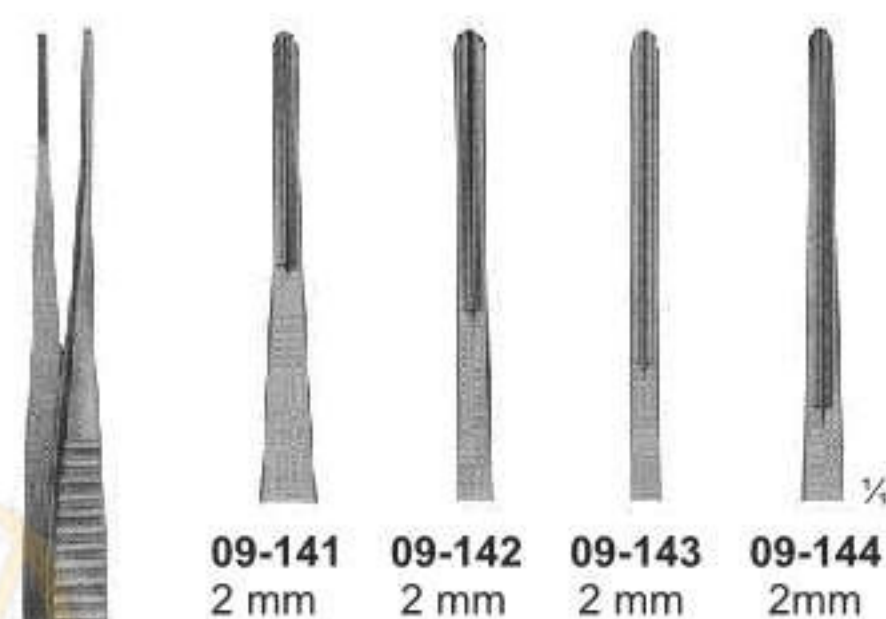

DE BAKEY  
 09-141 150 mm  
 09-142 200 mm  
 09-143 240 mm  
 09-144 300 mm

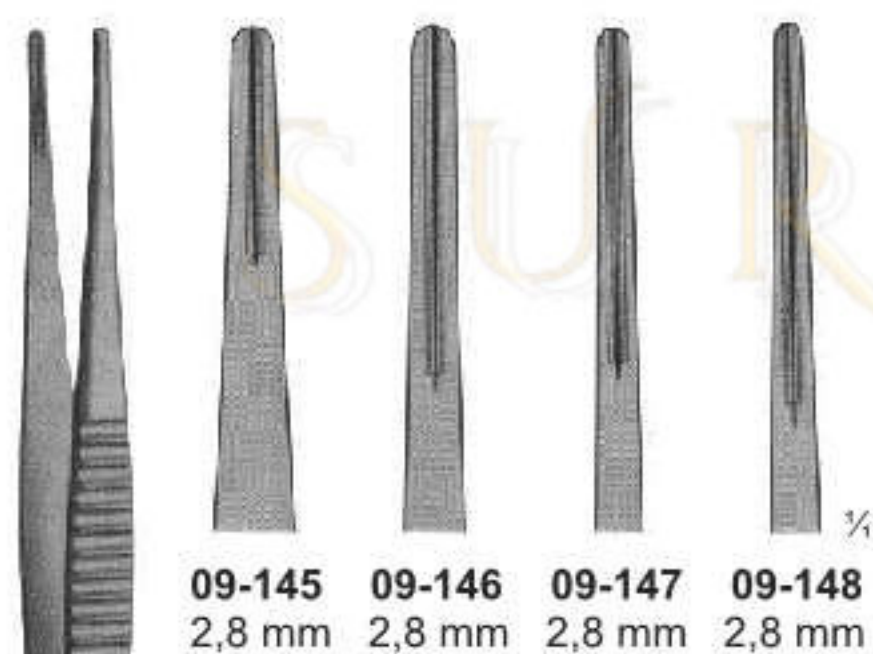

DE BAKEY  
 09-145 150 mm  
 09-146 200 mm  
 09-147 240 mm  
 09-148 300 mm

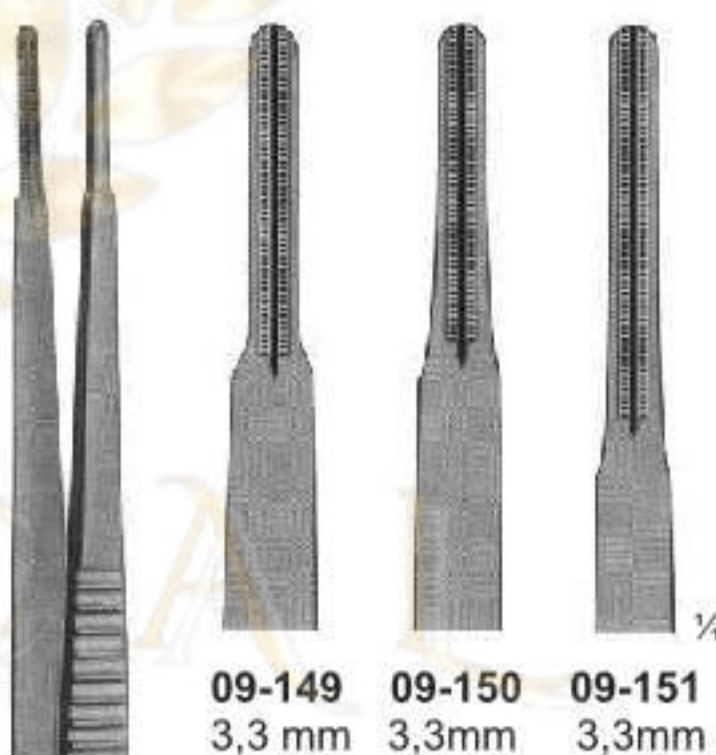

DE BAKEY  
 09-149 200 mm  
 09-150 240 mm  
 09-151 300 mm

# Intestinal Clamps for Children



09-152



09-153

09-152 - 153  
BAINBRIDGE  
155 mm



09-154

09-154  
ALLEN  
155 mm

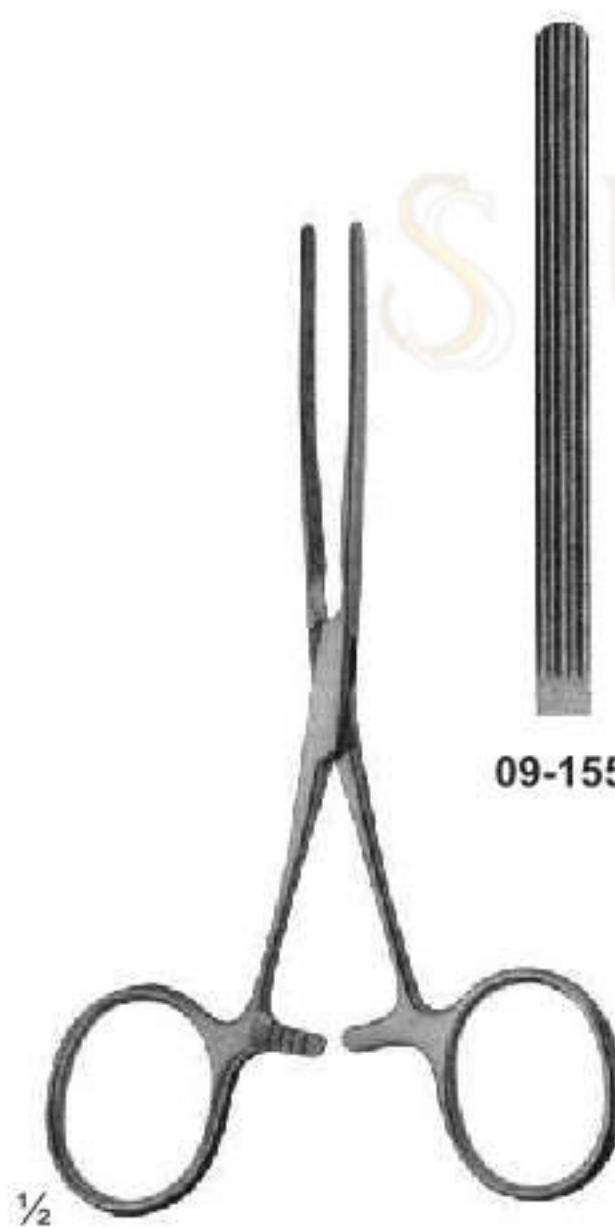

09-155



09-156

09-155 - 156  
BABY-KOCHER  
very elastic blades  
130 mm



09-157



09-158

09-157 - 158  
BABY-KOCHER  
with elastic blades  
130 mm

# Intestinal Clamps, Soft Elastic



# Intestinal Clamps, Soft elastic

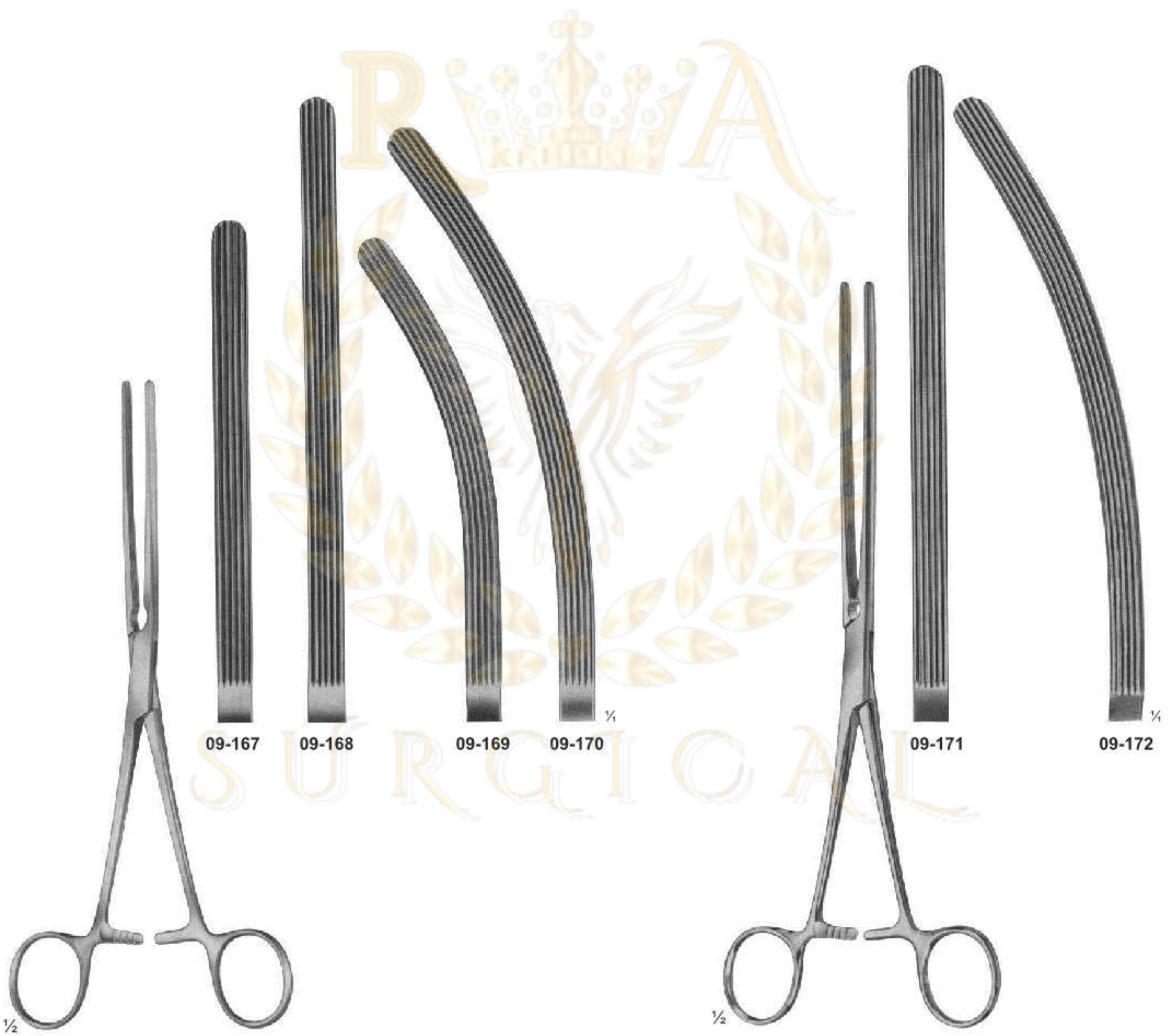

**09-167 - 170**  
KOCHER  
with elastic blades  
**09-169** 210 mm  
**09-170** 230 mm

**09-171 - 172**  
DOYEN  
with elastic blades  
210 mm

# Intestinal Clamps, Soft elastic



**09-173 - 174**  
DOYEN  
with elastic blades  
235 mm



**09-173**

**09-174**



**09-175 - 176**  
DOYEN  
with elastic blades  
230 mm



**09-175**

**09-176**

# Intestinal Clamps, Soft elastic

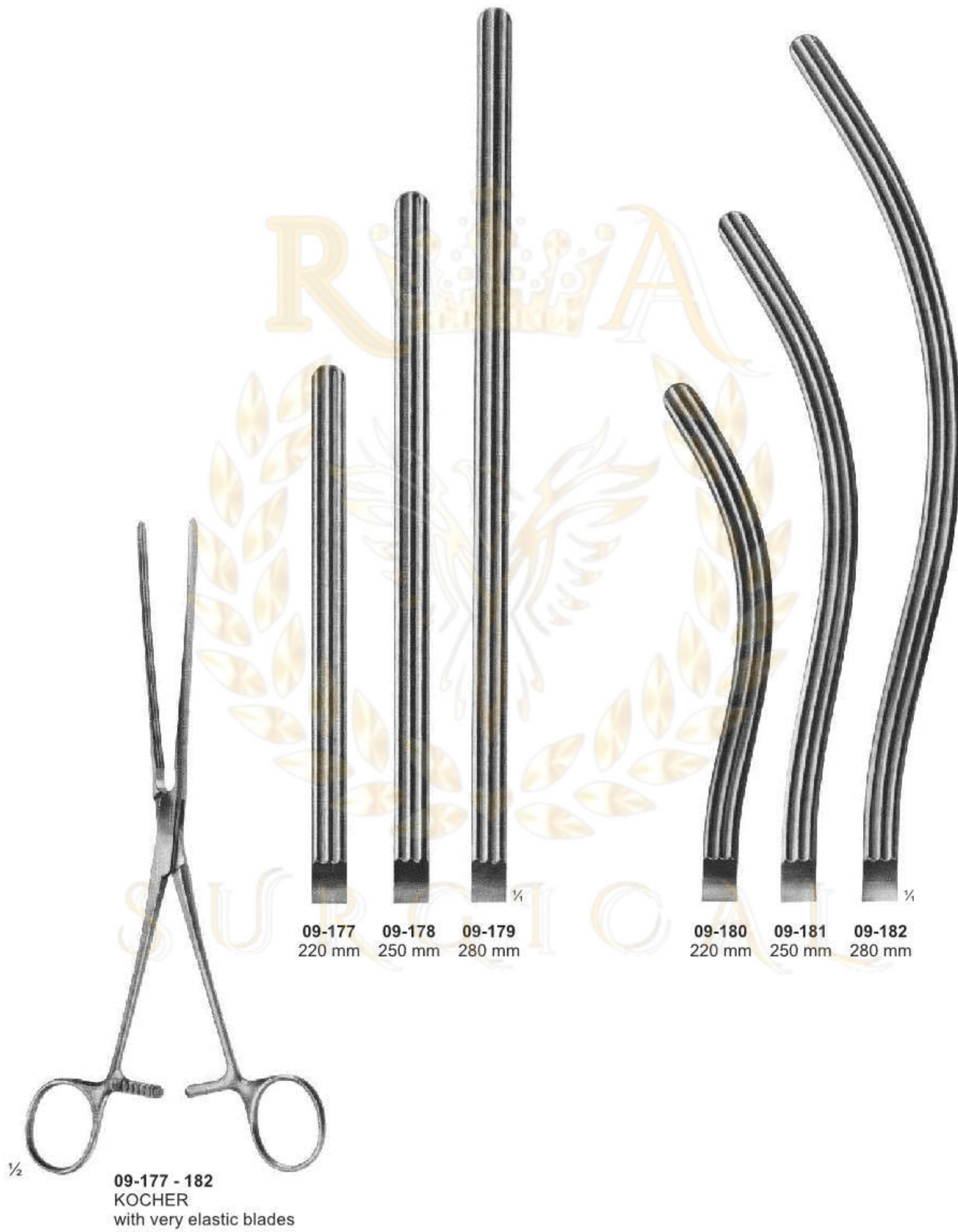



# Intestinal Clamps, Soft elastic

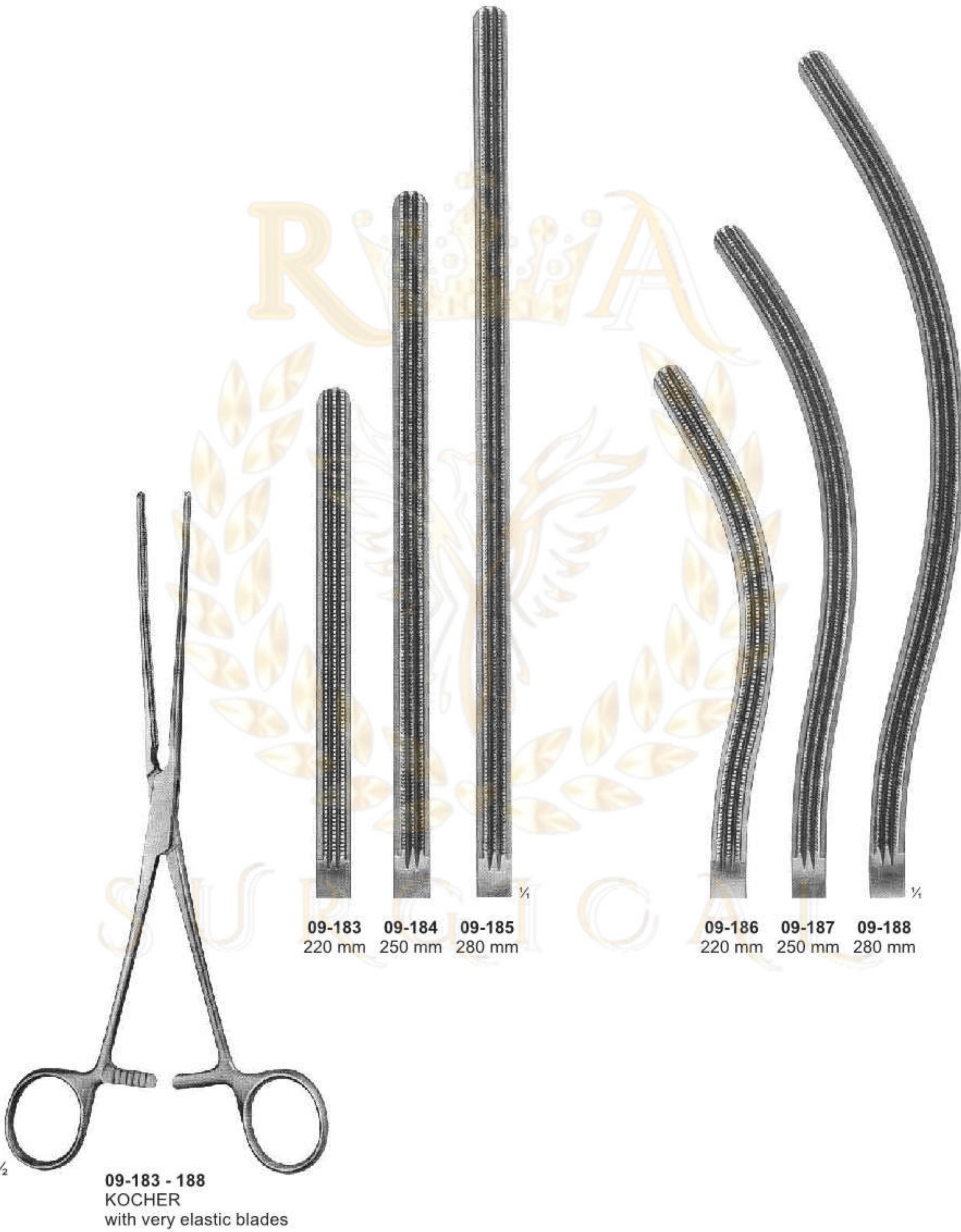

# Intestinal Clamps



**09-189 - 190**  
NUSSBAUM  
with elastic blades  
250 mm

**09-191**  
MOYNIHAN  
280 mm

# Intestinal Clamps

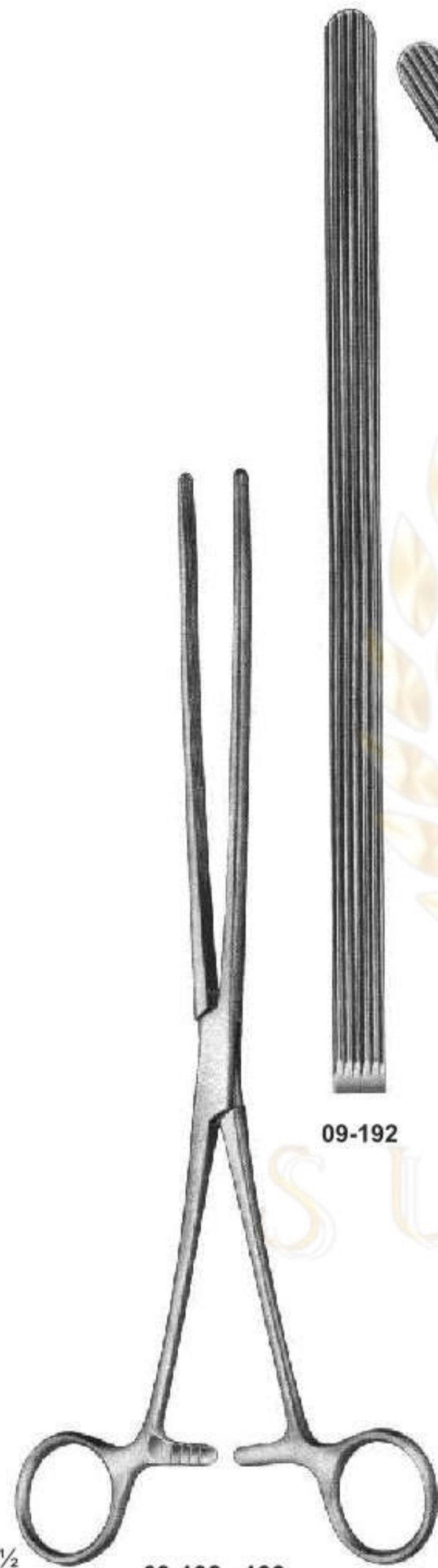

09-192 - 193  
MAYO-ROBSON  
hard elastic  
250 mm



09-192



09-193



09-194 - 195  
MAYO-ROBSON  
250 mm

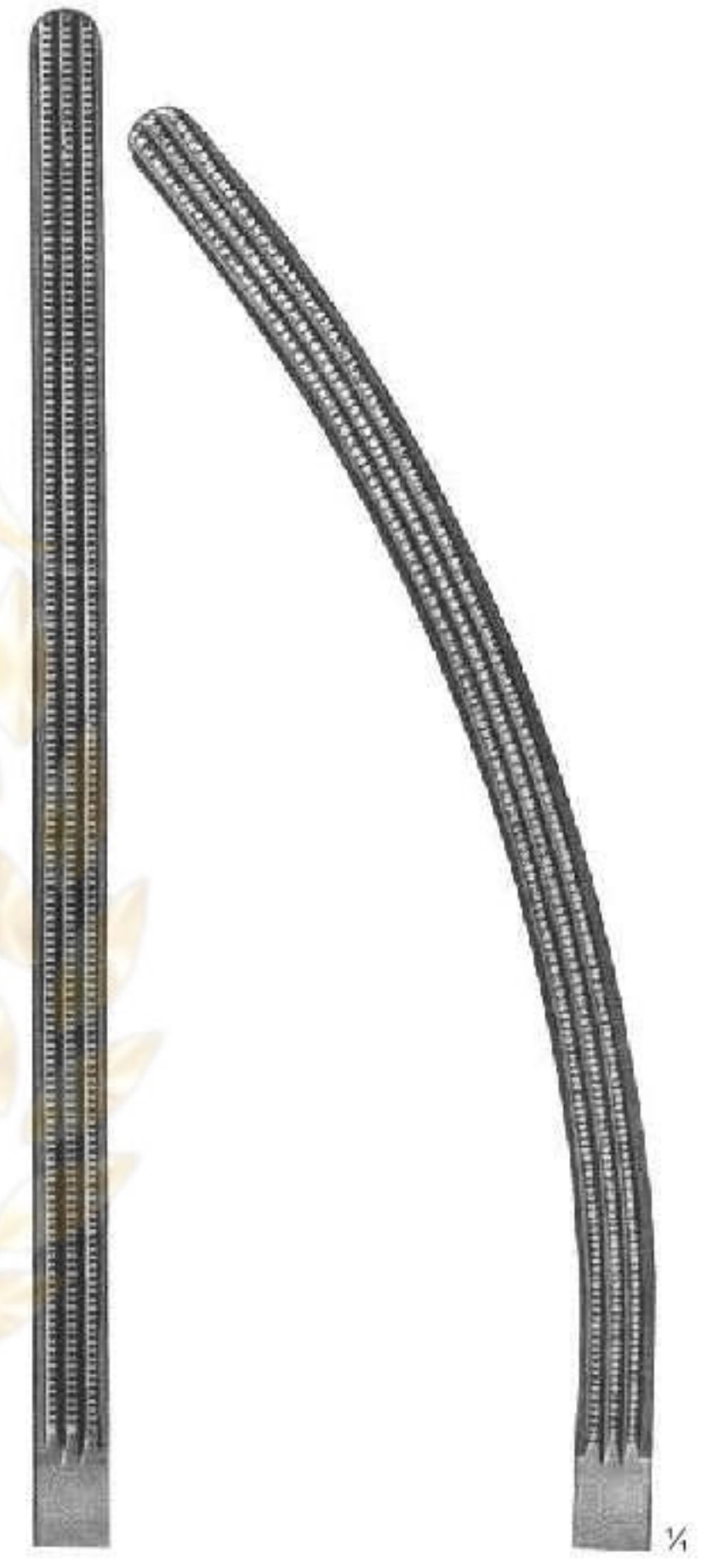

09-194



09-195

# Gastro-Intestinal Forceps, twin



09-196  
LANE  
300 mm

09-197  
LANE  
300 mm

# Stomach Clamps



09-198  $\frac{1}{4}$



09-199  $\frac{1}{4}$



$\frac{1}{2}$   
09-198 - 199  
SCUDDER  
330 mm



$\frac{1}{2}$   
09-200  
KLEINSCHMIDT  
Spur crushers and  
Appendectomy clamps  
130 mm

# Intestinal and Pylorus Clamps



**09-201**  
PAYR  
Intestinal clamp  
light pattern,  
for children  
180 mm

**09-202**  
PAYR  
200 mm

**09-203**  
PAYR  
275 mm

**09-204**  
PAYR  
Pylorus clamp  
315 mm

# Anastomosis Forceps

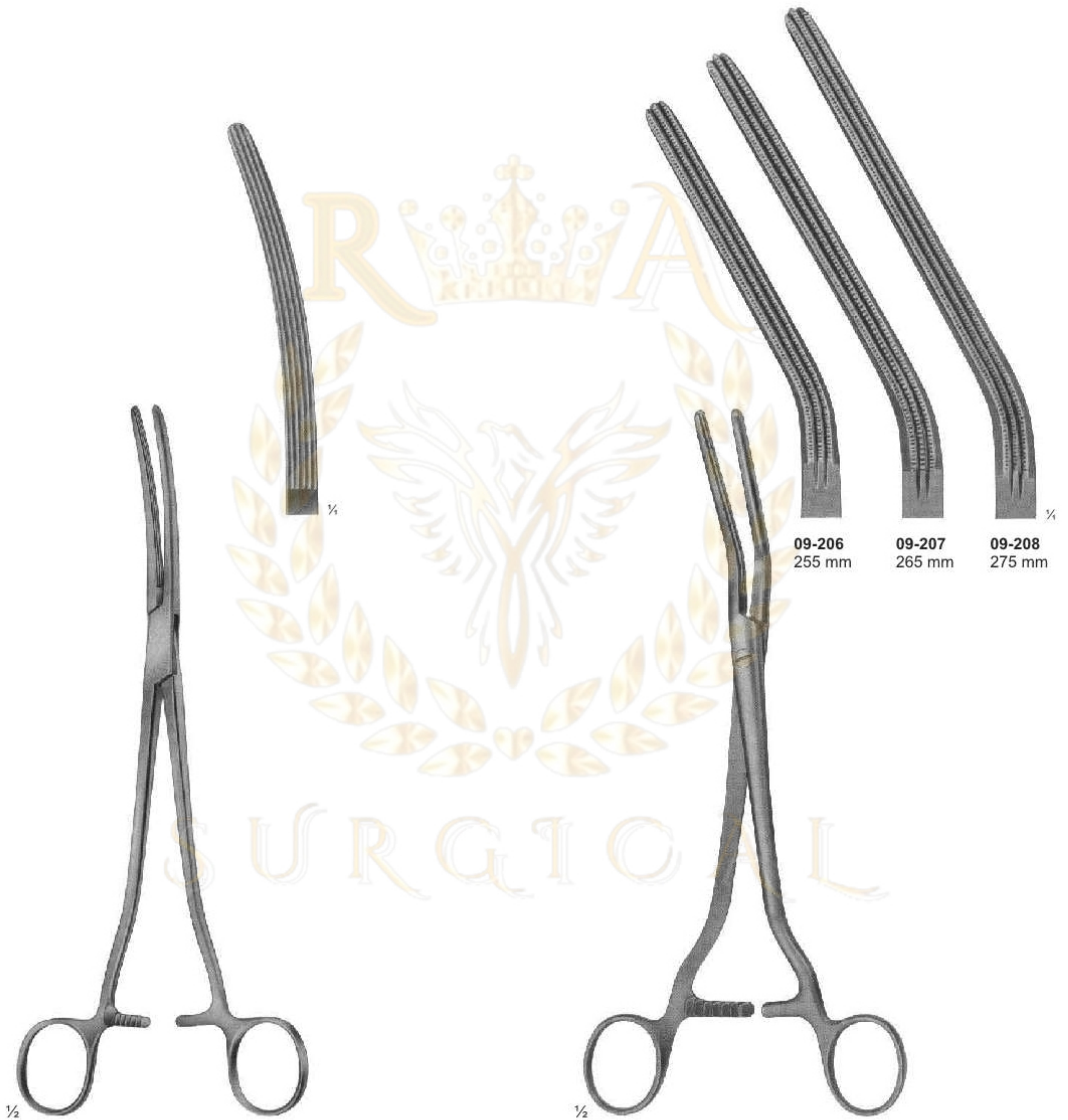

**09-205**  
PARKER-KERR  
anastomosis forceps  
for colon resection  
180 mm

**09-206 - 208**  
DICK  
pressure clamps  
180 mm

# Sigmoid Anastomosis Forceps





# Sigmoid Anastomosis Forceps

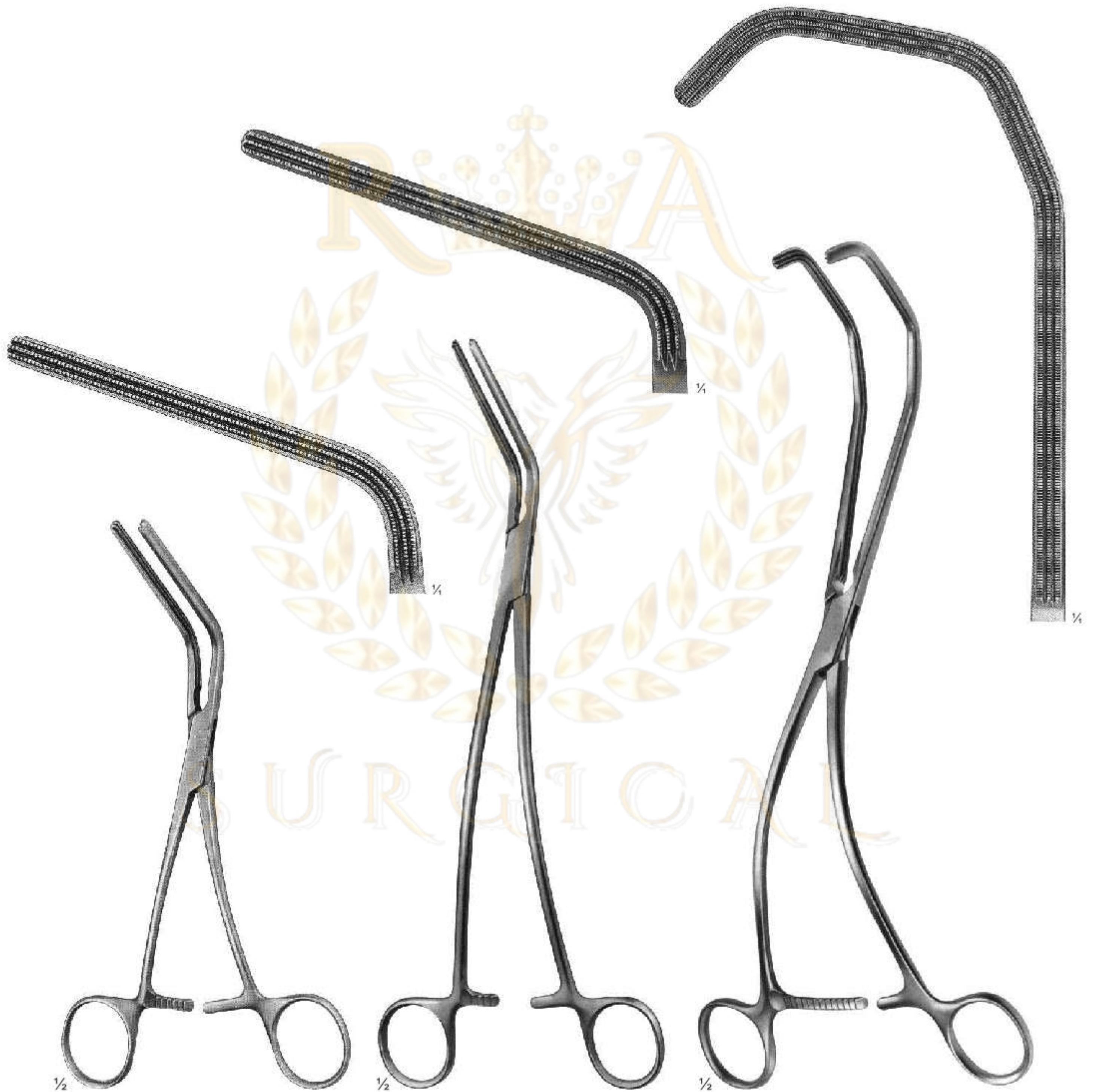

**09-212**  
MORRIS  
175 mm

**09-213**  
DE BAKEY  
(MORRIS modif.)  
240 mm

**09-214**  
KERSTING  
270 mm

# Rectal Specula

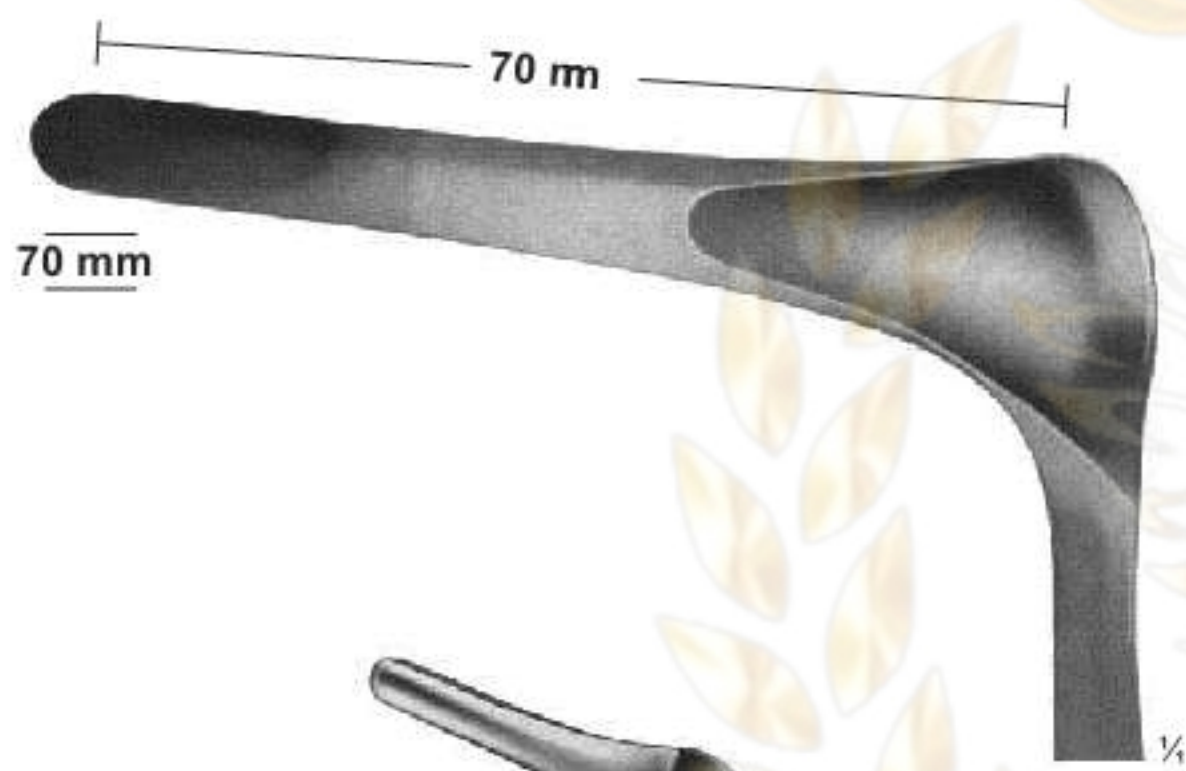

**10-101**  
KILLIAN  
for children  
145 mm



**10-102**  
SIMS  
160 mm



**10-103**  
SIMS  
160 mm

# Rectal Specula

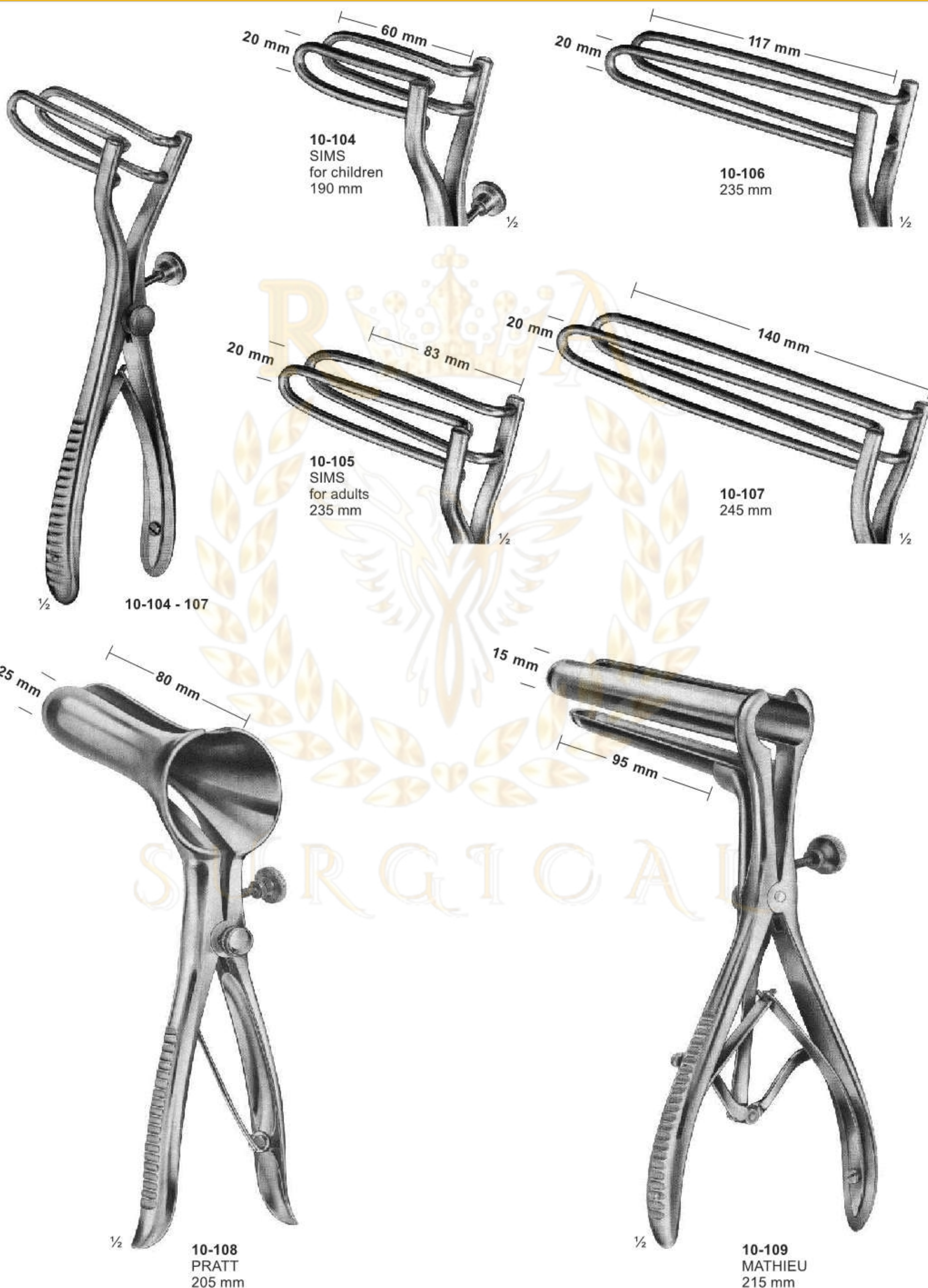

**10-104**  
SIMS  
for children  
190 mm

**10-106**  
235 mm

**10-105**  
SIMS  
for adults  
235 mm

**10-107**  
245 mm

**10-104 - 107**

**10-108**  
PRATT  
205 mm

**10-109**  
MATHIEU  
215 mm

# Anusopes-Sphincteroscopes



**10-110**  
IVES-FANSLER  
Anuscope  
145 mm



**10-111**  
KELLY  
Sphincteroscope  
160 mm



**10-112**  
KELLY  
Sphincteroscope  
160 mm

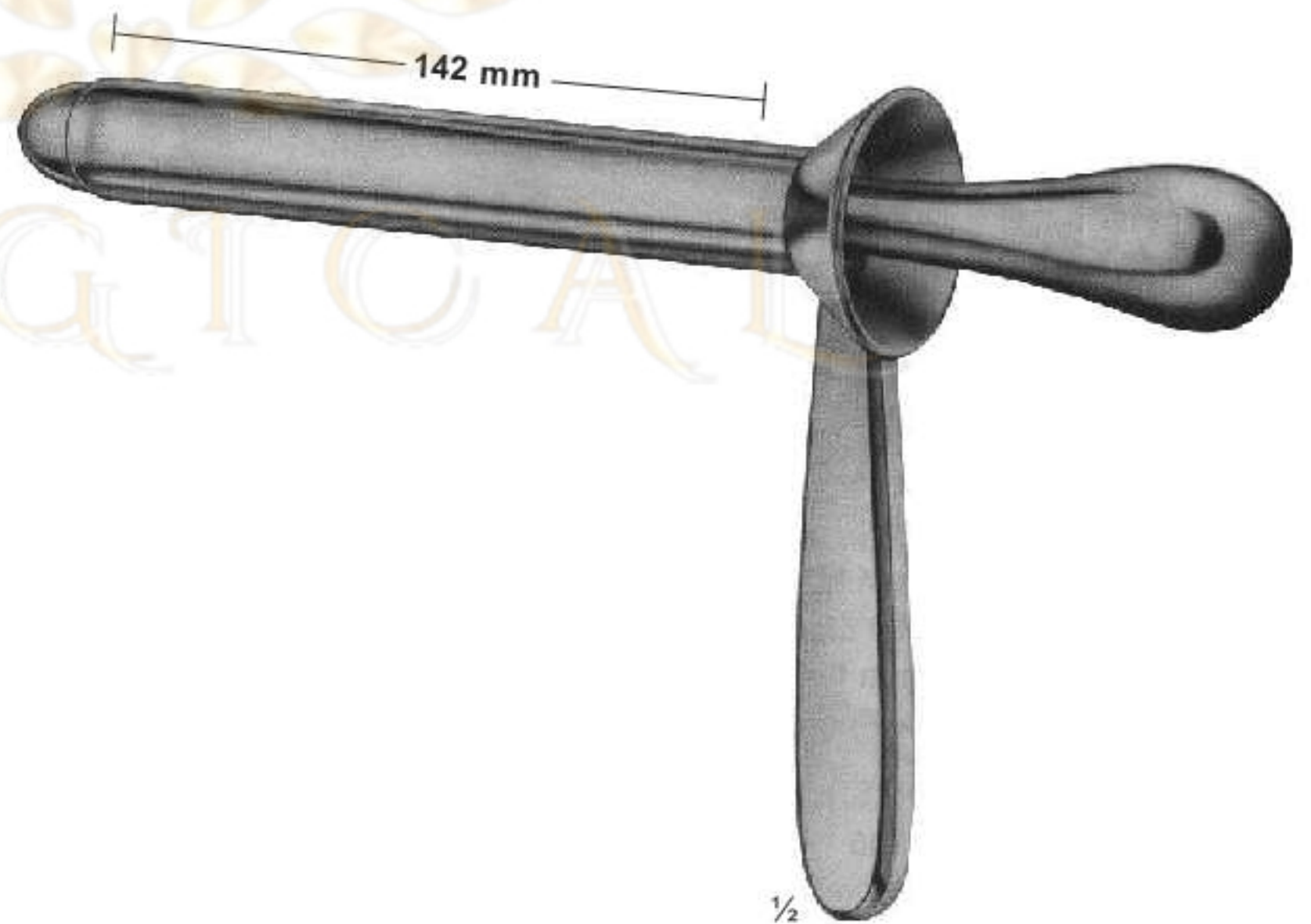

**10-113**  
KELLY  
Proctoscope  
160 mm

# Biopsy forceps for rectum

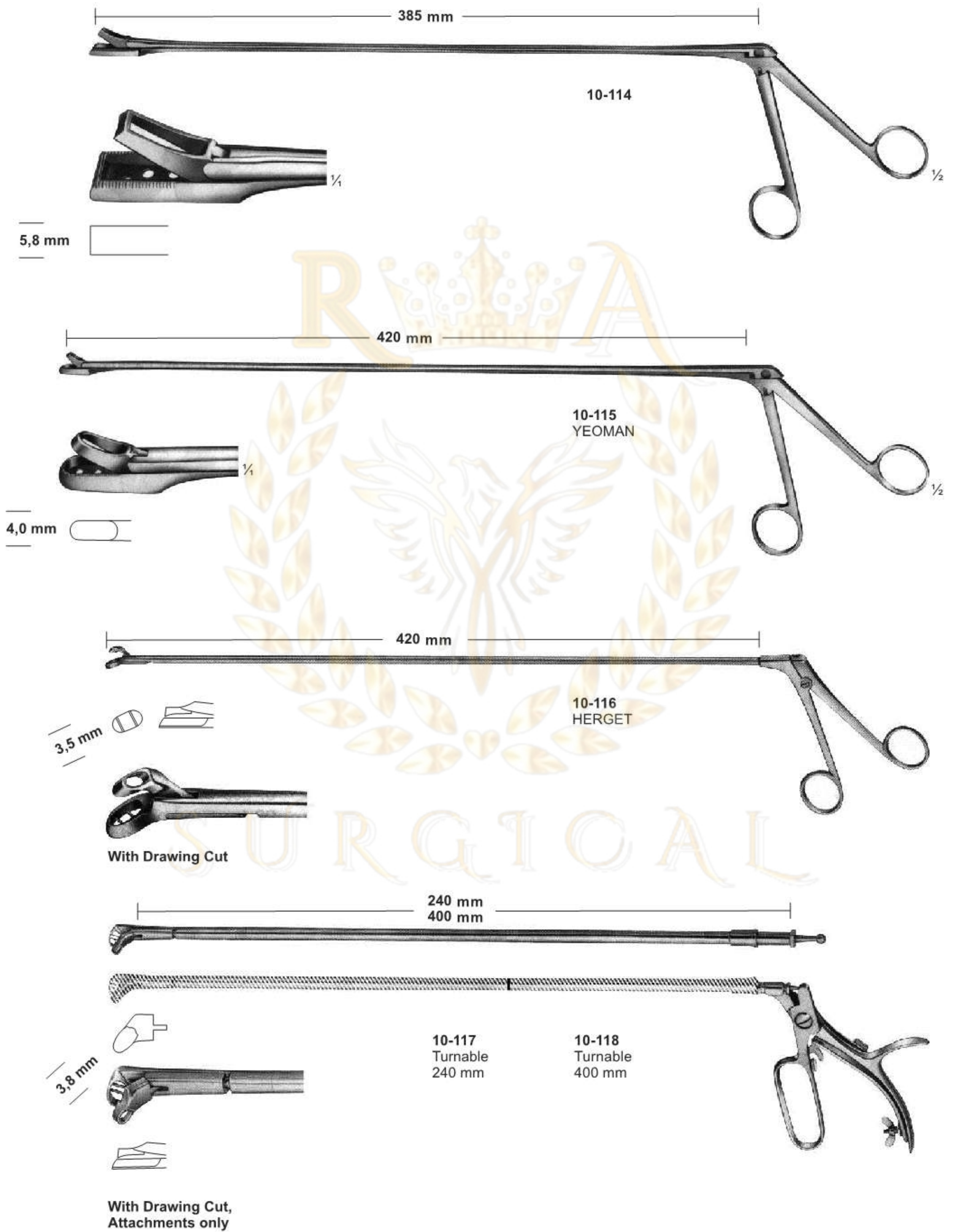

# Biopsy Forceps & Swab Holders

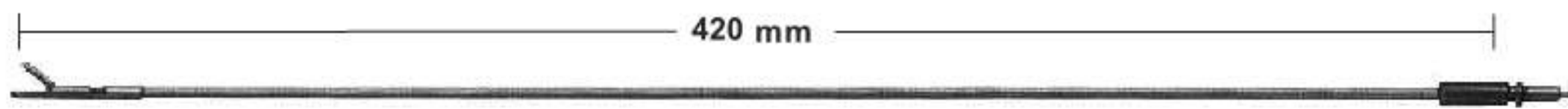

3,5 mm



10-119

3,5 mm



10-120

4,0 mm



10-121

4,0 mm



10-122



10-119 - 122  
Handle for 119 - 120 - 121 - 122



10-123  
3,5 mm



10-123 - 124  
Biopsy Forceps, spoon-shaped  
oval jaws, straight.

10-124  
4, mm



SURGICAL

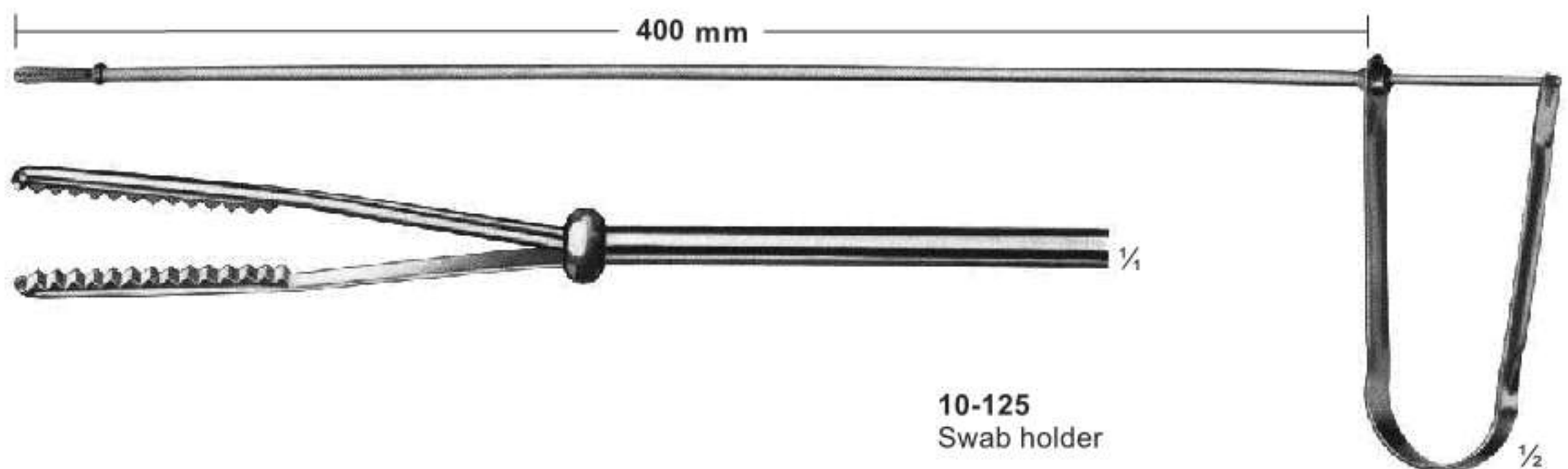

10-125  
Swab holder

# Haemorrhoidal Forceps



10-126 - 127  
LUER

10-126  
220 mm

10-127  
245 mm

10-128  
HEYWOOD-SMITH  
200 mm

10-129  
HEYWOOD-SMITH  
modif  
200 mm

# Haemorrhoidal Forceps



10-130 - 131  
250 mm  
10-131  
270 mm

10-132 - 133  
FERGUSSON  
200 mm

10-134  
RUDD  
Haemorrhoidal ligator  
with loading  
attachment and 100  
ligature rubber rings  
315 mm



# Gall Duct Forceps



**10-135**  
LOWER  
180 mm



**10-136**  
LAHEY ( SWEET )  
190 mm

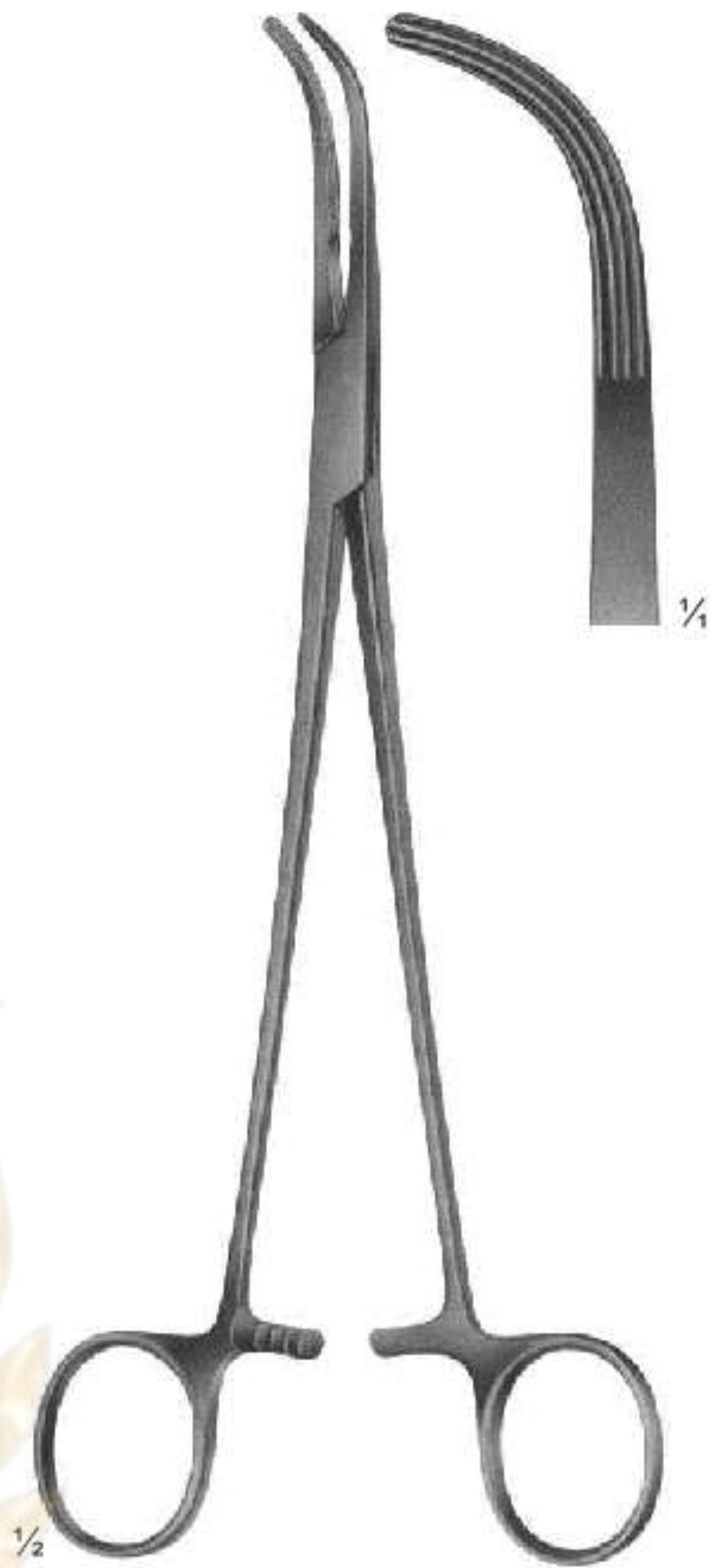

**10-137**  
LAHEY  
220 mm



**10-138**  
DESJARDINS  
Gall duct-and cystic forceps  
210 mm



**10-139**  
NISSEN  
Gall duct-and cystic forceps  
215 mm

# Gall Duct Forceps and Choledochus Forceps

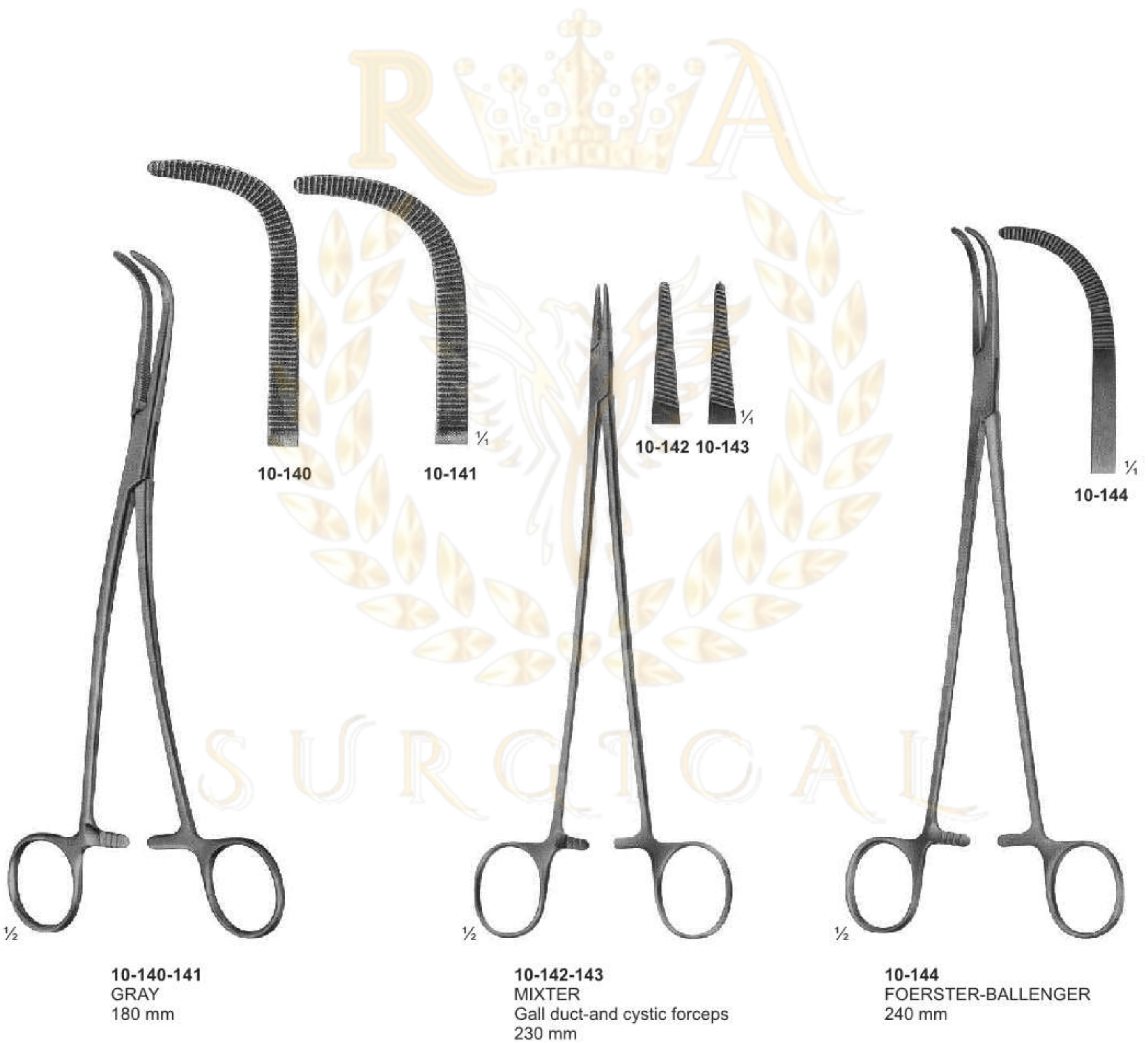

**10-140-141**  
GRAY  
180 mm

**10-142-143**  
MIXTER  
Gall duct-and cystic forceps  
230 mm

**10-144**  
FOERSTER-BALLENGER  
240 mm

# Gall Bladder Forceps and Gall Duct Scissors

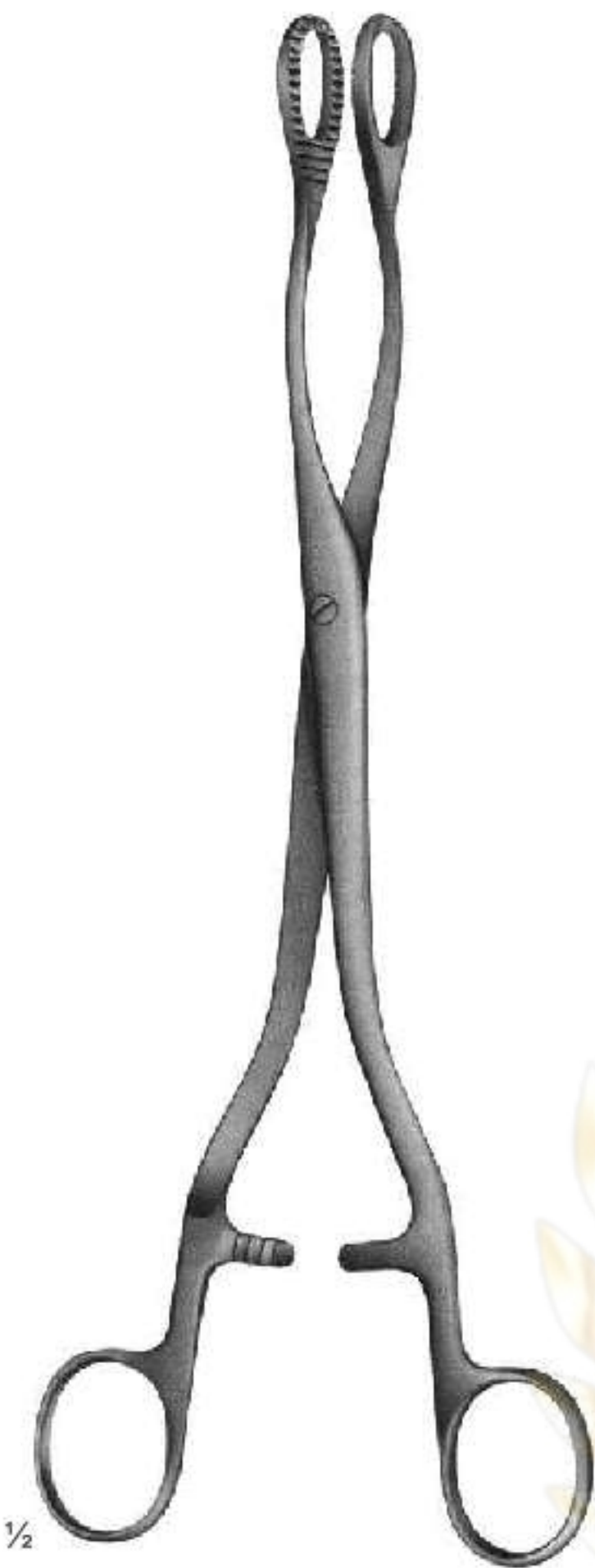

**10-145**  
HEYWOOD-SMITH  
250 mm



**10-146**  
250 mm  
**10-147**  
270 mm



**10-146**  
250 mm



**10-147**  
270 mm

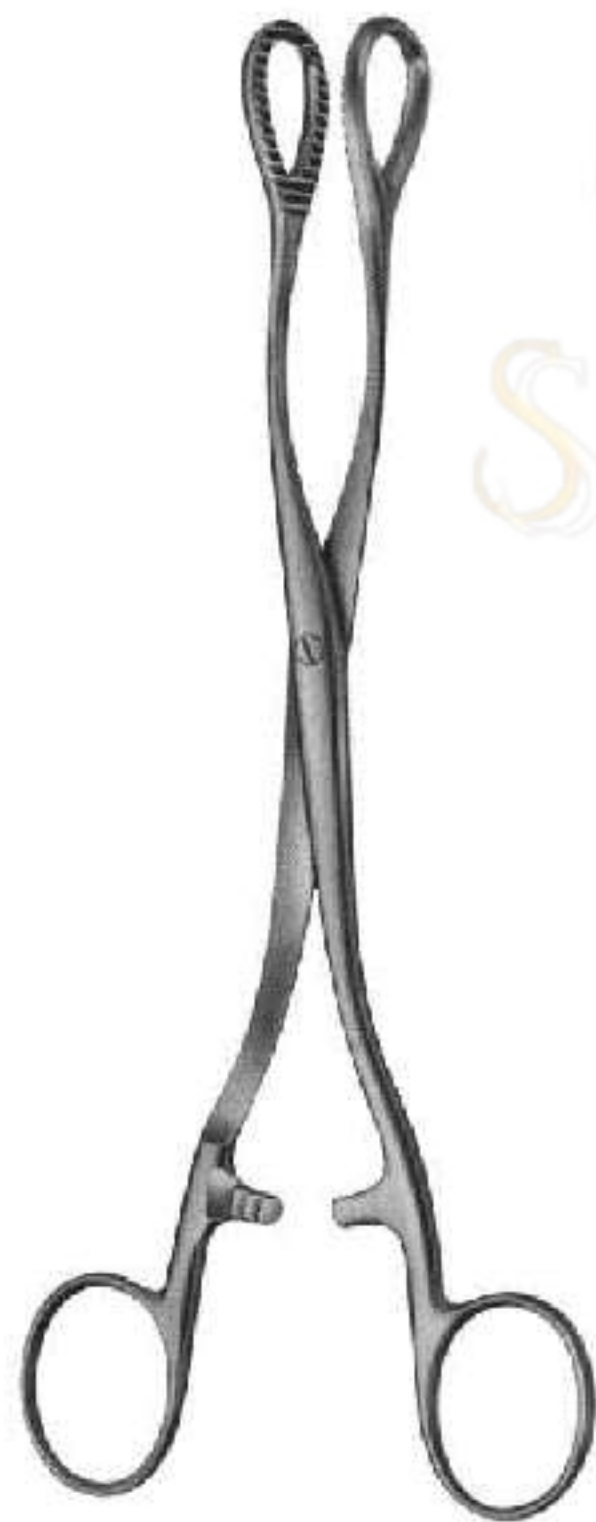

**10-148**  
HEYWOOD-SMITH  
200 mm

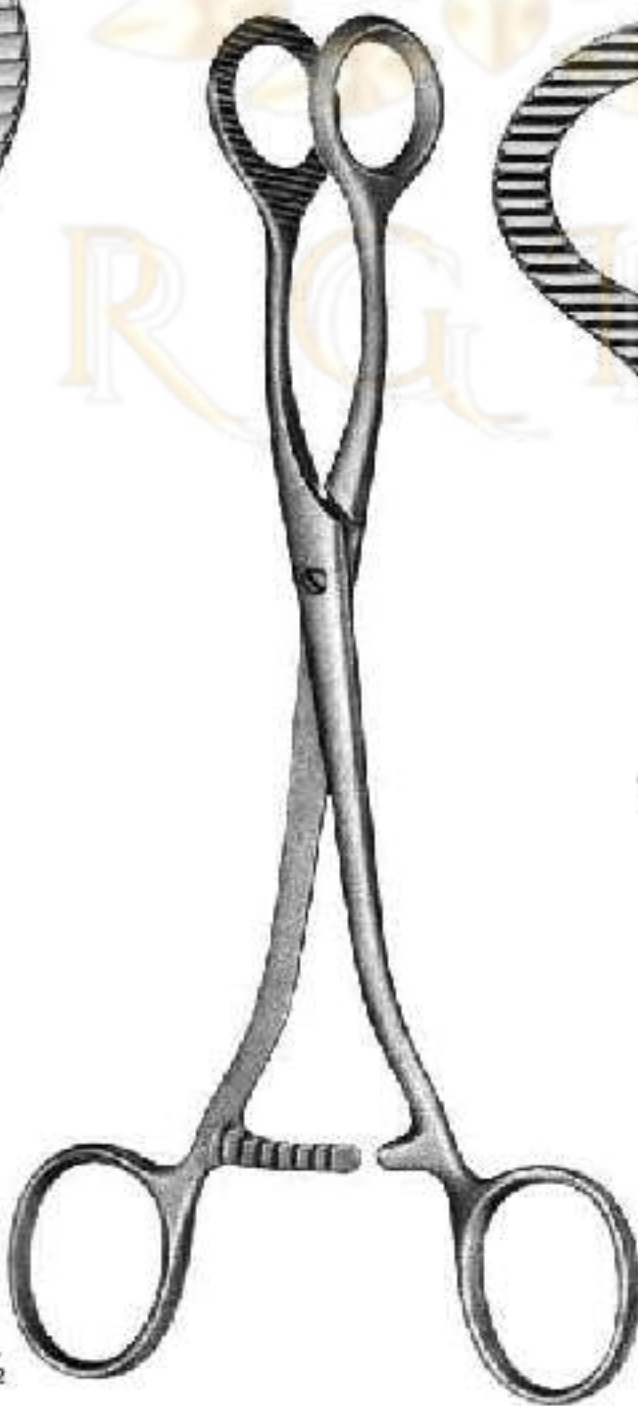

**10-149**  
DOYEN  
185 mm



**10-150 - 151**  
Gall duct scissors  
200 mm



**10-150**  
POTTS-DE  
MARTEL



**10-151**  
MILLS

# Gall Duct Probes

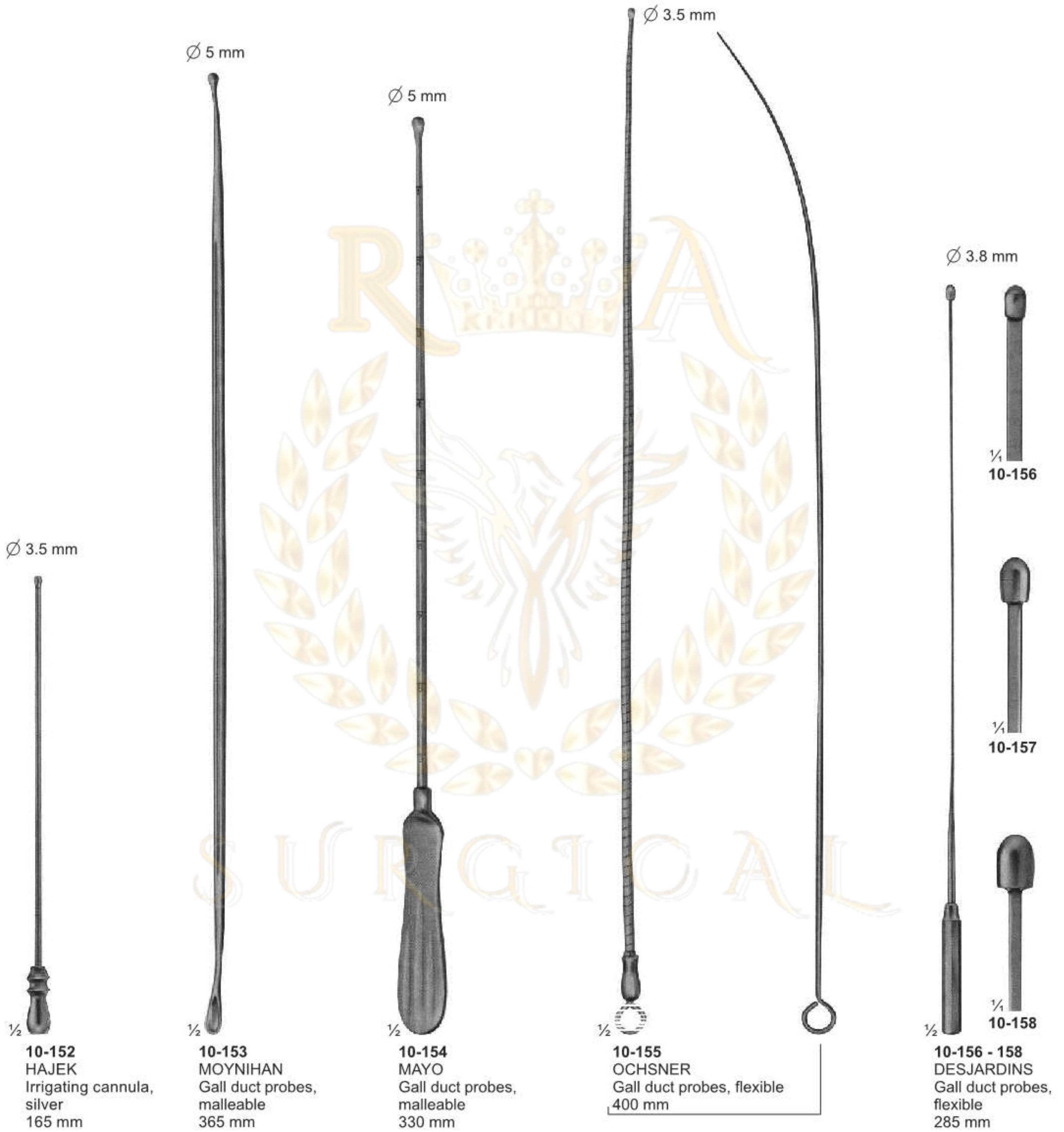

# Gall Duct Dilators & Gall Stone Scoops

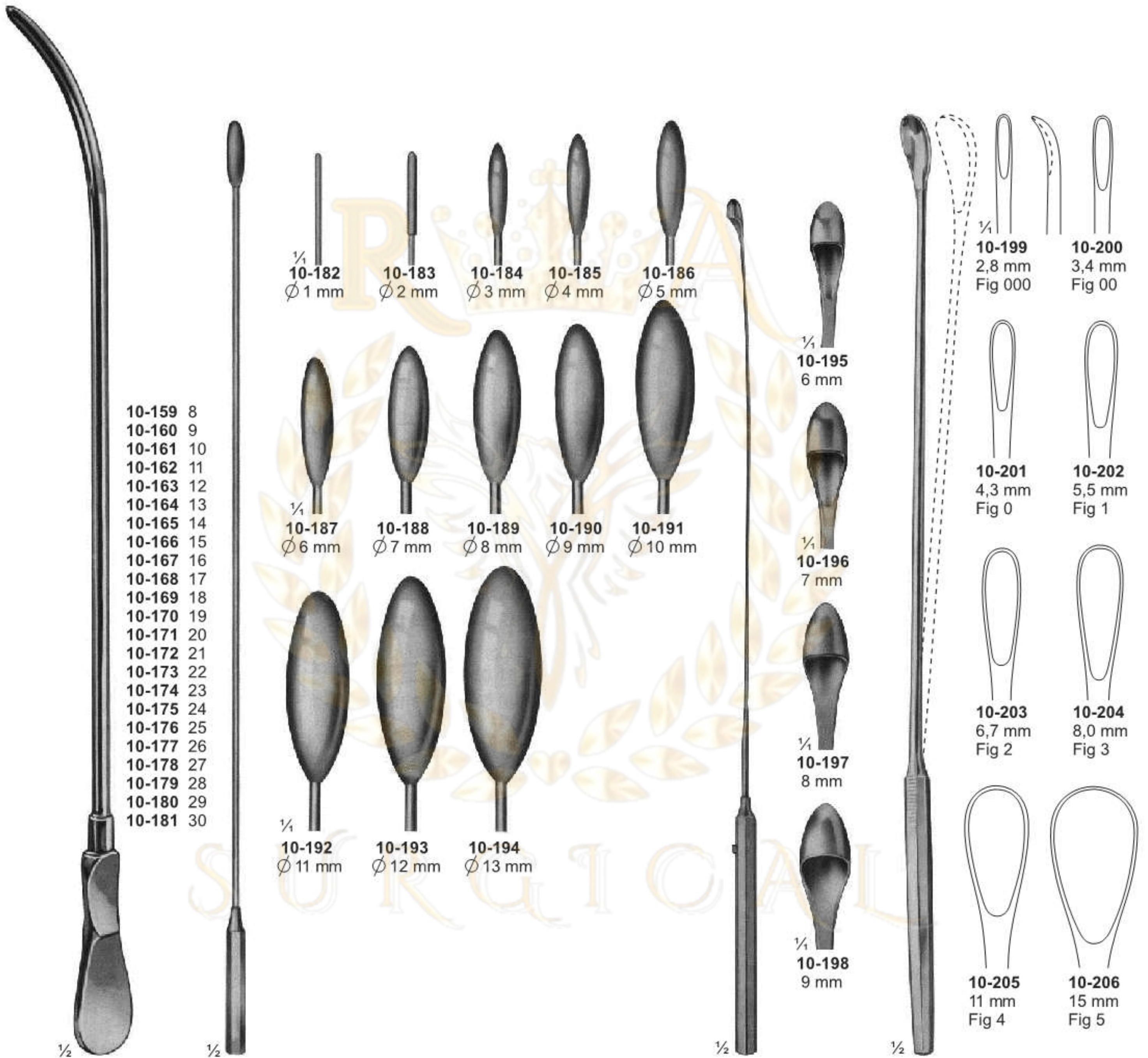

- 10-159 8
- 10-160 9
- 10-161 10
- 10-162 11
- 10-163 12
- 10-164 13
- 10-165 14
- 10-166 15
- 10-167 16
- 10-168 17
- 10-169 18
- 10-170 19
- 10-171 20
- 10-172 21
- 10-173 22
- 10-174 23
- 10-175 24
- 10-176 25
- 10-177 26
- 10-178 27
- 10-179 28
- 10-180 29
- 10-181 30

- 1/4 10-182  
Ø 1 mm
- 10-183  
Ø 2 mm
- 10-184  
Ø 3 mm
- 10-185  
Ø 4 mm
- 10-186  
Ø 5 mm
- 10-187  
Ø 6 mm
- 10-188  
Ø 7 mm
- 10-189  
Ø 8 mm
- 10-190  
Ø 9 mm
- 10-191  
Ø 10 mm
- 10-192  
Ø 11 mm
- 10-193  
Ø 12 mm
- 10-194  
Ø 13 mm

- 1/4 10-195  
6 mm
- 10-196  
7 mm
- 10-197  
8 mm
- 10-198  
9 mm

- 1/4 10-199  
2,8 mm  
Fig 000
- 10-200  
3,4 mm  
Fig 00
- 10-201  
4,3 mm  
Fig 0
- 10-202  
5,5 mm  
Fig 1
- 10-203  
6,7 mm  
Fig 2
- 10-204  
8,0 mm  
Fig 3
- 10-205  
11 mm  
Fig 4
- 10-206  
15 mm  
Fig 5

**10-159 - 181**  
DITTEL  
Metall bougies and dilating sounds, stiff 345 mm

**10-182 - 194**  
BAKES  
Common bile duct dilators, malleable 315 mm, 320 mm

**10-195 - 198**  
DESJARDINS  
Probes and catch with flexible shaft 300 mm

**10-199 - 206**  
LUER-KORTE modif with malleable shaft 310 mm

# Gall Stone Forceps

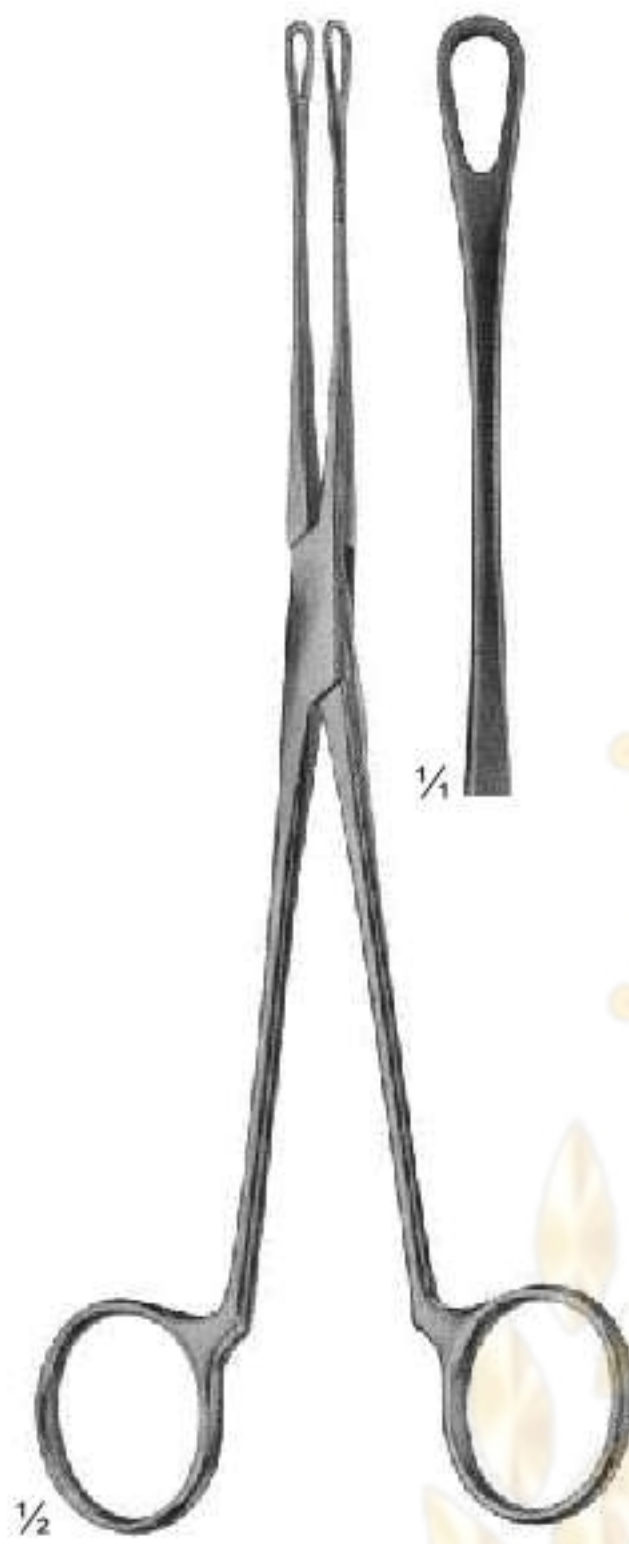

**10-207**  
BLAKE  
205 mm

**10-208**  
BLAKE  
205 mm

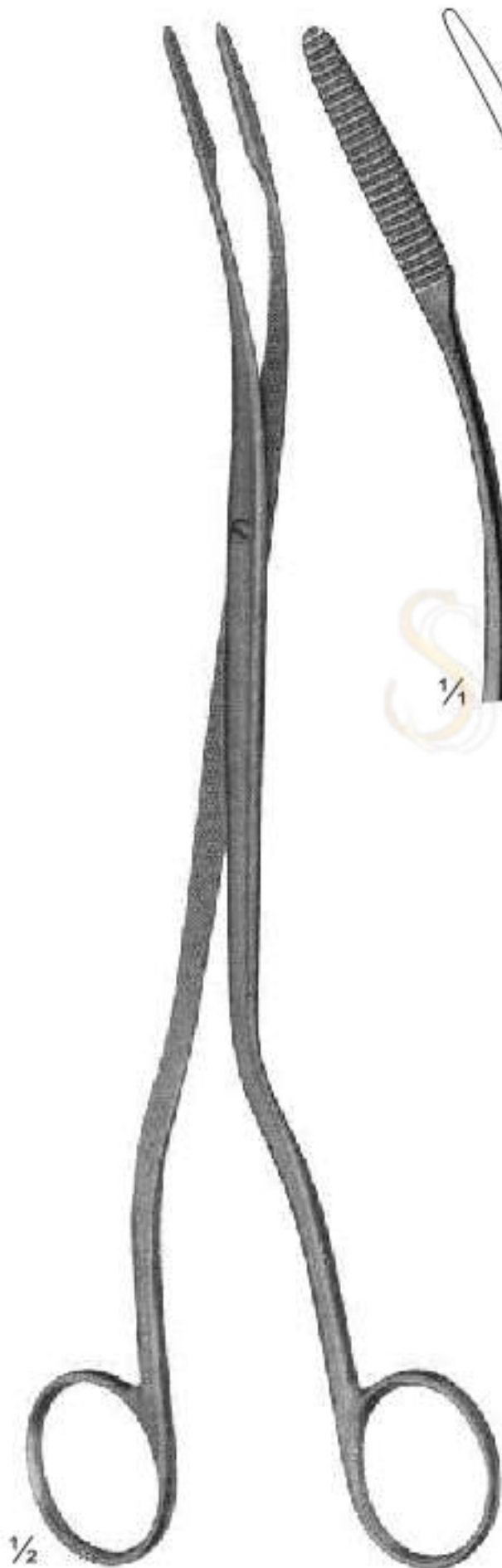

**10-209**  
CZERNY  
245 mm



**10-210 - 213**  
DESJARDINS  
225 mm



**10-210**

**10-211**

**10-212**

**10-213**



**10-214**  
240 mm



**10-215**  
225 mm

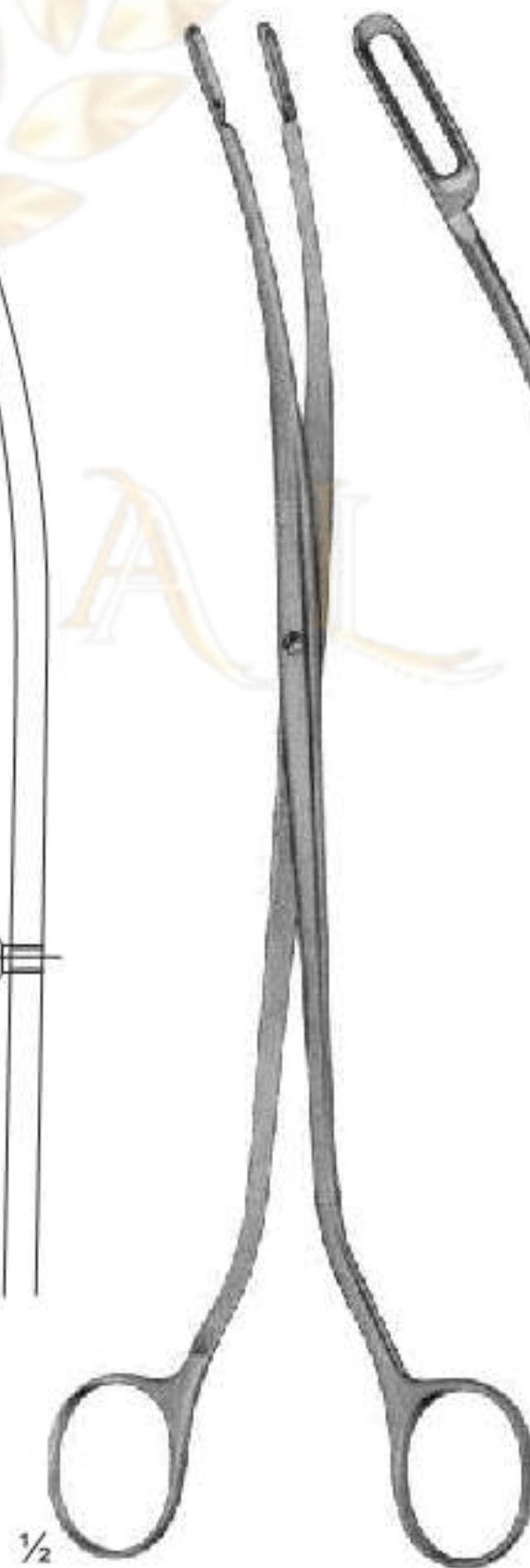

**10-214 - 215**  
DESJARDINS  
Extremely delicate patterns

# Kidney Clamps

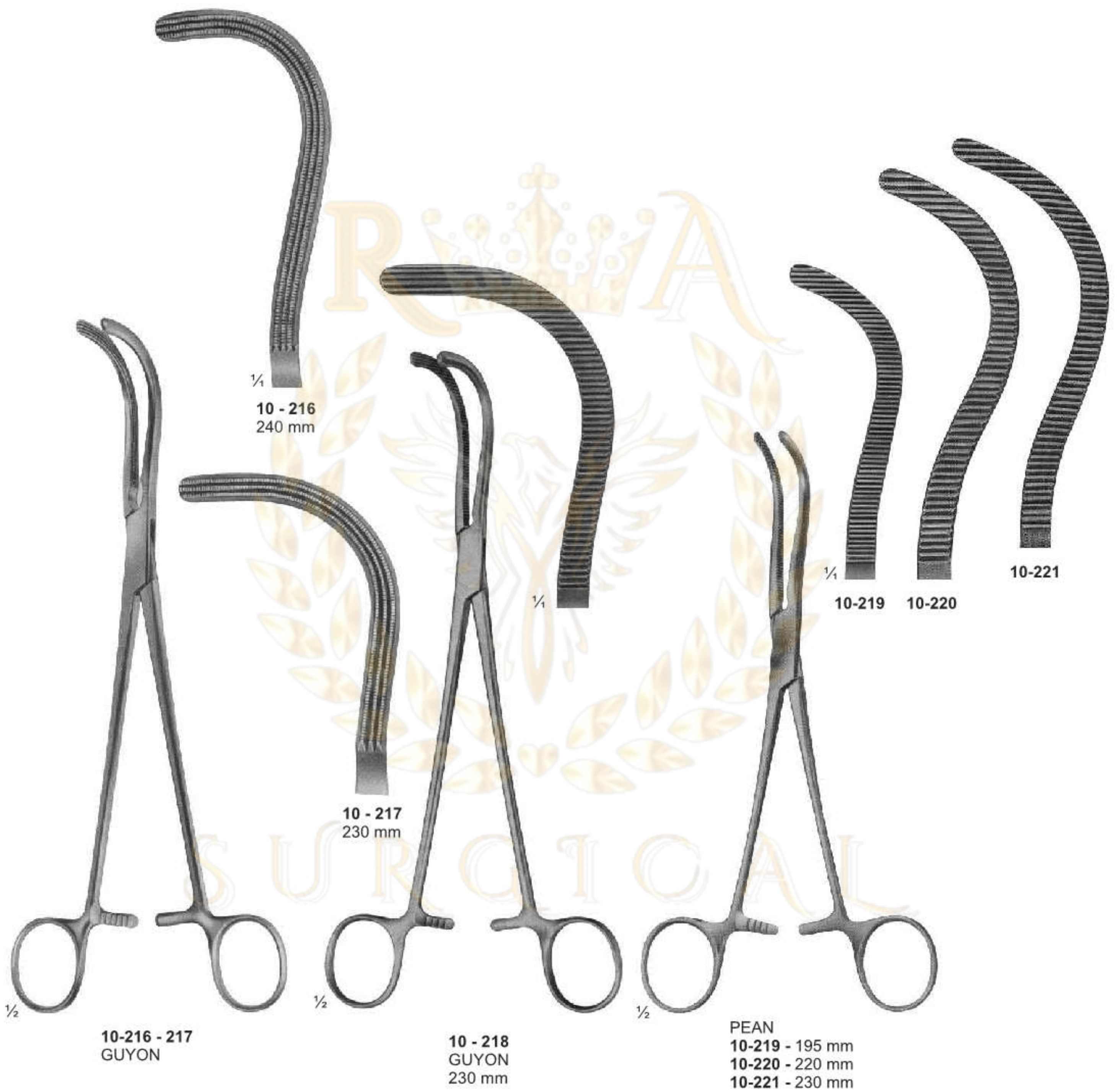

# Kidney Clamps





# Kidney Elevating Forceps



**10-225**  
COLLIN  
285 mm



**10-226**  
DARTIGUES  
255 mm

# Kidney Stone Forceps

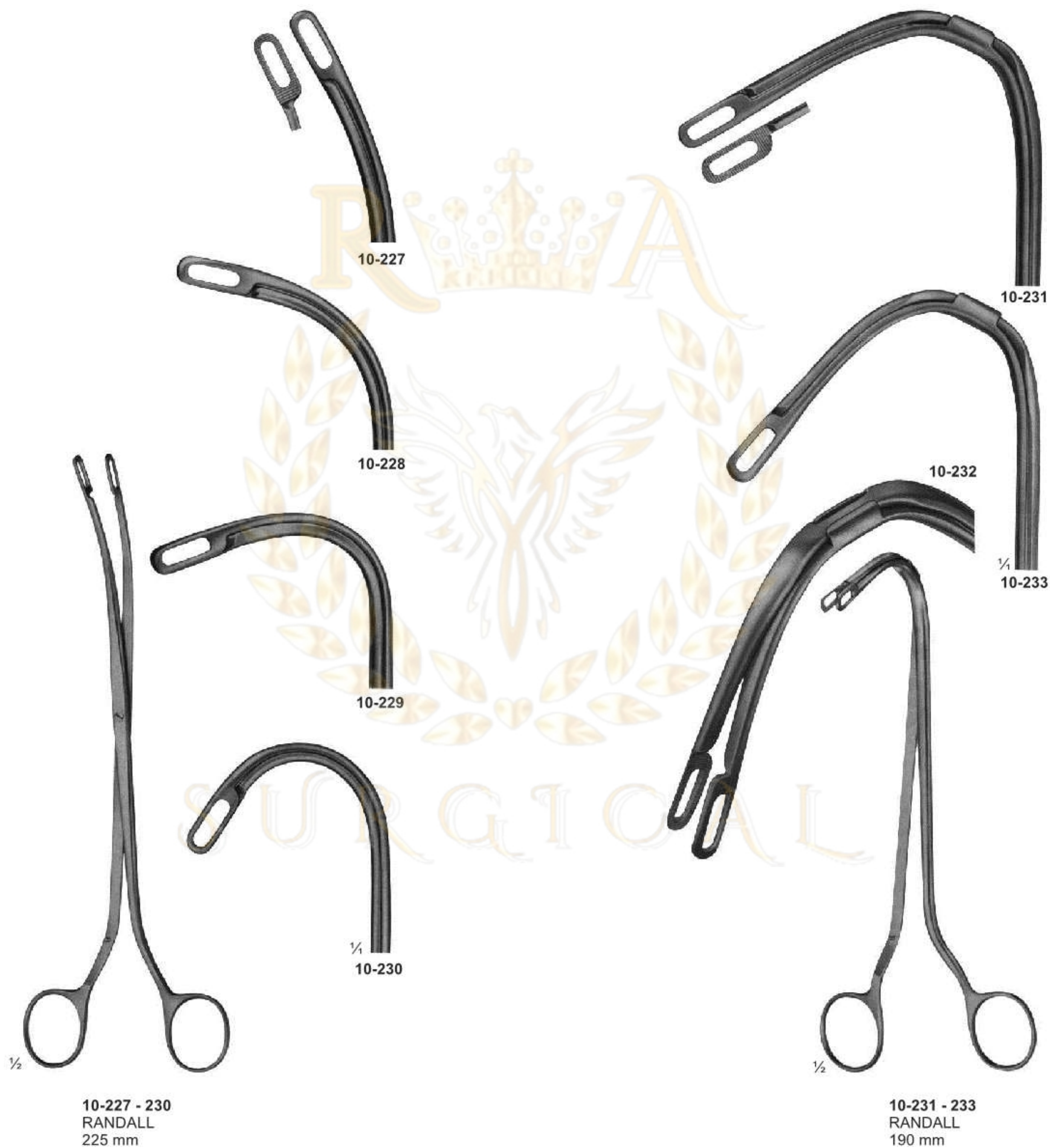

10-227 - 230  
RANDALL  
225 mm

10-231 - 233  
RANDALL  
190 mm

# Bladder Retractors



**11-101**  
JUDD-MASSON  
Bladder-and suprapubic  
retractor



**11-102**  
MILLIN  
Bladder retractor  
105X45 mm



**11-103**  
LEGUEU  
Bladder retractor  
Center blade  
80 x 31 mm

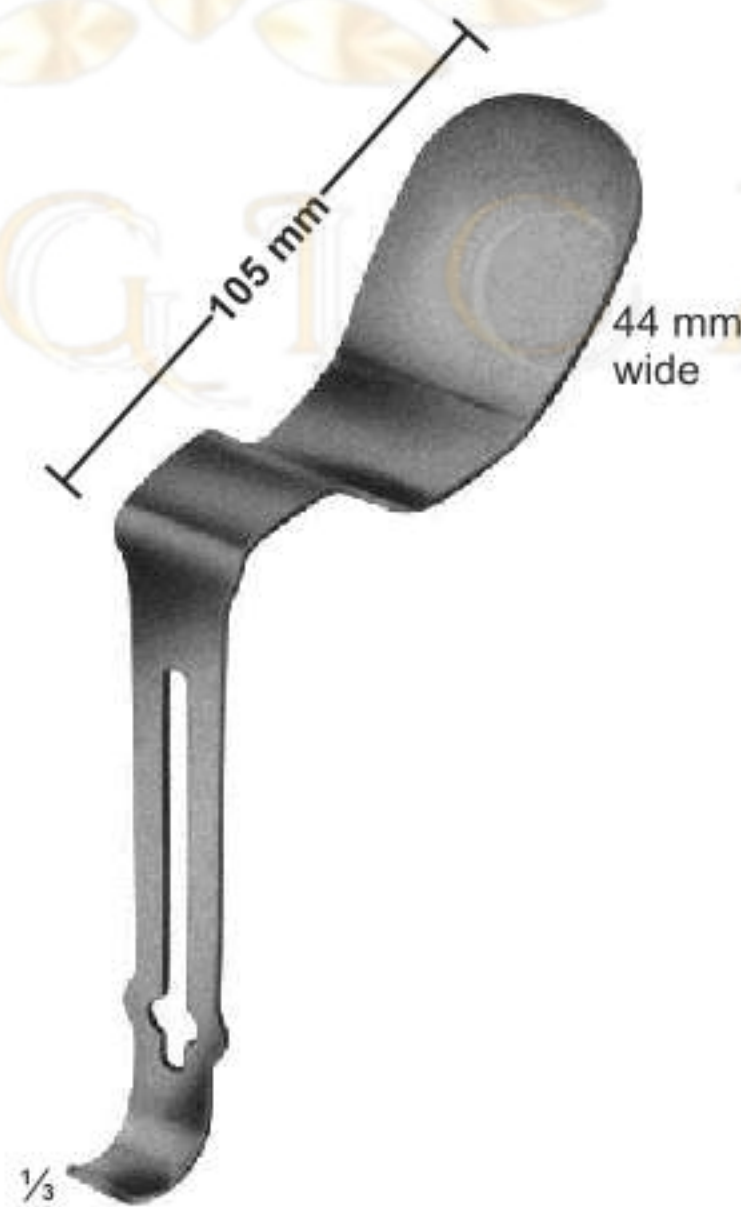

**11-104**  
MILLIN  
Center bladder for  
retro pubic prostatectomy

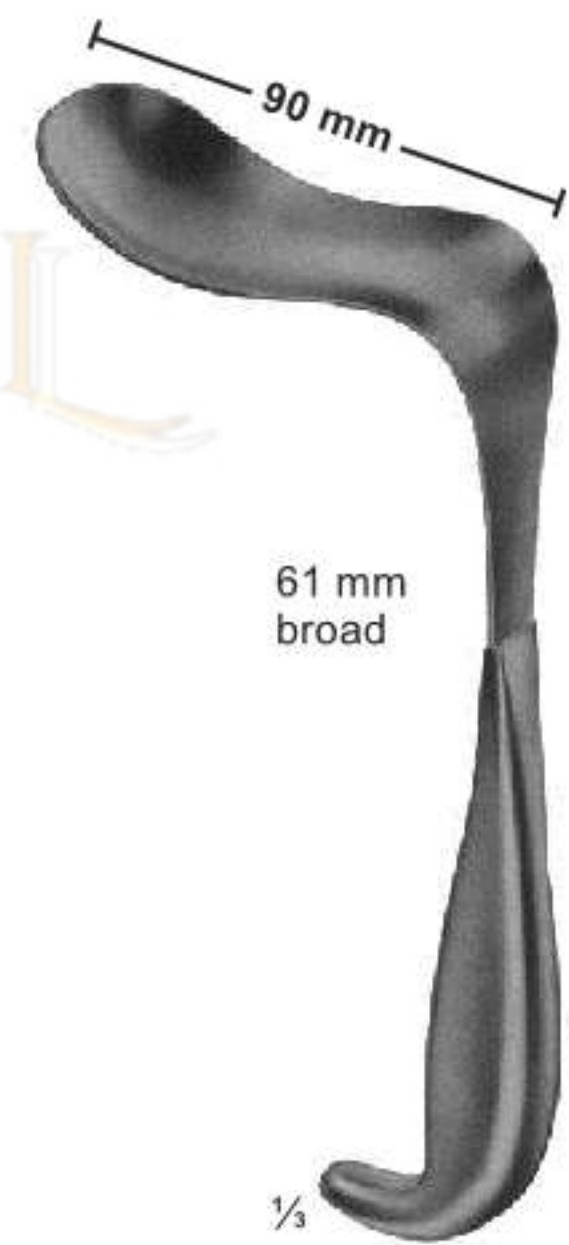

**11-105**  
KOCHER  
Bladder spatula  
235 mm



**11-106**  
MATHIEU  
Foreign body forceps  
Length of shaft  
190 mm



**11-107**  
MILLIN  
Lobe grasping  
forceps  
245 mm

**11-108**  
MILLIN  
Lobe grasping  
forceps  
235 mm

**11-109**  
MILLIN  
Bladder neck spreader  
285 mm

**11-110**  
Ureter forceps  
240 mm

# Genito-Urinary Instruments



**11-111**  
GUYON  
Catheter guide  
(introducer)  
365 mm



**11-112 - 124**  
Female catheters,  
metal  
160 mm

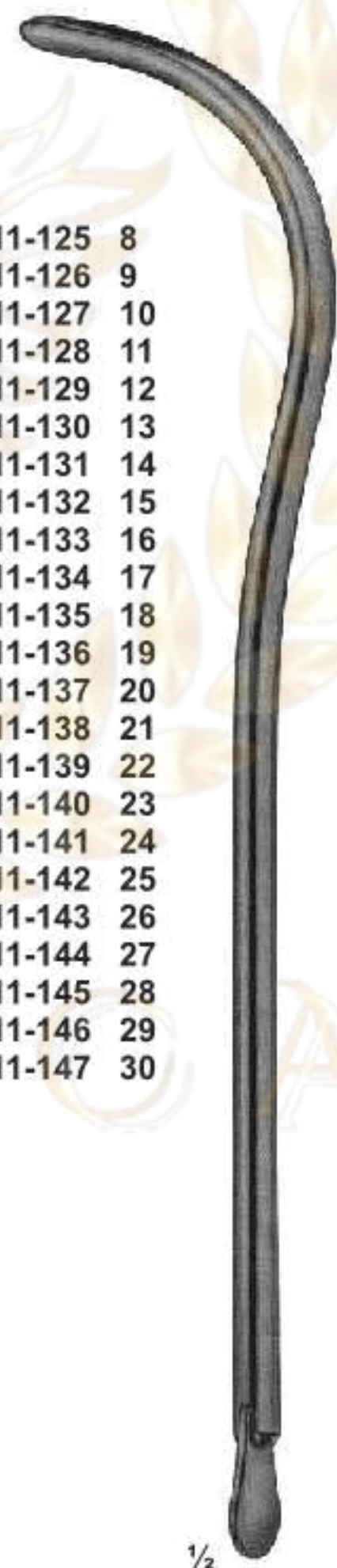

**11-125 - 147**  
Urethral bougies  
and dilating sounds  
345 mm

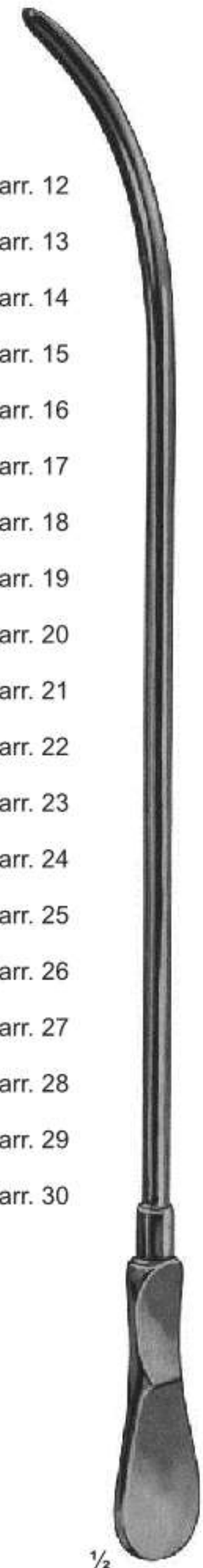

**11-148 - 184**  
Urethral bougies  
and dilating sounds  
255 mm

- 11-112 6
- 11-113 7
- 11-114 8
- 11-115 9
- 11-116 10
- 11-117 11
- 11-118 12
- 11-119 13
- 11-120 14
- 11-121 15
- 11-122 16
- 11-123 18
- 11-124 20

- 11-125 8
- 11-126 9
- 11-127 10
- 11-128 11
- 11-129 12
- 11-130 13
- 11-131 14
- 11-132 15
- 11-133 16
- 11-134 17
- 11-135 18
- 11-136 19
- 11-137 20
- 11-138 21
- 11-139 22
- 11-140 23
- 11-141 24
- 11-142 25
- 11-143 26
- 11-144 27
- 11-145 28
- 11-146 29
- 11-147 30

- 11-148 Ben. 24/Charr. 12
- 11-149 Ben. 25
- 11-150 Ben. 26/Charr. 13
- 11-151 Ben. 27
- 11-152 Ben. 28/Charr. 14
- 11-153 Ben. 29
- 11-154 Ben. 30/Charr. 15
- 11-155 Ben. 31
- 11-156 Ben. 32/Charr. 16
- 11-157 Ben. 33
- 11-158 Ben. 34/Charr. 17
- 11-159 Ben. 35
- 11-160 Ben. 36/Charr. 18
- 11-161 Ben. 37
- 11-162 Ben. 38/Charr. 19
- 11-163 Ben. 39
- 11-164 Ben. 40/Charr. 20
- 11-165 Ben. 41
- 11-166 Ben. 42/Charr. 21
- 11-167 Ben. 43
- 11-168 Ben. 44/Charr. 22
- 11-169 Ben. 45
- 11-170 Ben. 46/Charr. 23
- 11-171 Ben. 47
- 11-172 Ben. 48/Charr. 24
- 11-173 Ben. 49
- 11-174 Ben. 50/Charr. 25
- 11-175 Ben. 51
- 11-176 Ben. 52/Charr. 26
- 11-177 Ben. 53
- 11-178 Ben. 54/Charr. 27
- 11-179 Ben. 55
- 11-180 Ben. 56/Charr. 28
- 11-181 Ben. 57
- 11-182 Ben. 58/Charr. 29
- 11-183 Ben. 59
- 11-184 Ben. 60/Charr. 30



**11-185**  
**GUYON**  
Set of urethral bougies and dilating sounds,  
in metal case, with lift out rack and bottom  
rack, containing 21 urethral and dilating sounds.



**11-186**  
**WINKELMANN**  
**Circumcision Clamps**  
12 mm / 16 mm / 20 mm

# Trocars

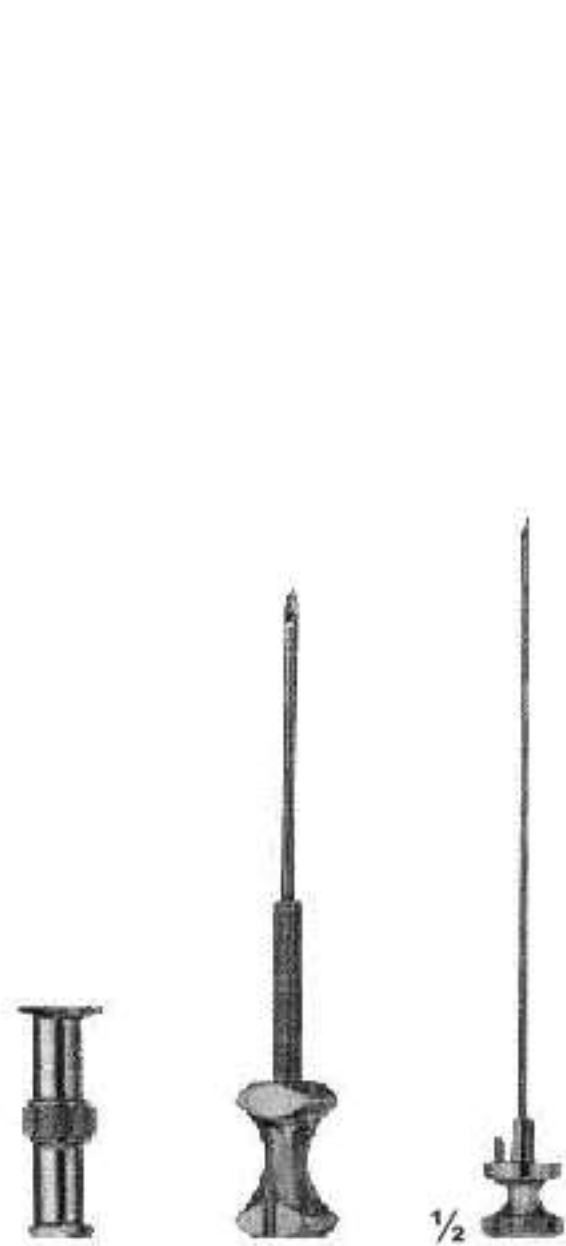

**11-187**  
KLIMA ROSEGGER  
35 X 1,8 mm  
Sternal puncture needle

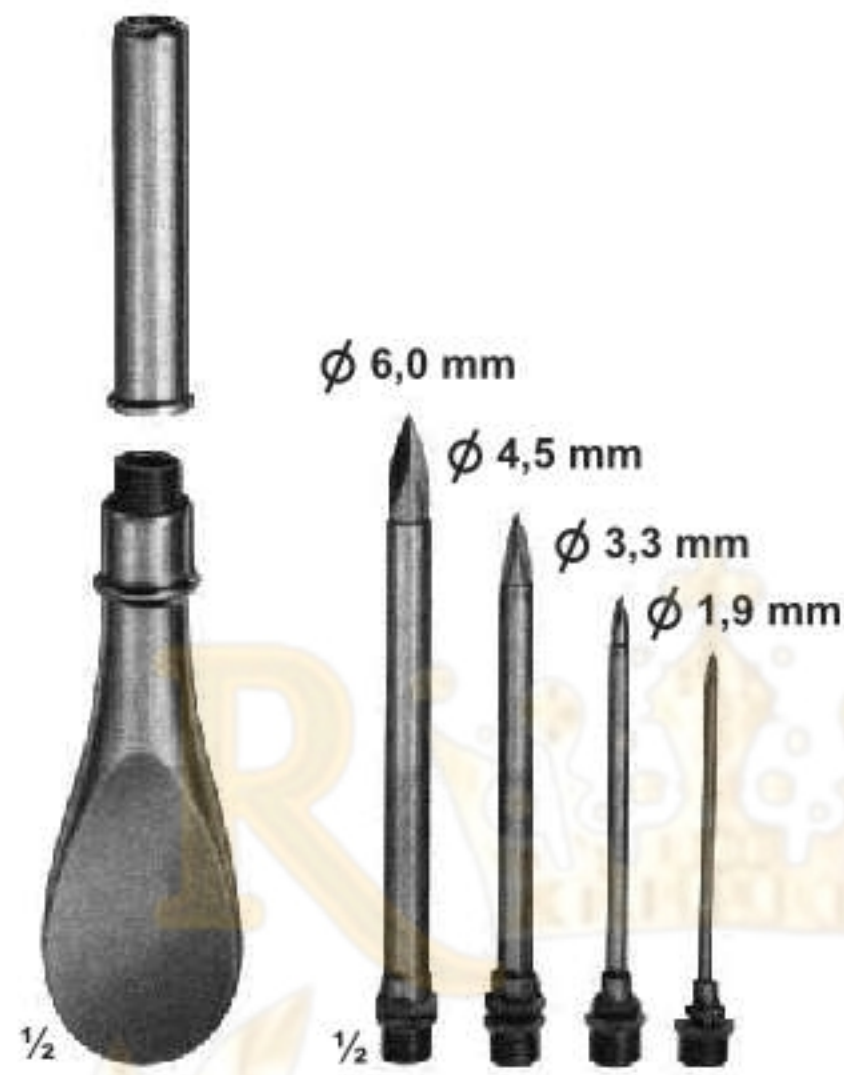

**11-188**  
Universal trocar  
with 4 tips



**11-189 - 193**  
Inside dime. Outside dime  
**11-189** 2,2 mm 3,0 mm  
**11-190** 3,0 mm 4,0 mm  
**11-191** 4,0 mm 5,0 mm  
**11-192** 5,0 mm 6,0 mm  
**11-193** 5,5 mm 6,5 mm  
 for hydrocele and abdominal puncture



**11-194 - 197**  
Inside dime. Outside dime  
**11-194** 2,2 mm 3,0 mm  
**11-195** 3,0 mm 4,0 mm  
**11-196** 4,0 mm 5,0 mm  
**11-197** 5,0 mm 6,0 mm  
 for abdominal puncture,  
 with stop-cock and lateral drain

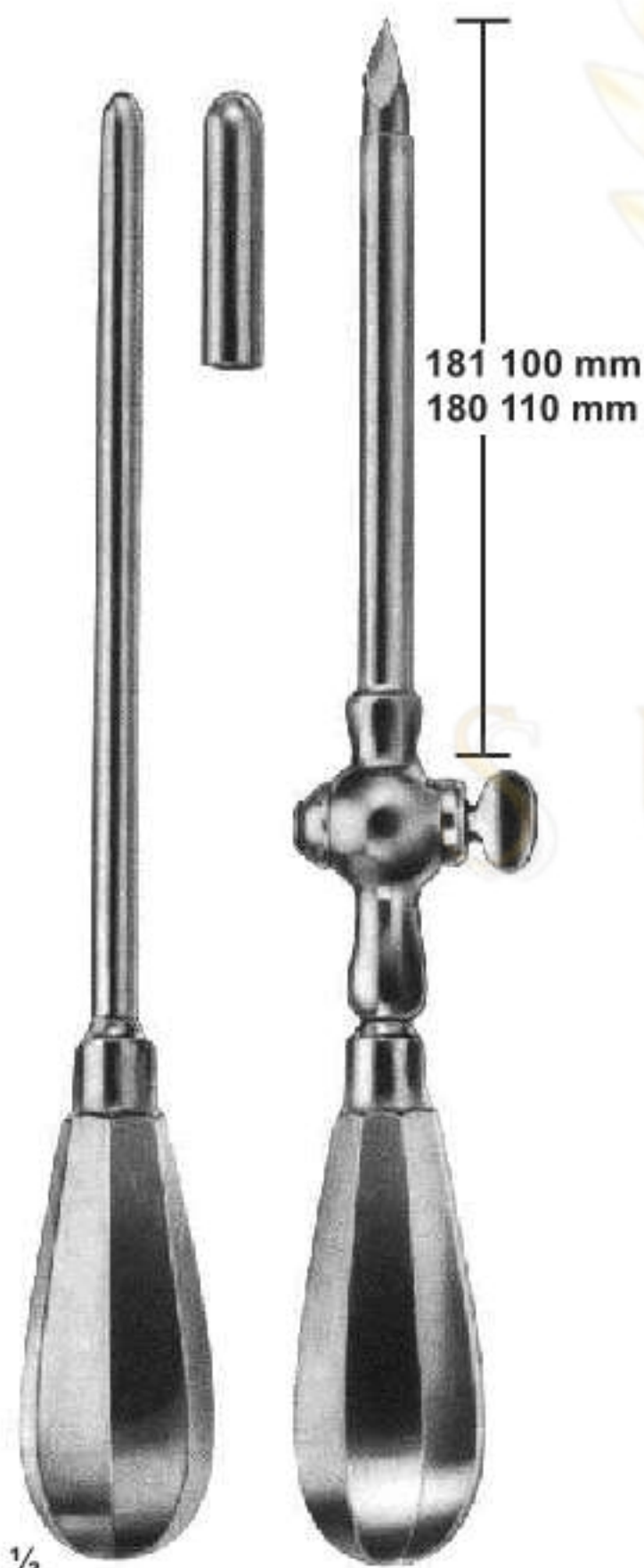

**11-198 - 199**  
Inside dime. Outside dime  
**11-198** 6,5 mm 8,0 mm  
**11-199** 9,0 mm 10,0 mm  
 Empyema trocar

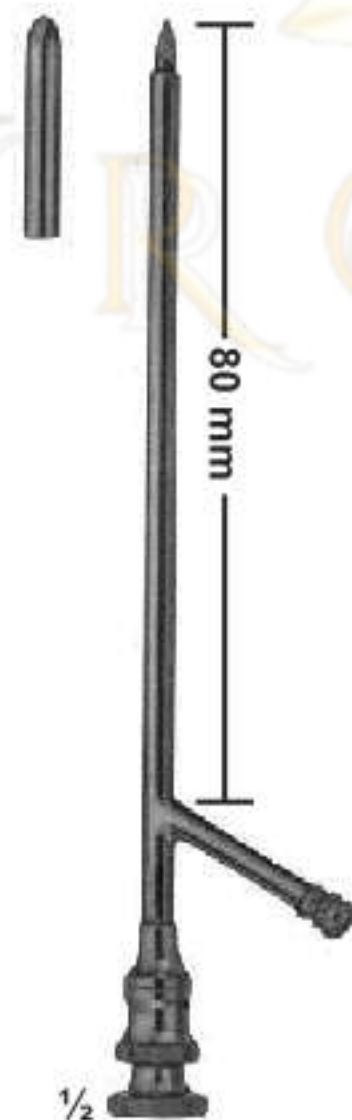

**11-200 - 203**  
Inside dime. Outside dime  
**11-200** 3,0 mm 4,0 mm  
**11-201** 3,6 mm 4,6 mm  
**11-202** 4,3 mm 5,3 mm  
**11-203** 5,0 mm 6,0 mm  
 Gall bladder trocars



**11-204**  
PIERCE  
Antrum trocar  
4,0 mm



**11-205**  
COAKLEY  
Antrum trocar  
3,0 mm

# Vaginal specula

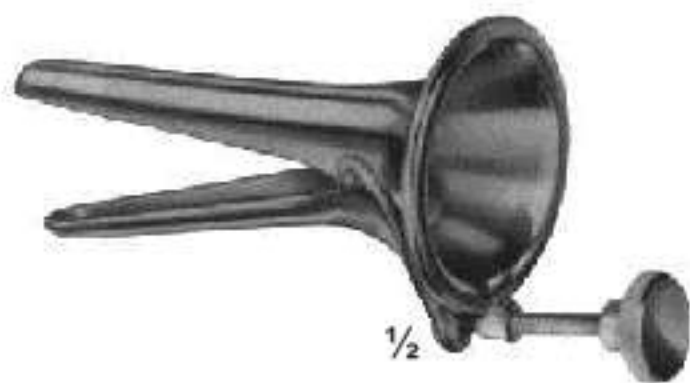

**12-101**  
COLLIN  
for children  
53 x 10 mm

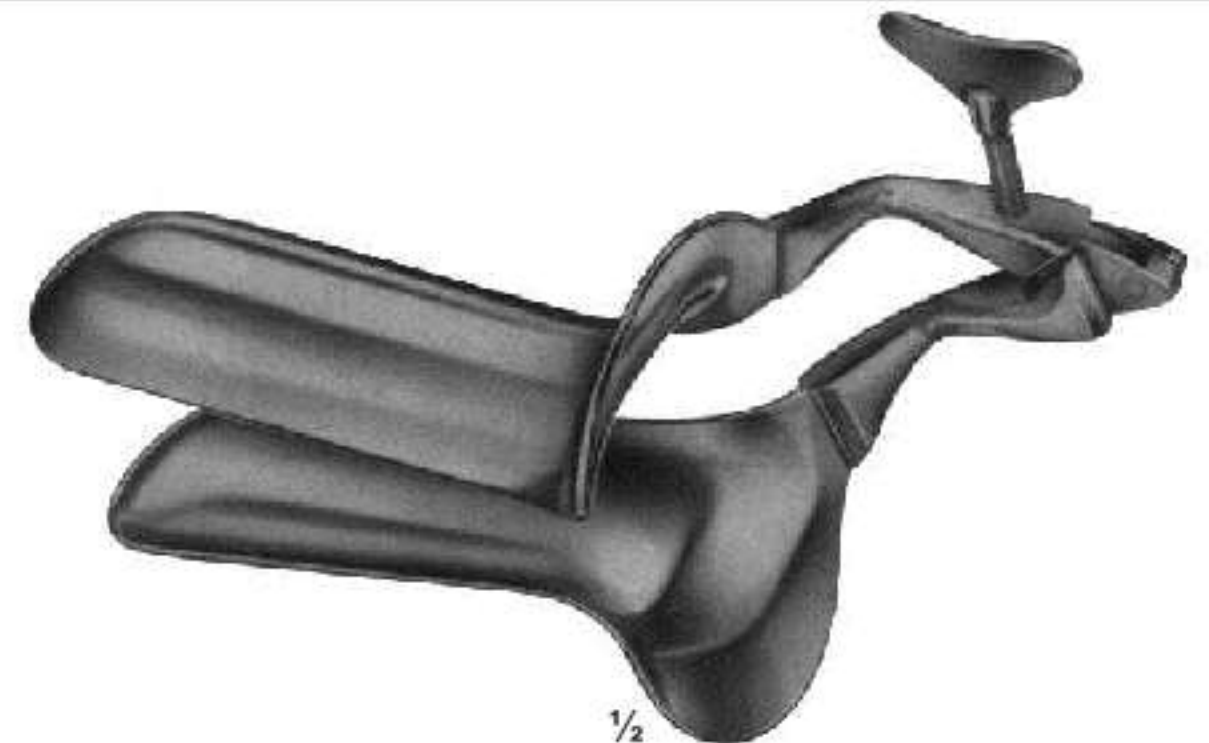

**12-102 - 105**  
COLLIN

<b>12-102</b>	100/90mm	28 mm
<b>12-103</b>	100/90mm	32 mm
<b>12-104</b>	105/95mm	35 mm
<b>12-105</b>	115/105mm	40 mm
Total length/working length		width



**12-106**  
COLLIN  
for virgins  
95/85 x 18 mm



**12-107**  
CUSCO  
for virgins  
75 x 17 mm



**12-108**  
CUSCO  
for virgins  
75 x 17 mm



**12-109 - 111**  
CUSCO

<b>12-109</b>	92X23-25 mm
<b>12-110</b>	100x25-27 mm
<b>12-111</b>	110x27-30 mm



# Vaginal Specula



1/2

**12-112 - 115**  
CUSCO  
STANDARD  
12-112 80X24 mm  
12-113 80X32 mm  
12-114 90X36 mm  
12-115 110X37 mm



1/2

**12-116 - 119**  
CUSCO  
12-116 80X24 mm  
12-117 80X32 mm  
12-118 90X36 mm  
12-119 110X37 mm



1/2

**12-120 - 122**  
CUSCO  
12-120 80X24 mm  
12-121 80X32 mm  
12-122 115X36 mm



1/2

**12-123 - 124**  
SEYFFERT  
12-123 100X24 mm  
12-124 110X32 mm  
230 mm



1/2

**12-125**  
SEMM  
for children  
and virgins  
180 mm

# Vaginal Specula, Sets, Upper & Lower Blades



**12-126 - 128**  
GRAVE  
12-126 75X20 mm  
12-127 95X30 mm  
12-128 105X33 mm

1/2

**12-129 - 130**  
PEDERSON  
12-129 100X22 mm  
12-130 120X25 mm

1/2

**12-131 - 132**  
BRIESKY  
12-131 72X25 mm / 77X30 mm  
12-132 75X30 mm / 92X38 mm  
170 mm

1/2



1/2

**12-133 - 134**  
BREISKY  
12-133 100X22 mm  
77 X30 mm  
140 mm  
12-134 120X25 mm  
92 X38 mm  
170 mm



1/2

**12-135 - 137**  
SEIDL  
12-135 80X8 mm  
12-136 80X10 mm  
12-137 90X14 mm  
For children and infants  
170 mm



1/2

**12-138**  
KRISTELLER  
70X15 mm, ( 170 mm )  
For children



1/2

**12-139 - 141**  
SIMS  
12-139 70X26 mm  
75 X30 mm 125 mm  
12-140 75X30 mm  
80 X85 mm 150 mm  
11-141 80X36 mm  
90 X40 mm 175 mm

# Vaginal Specula-Sets, upper and lower blades



**12-142 - 146**  
KRISTELLER  
12-142 110X18 mm  
12-143 110X20 mm  
12-144 110X27 mm  
12-145 110X30 mm  
12-146 110X36 mm  
220 mm

**12-147 - 150**  
KRISTELLER  
Upper blades

**12-151 - 154**  
KRISTELLER  
Lower blades

# Vaginal Specula-upper and lower blades



12-155 115X14 mm  
215 mm

12-160 110X18 mm  
215 mm

12-156 115X23 mm  
215 mm

12-161 110X27 mm  
215 mm

12-157 115X16 mm  
220 mm

12-162 110X20 mm  
220 mm

12-158 115X26 mm  
220 mm

12-163 110X30 mm  
220 mm

12-159 120X30 mm  
225 mm

12-164 110X36 mm  
225 mm

12-155 - 159  
KRISTELLER  
Upper blades

12-160 - 164  
KRISTELLER  
Lower blades

# Vaginal Specula



# Vaginal Specula-for children & virgins / Vario Retractor



56 x 13 mm

1/2

**12-171**  
BRAUN  
180 mm



60 x 10 mm

1/2

**12-172**  
BRAUN  
180 mm



95 x 17 - 30 mm

1/2

**12-173**  
MATHIEU  
For children  
and virgins  
210 mm



95 x 17-26 mm

1/2

**12-174**  
MATHIEU  
for children and  
virgins fitting  
210 mm



**12-175**  
Handle with cold light  
carrier for upper blades  
280 mm

1/2

# Vaginal Specula-for children and virgins



1/2

**12-176 - 178**  
DOYEN  
235 mm

**12-176**  
60 X 45 mm

**12-177**  
90 X 45 mm

**12-178**  
112 X 45 mm

1/4

1/4

1/2

**12-179 - 189**

	Width of blades		
	35 mm	45 mm	60 mm
Length of blades	60 mm	35 mm	45 mm
	90 mm	<b>12-179</b>	<b>12-182</b>
	120 mm	<b>12-180</b>	<b>12-183</b>
	160 mm	<b>12-181</b>	<b>12-184</b>
		60 mm	<b>12-186</b>
			<b>12-187</b>
			<b>12-188</b>
			<b>12-189</b>

# Vaginal Specula / Retractors



1/2

**12-190 - 194**  
BREISKY  
WIENER MODELL/  
VIENNA PATTERN  
12-190 100 X 20 mm  
12-191 100 X 25 mm  
12-192 100 X 30 mm  
12-193 100 X 35 mm  
12-194 100 X 40 mm  
300 mm



1/2

**12-195 - 199**  
BREISKY  
WIENER MODELL/  
VIENNA PATTERN  
12-195 130 X 20 mm  
12-196 130 X 25 mm  
12-197 130 X 30 mm  
12-198 130 X 35 mm  
12-199 130 X 40 mm  
320 mm



1/2

**12-200 - 201**  
WEISSBARTH  
12-200 80 X 28 mm  
12-201 85 X 42 mm  
210 mm



1/2

**12-202**  
DOYEN  
lateral speculum  
80 x 30 mm  
250 mm



# Vaginal & Wound Retractor / Vaginal Specula



**12-203**  
SIMON  
115 X 22 mm  
275 mm



**12-204**  
AUVARD  
65 X 38 mm - 28 mm  
1,530 kg  
with fixed weight  
230 mm



**12-205 - 206**  
AUVARD  
12-205 75 X 42 mm  
(40 mm)  
12-206 105 X 43 mm  
(40 mm)  
with detachable wight  
230 mm



**12-207**  
MARTIN  
with hook shaped  
handle for hanging  
in weights  
270 mm

# Vaginal Speculas

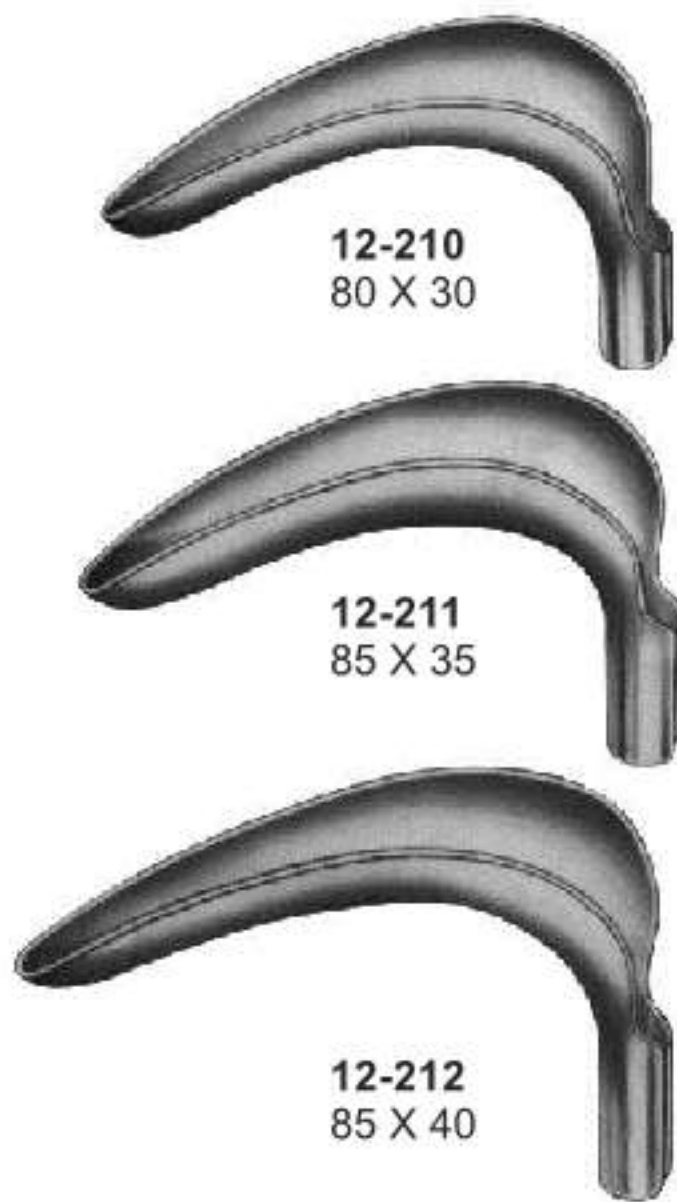

**12-210**  
80 X 30

**12-211**  
85 X 35

**12-212**  
85 X 40



**12-208**  
55 X 40 - 60 mm



**12-209**  
70 X 45 - 70 mm



**12-208 - 212**  
SCHERBACK  
Set consisting of:  
handle  
weight  
5 blades

1/5

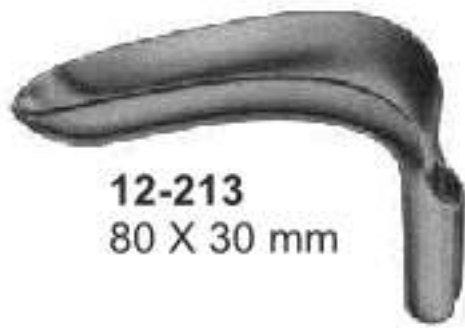

**12-213**  
80 X 30 mm



**12-217**  
65 X 30 mm



**12-214**  
85 X 33 mm



**12-218**  
75 X 35 mm

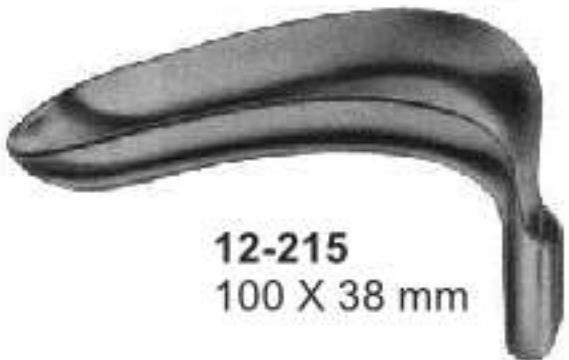

**12-215**  
100 X 38 mm

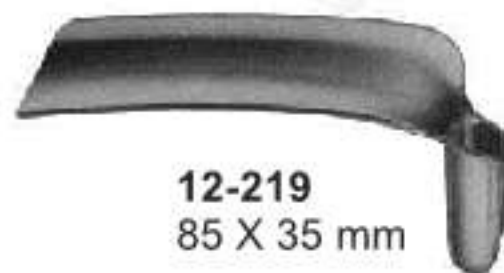

**12-219**  
85 X 35 mm



**12-216**  
110 X 42 mm



**12-220**  
95 X 35 mm



**12-213 - 220**  
SCHERBACK  
Set consisting of:  
2 handle  
8 blades

1/5

# Vaginal Retractors



12-221  
JOLL (FRIEDMAN)  
155 mm



12-222  
RICHTER  
170 mm



12-223  
GELPI  
135 mm



12-224  
GELPI  
175 mm

# Uterine Dilators



1/2

**13-101 - 143**  
HEGAR  
with very conical point  
185 mm

<b>13-101</b>	1	mm	<b>13-123</b>	23	mm
<b>13-102</b>	2	mm	<b>13-124</b>	24	mm
<b>13-103</b>	3	mm	<b>13-125</b>	25	mm
<b>13-104</b>	4	mm	<b>13-126</b>	26	mm
<b>13-105</b>	5	mm	<b>13-127</b>	1	1/2mm
<b>13-106</b>	6	mm	<b>13-128</b>	2	1/2mm
<b>13-107</b>	7	mm	<b>13-129</b>	3	1/2mm
<b>13-108</b>	8	mm	<b>13-130</b>	4	1/2mm
<b>13-109</b>	9	mm	<b>13-131</b>	5	1/2mm
<b>13-110</b>	10	mm	<b>13-132</b>	6	1/2mm
<b>13-111</b>	11	mm	<b>13-133</b>	7	1/2mm
<b>13-112</b>	12	mm	<b>13-134</b>	8	1/2mm
<b>13-113</b>	13	mm	<b>13-135</b>	9	1/2mm
<b>13-114</b>	14	mm	<b>13-136</b>	10	1/2mm
<b>13-115</b>	15	mm	<b>13-137</b>	11	1/2mm
<b>13-116</b>	16	mm	<b>13-138</b>	12	1/2mm
<b>13-117</b>	17	mm	<b>13-139</b>	13	1/2mm
<b>13-118</b>	18	mm	<b>13-140</b>	14	1/2mm
<b>13-119</b>	19	mm	<b>13-141</b>	15	1/2mm
<b>13-120</b>	20	mm	<b>13-142</b>	16	1/2mm
<b>13-121</b>	21	mm	<b>13-143</b>	17	1/2mm
<b>13-122</b>	22	mm			



1/2

**13-144 - 152**  
HEGAR  
205 mm

<b>13-144</b>	1+2	mm
<b>13-145</b>	3+4	mm
<b>13-146</b>	5+6	mm
<b>13-147</b>	7+8	mm
<b>13-148</b>	9+10	mm
<b>13-149</b>	11+12	mm
<b>13-150</b>	13+14	mm
<b>13-151</b>	15+16	mm
<b>13-152</b>	17+18	mm

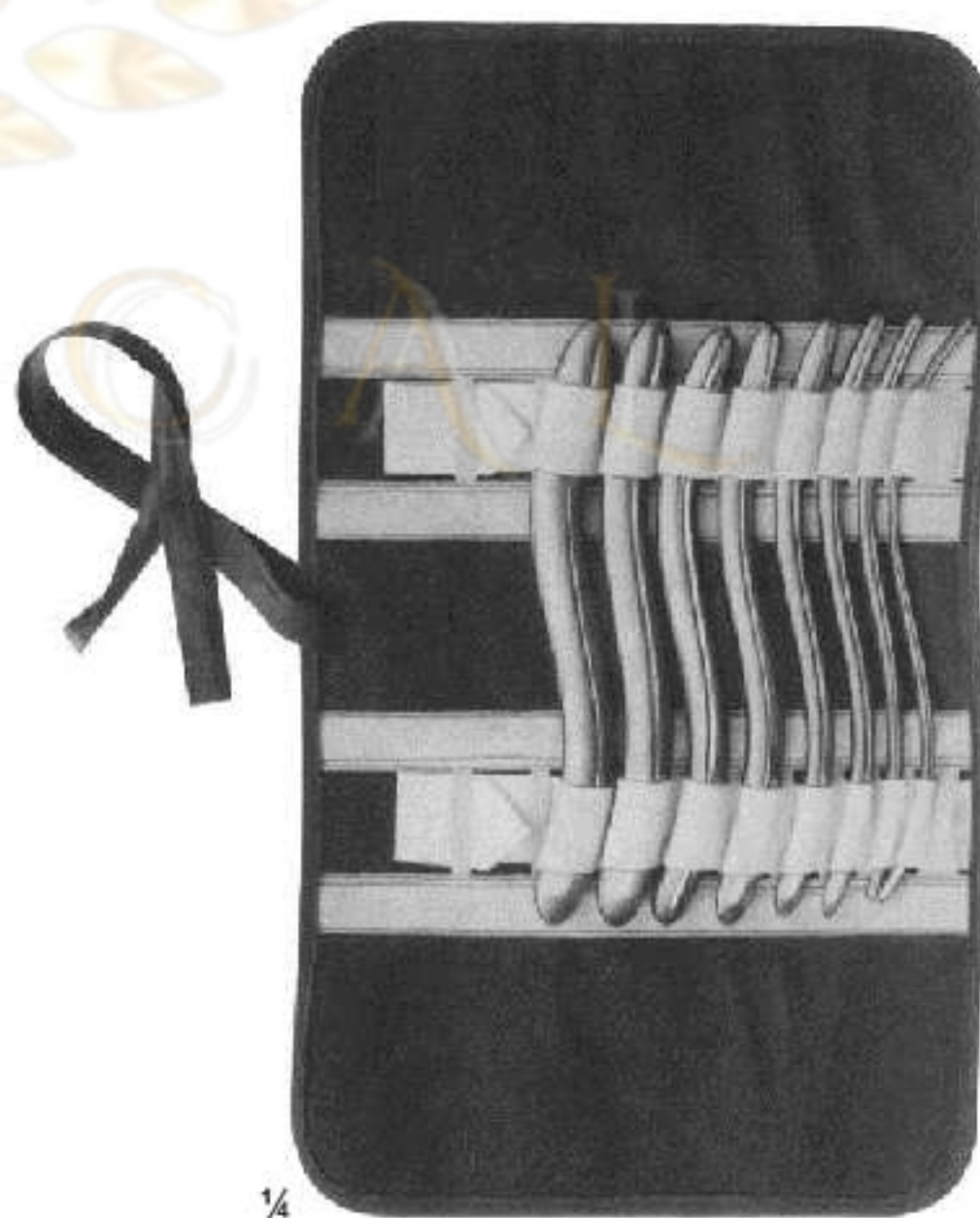

1/4

**13-153**  
HEGAR  
Uterine dilator set, in canvas  
roll with 8 dilators.

## Uterine Dilators - Complete Sets



**13-154**  
HEGAR  
Dilator set consisting of:  
14 Dilators,  
1 Rack for dilators ( 4 - 12 mm )  
1 Rack for Dilators ( 13 - 17 mm )  
1 Metal case only,  
with hinged lid, stainless 200 X 100 X 35 mm

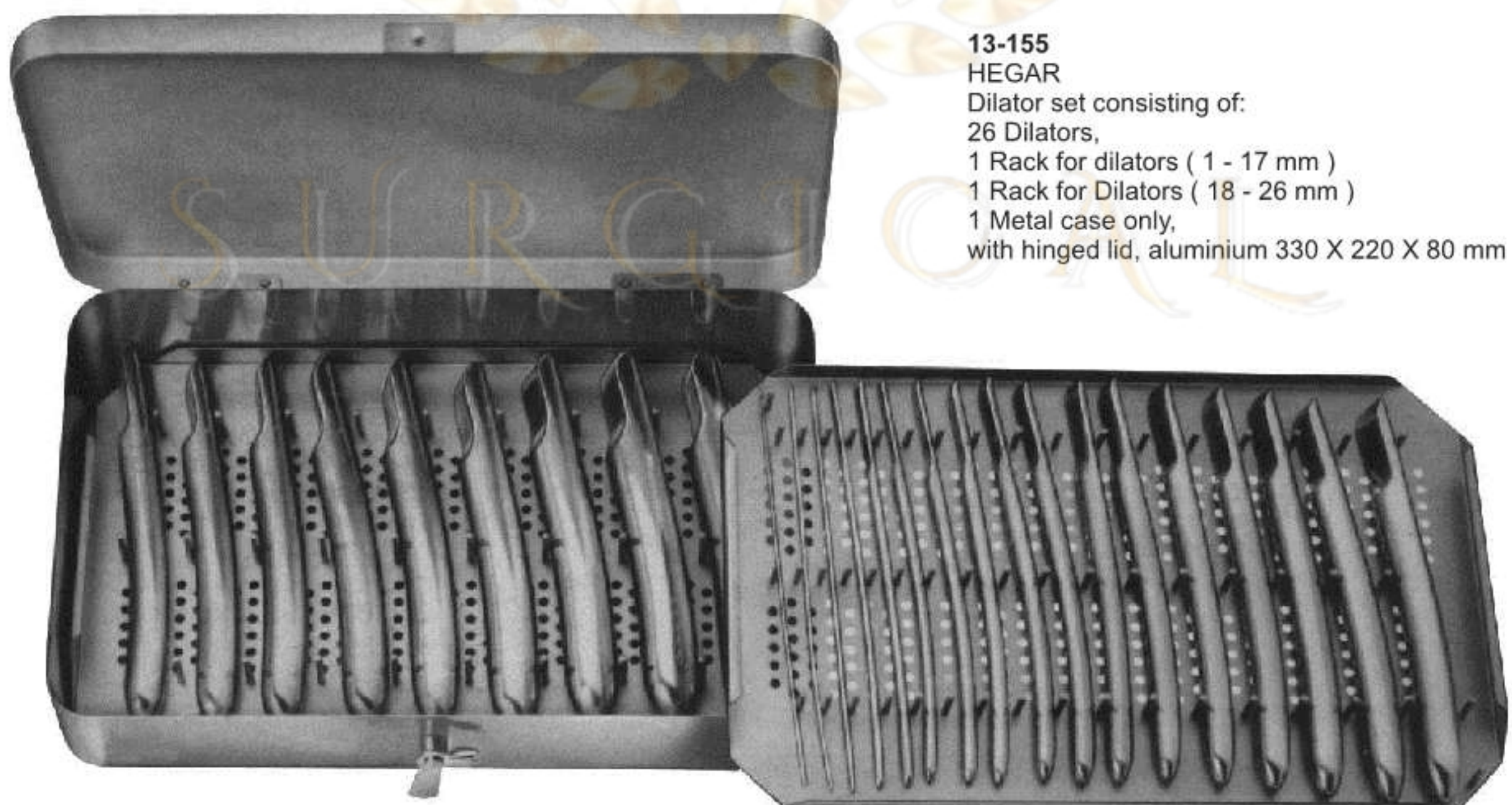

**13-155**  
HEGAR  
Dilator set consisting of:  
26 Dilators,  
1 Rack for dilators ( 1 - 17 mm )  
1 Rack for Dilators ( 18 - 26 mm )  
1 Metal case only,  
with hinged lid, aluminium 330 X 220 X 80 mm



**13-156**  
KOGAN  
Endospecula for cervix  
and urethra, without ratchet  
240 mm

**13-157**  
KOGAN  
Endospecula for cervix  
and urethra, with  
scale-ratchet and fixing screws  
240 mm

# Uterine Probes



# Uterine Dressing Forceps



14-107  
PELKMANN  
260 mm

14-108  
PELKMANN  
260 mm

14-109  
BOZEMANN  
250 mm

14-110  
BOZEMANN  
255 mm

Jaws with longitudinal groove



# Uterine Dressing Forceps



# Uterine Tenaculum Forceps

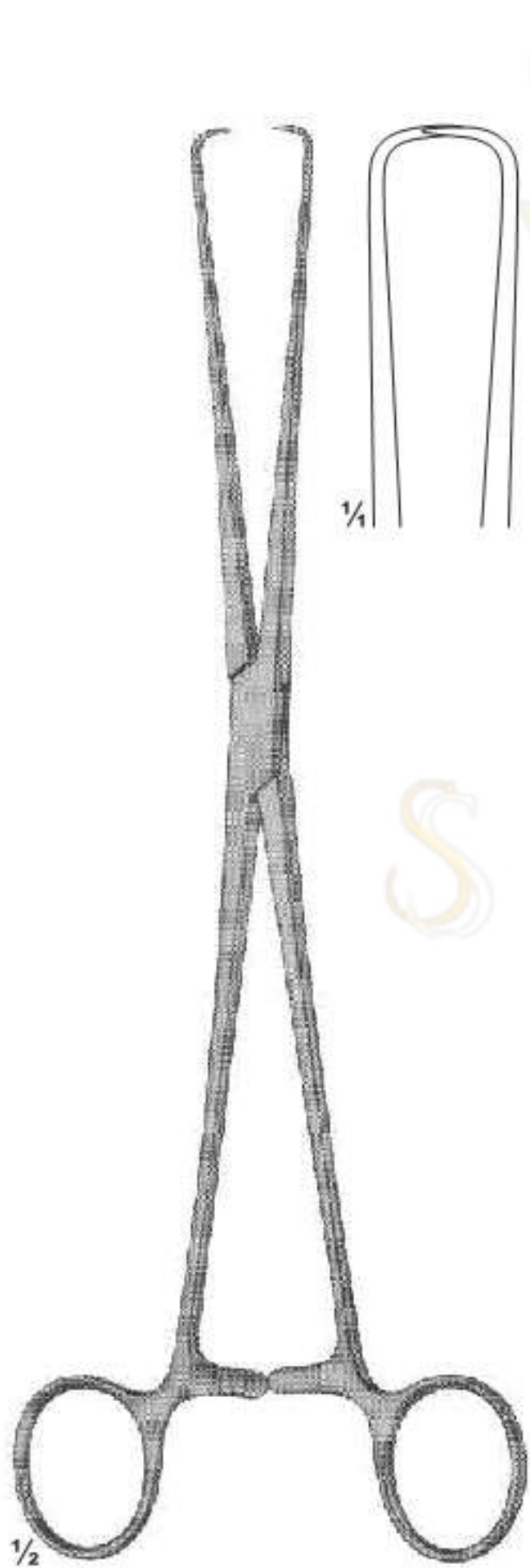

**14-114**  
BRAUN  
slender type  
250 mm



**14-115**  
SCHRODER  
250 mm

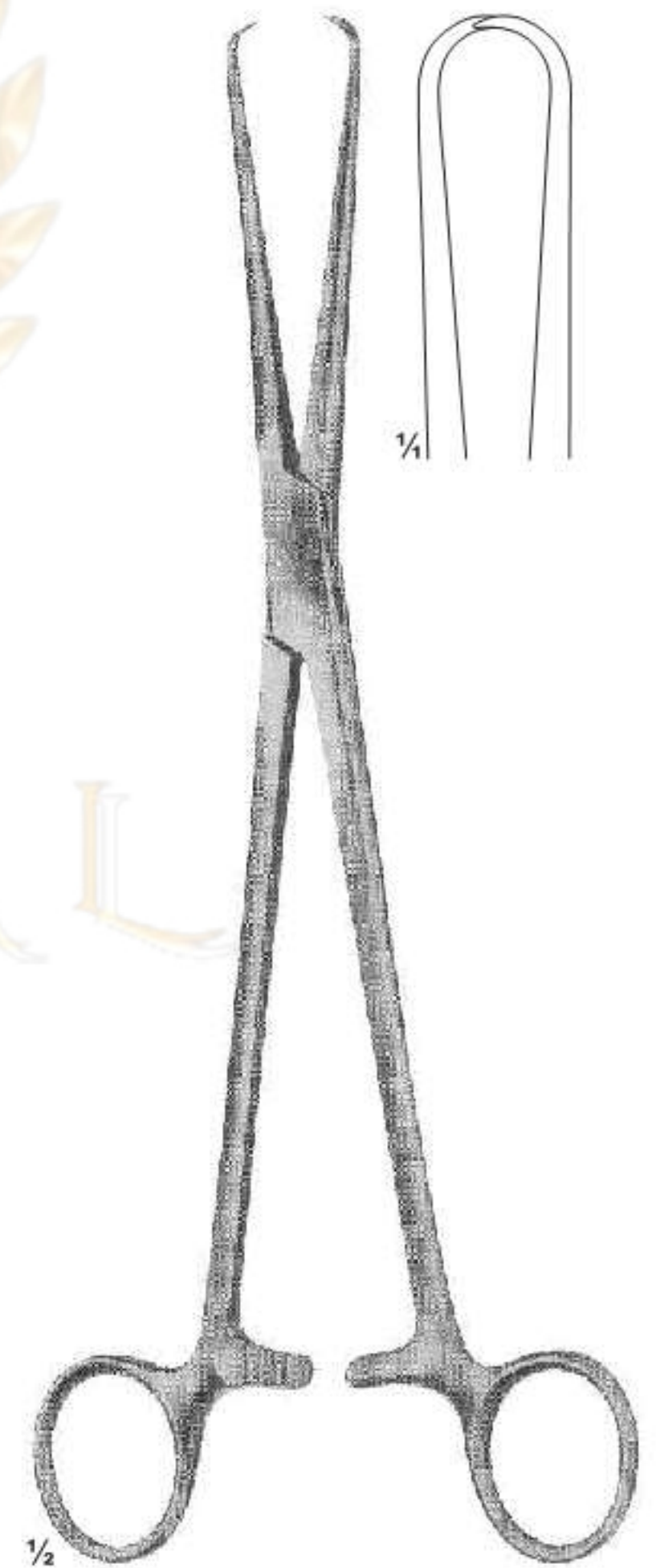

**14-116**  
POZZI  
heavy type  
255 mm

# Uterine Tenaculum Forceps

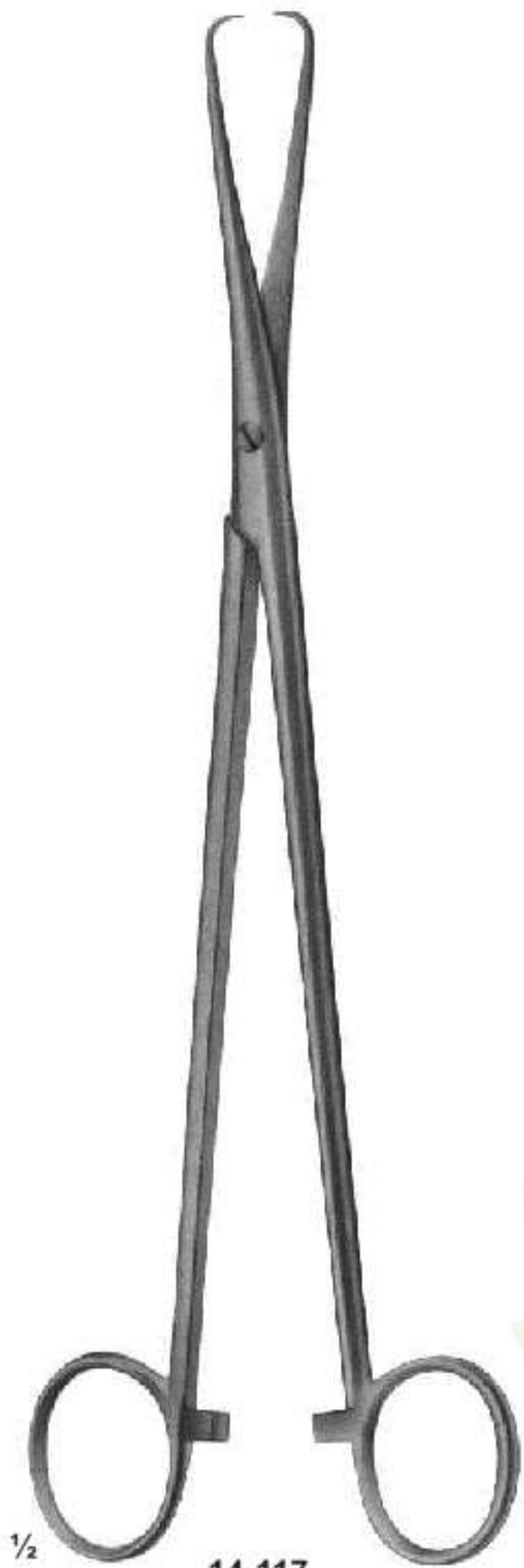

**14-117**  
265 mm



**14-118**  
DUPLAY  
250 mm

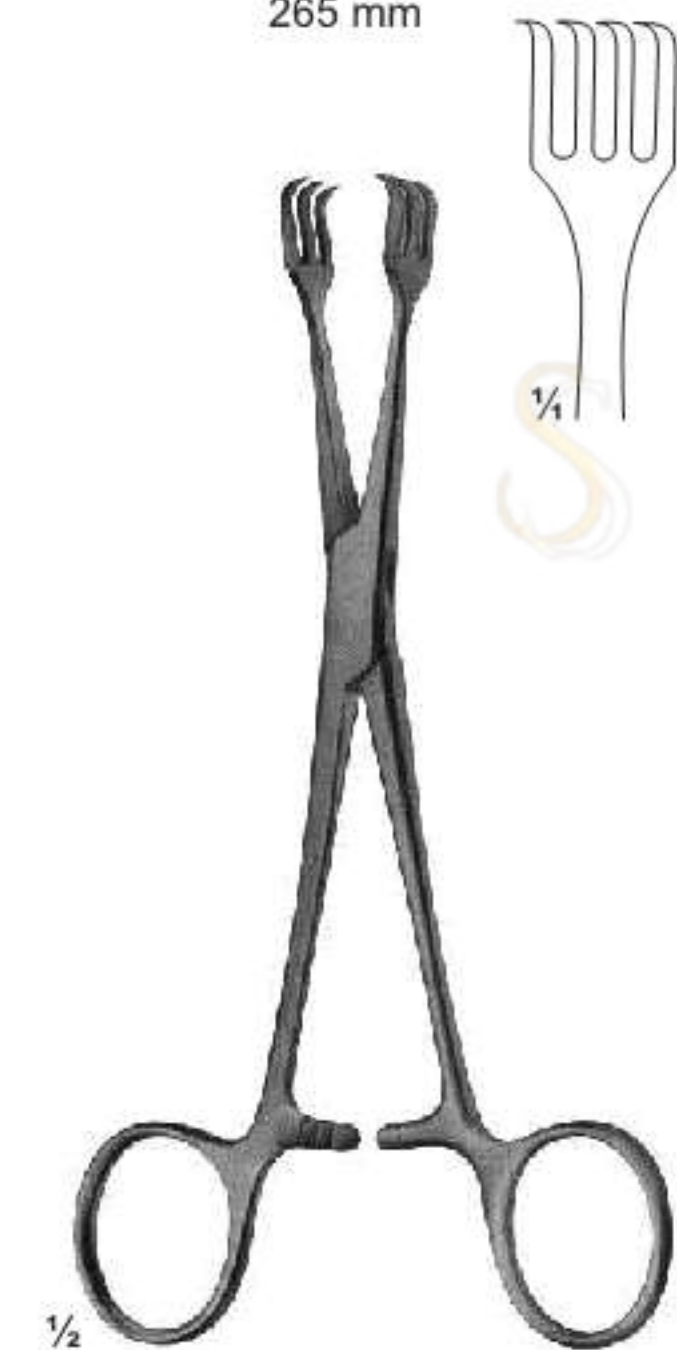
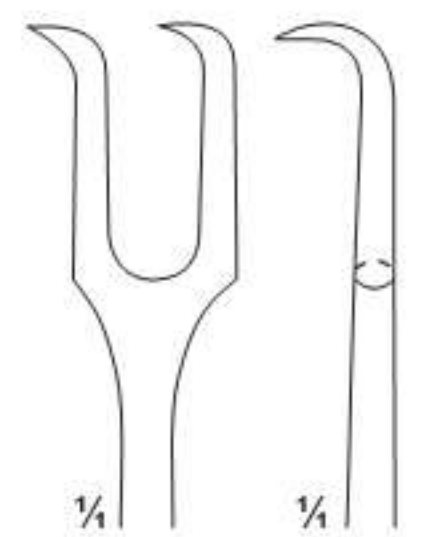

**14-119**  
LAHEY  
155 mm



**14-120**  
straight

**14-121**  
curved  
on flat

**14-122**  
curved  
sideways

**14-120 - 122**  
SCHRODER  
250 mm

# Uterine Tenaculum Forceps

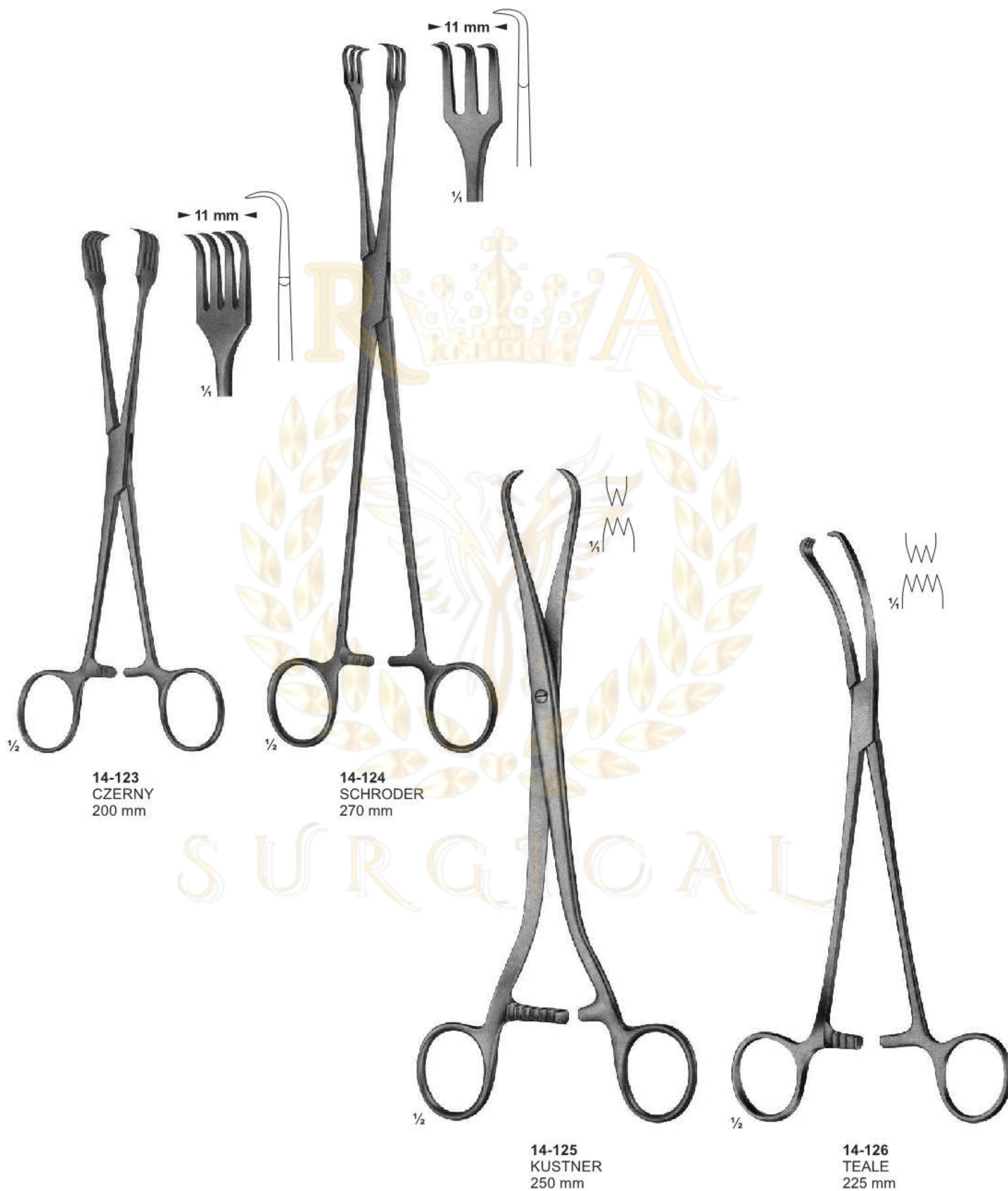

# Uterine Tenaculum Forceps



**14-127  
JACOBS**  
215 mm



**14-128  
LITTLEWOOD**  
185 mm



**14-129  
MUSEUX**  
200 mm

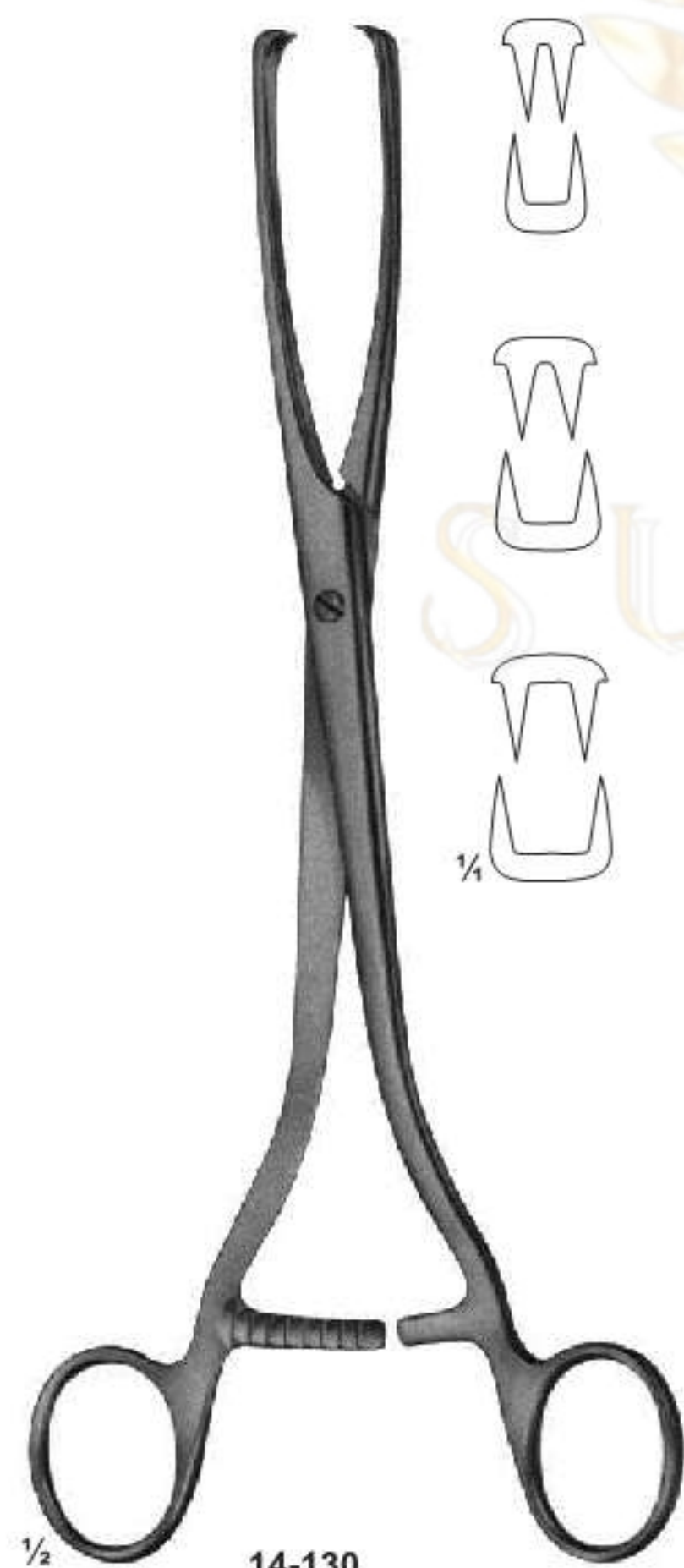

**14-130  
MUSEUX**  
240 mm



**14-131  
MUSEUX**  
Curved sideways  
240 mm

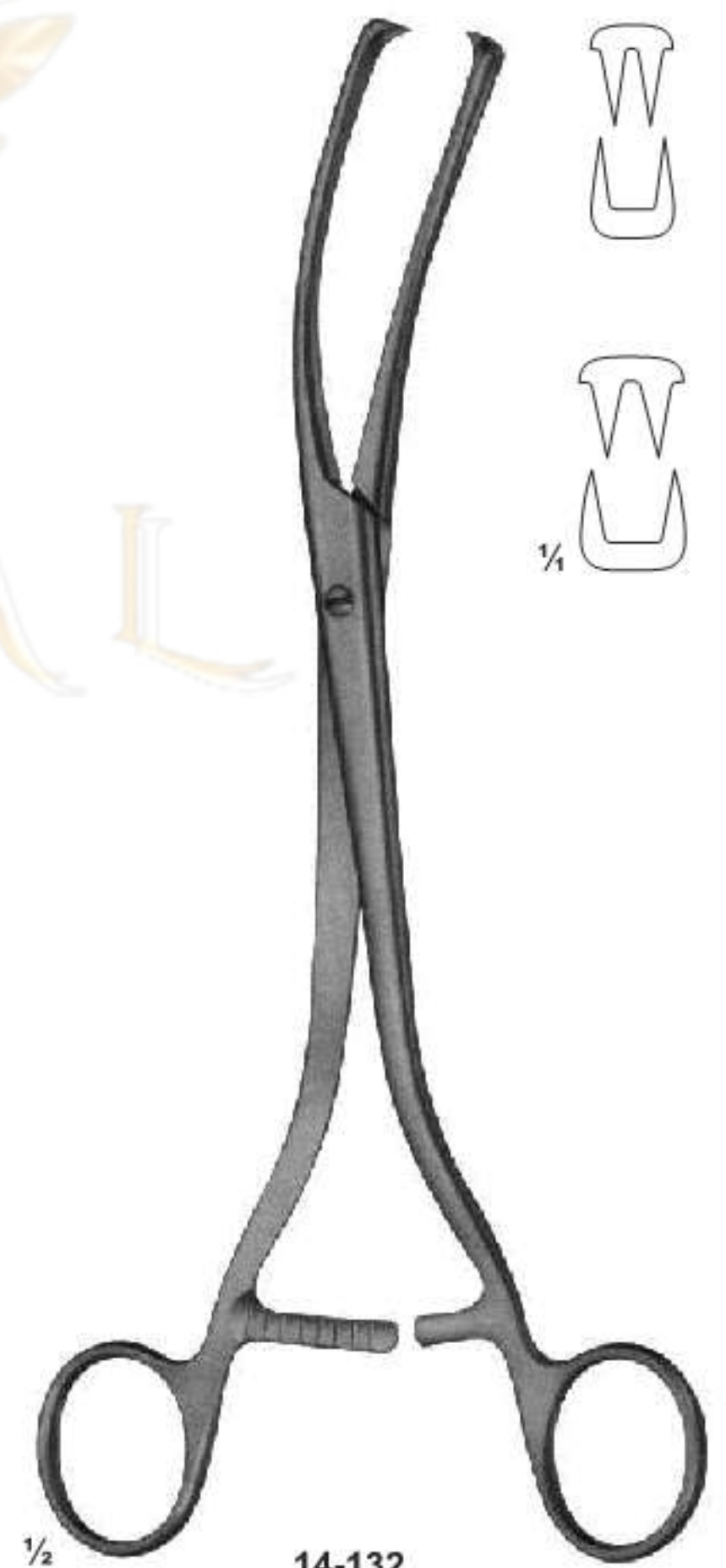

**14-132  
MUSEUX**  
240 mm

# Polypus-and Ovum Forceps



14-133  
HEYWOOD-SMITH  
200 mm

14-134  
KELLY  
320 mm

14-135  
HEYWOOD-SMITH  
250 mm

14-136  
NOTO  
280 mm

# Polypus and Ovum Forceps



14-137  
DOYEN  
185 mm



14-138 - 139  
250 mm 270 mm



14-140  
BUMM  
280 mm

# Uterine Elevating Forceps



14-141  
COLLIN  
250 mm

14-142  
COLLIN  
285 mm

14-143  
DARTIGUES  
255 mm



# Uterine Elevating Forceps



**14-144**  
SOMER  
235 mm



**14-145**  
STRASSMANN  
260 mm

# Uterine Elevating Forceps



With movable jaws

14-146  
COLLIN  
265 mm

With movable jaws



14-147  
260 mm

# Myoma Instruments



**14-148**  
SEGOND  
Myomatome  
270 mm



**14-149**  
DOYEN  
Myoma screw  
150 mm



**14-150**  
DOYEN  
Myoma screw  
190 mm



**14-151**   **14-152**   **14-153**

**14-151 - 153**  
NEUBUSER  
Tubal seizing forceps  
200 mm



**14-154**  
Splint guide  
with thread



**14-155**  
Splint guide with  
round handle  
180 mm



**14-156**  
Angled glass rods  
Set . 3 pieces



145 X 100 X 1.5 mm

**14-157**  
Silicon operating pad  
pre-cut



**14-158**  
Polyaethylen splint material  
soft-sterile  
0.45 mm

# Biopsy Currettes



**15-101**  
ASCH  
Uterine  
Secretion scoop  
200 mm

**15-102**  
Uterine  
Secretion scoop  
270 mm

**15-103**  
NOVAK-SCHOECKAERT  
Endometrial biopsy  
curette  
240 mm

**15-104**  
RANDALL  
Endometrial biopsy  
curette  
240 mm

# Biopsy Forceps

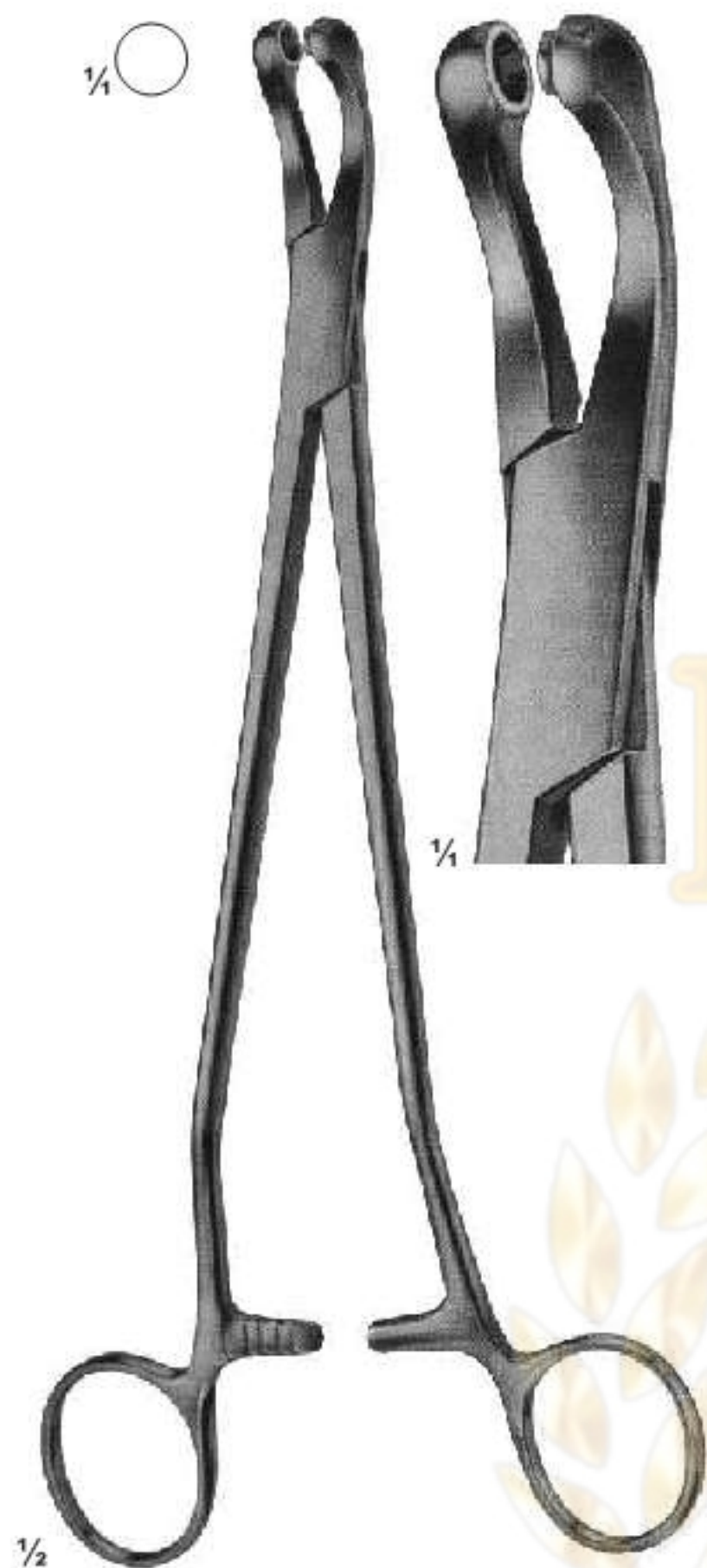

**15-105**  
THOMS-GAYLOR  
240 mm



**15-106**  
SCHUBERT  
260 mm



**15-107**  
FAURE  
210 mm



**15-108**  
FAURE  
240 mm

# Biopsy Forceps

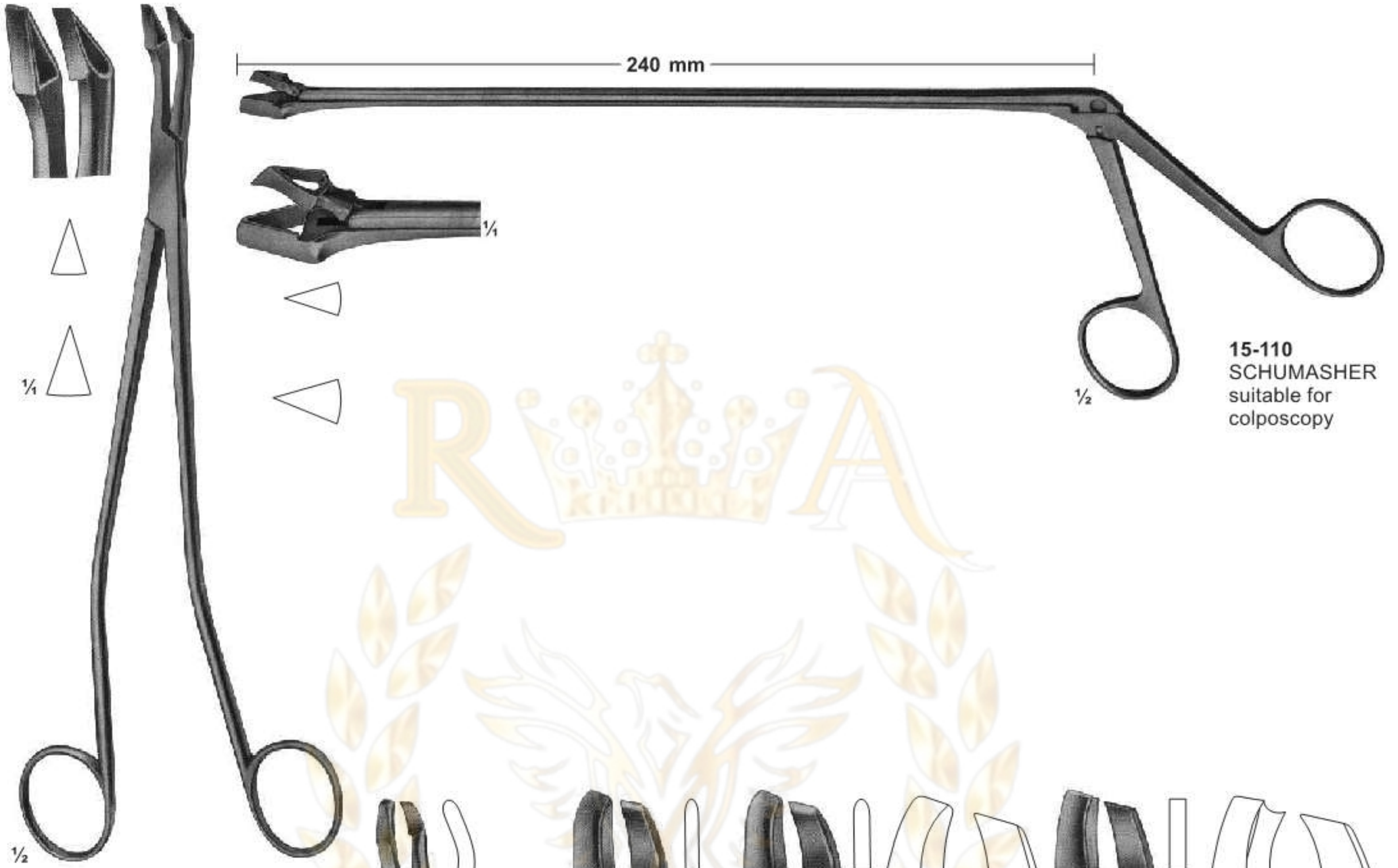

**15-110**  
SCHUMASHER  
suitable for  
colposcopy

**15-109**  
SCHUMASHER  
240mm

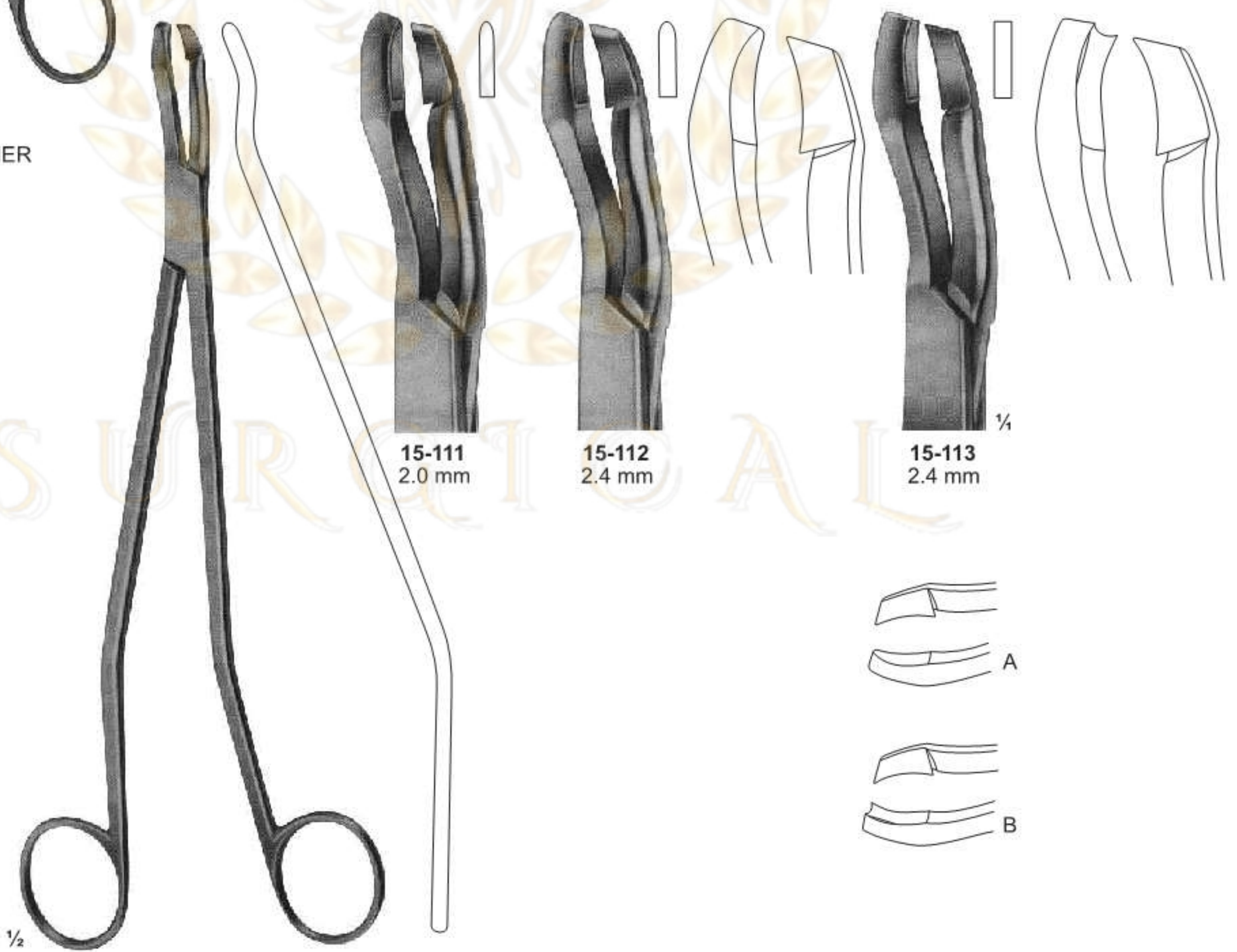

**15-111**  
2.0 mm

**15-112**  
2.4 mm

**15-113**  
2.4 mm

**15-111 - 113**  
SEIDL DBP  
Biopsy forceps, bayonet shaped  
for portio, vagina and vulva  
240mm

# Biopsy Forceps

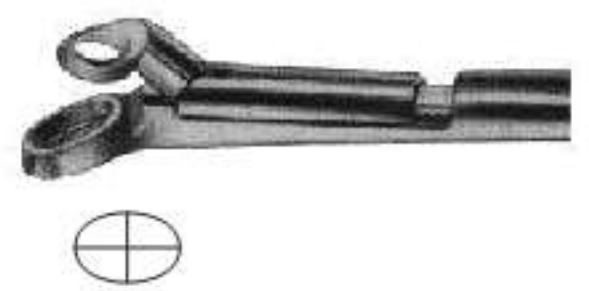
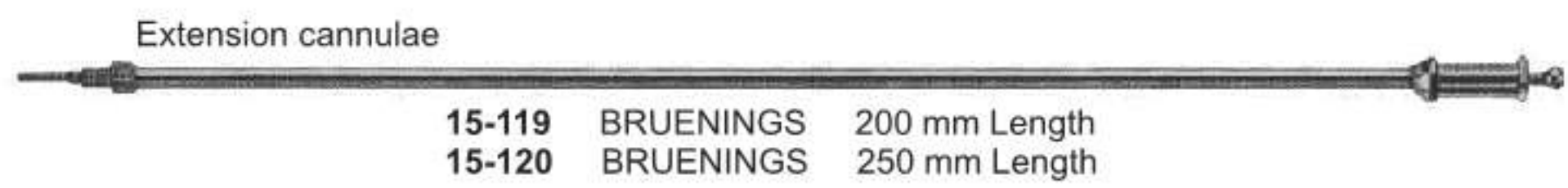
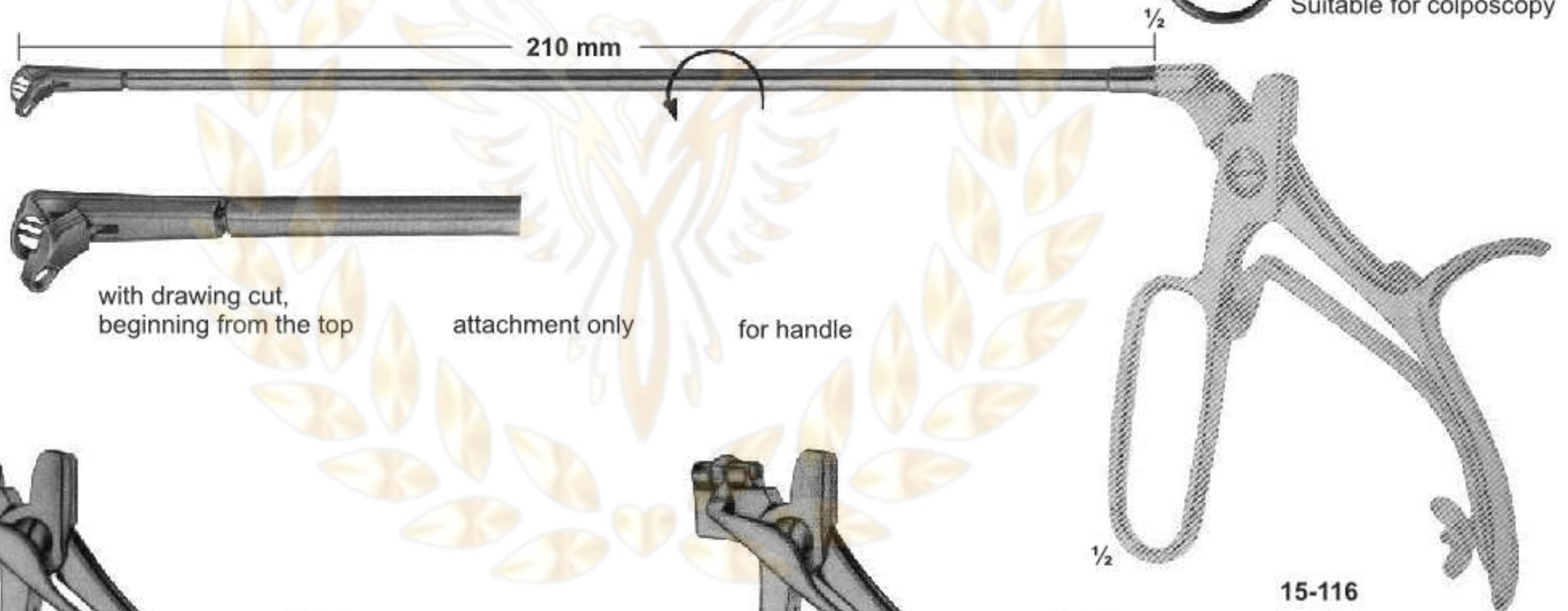
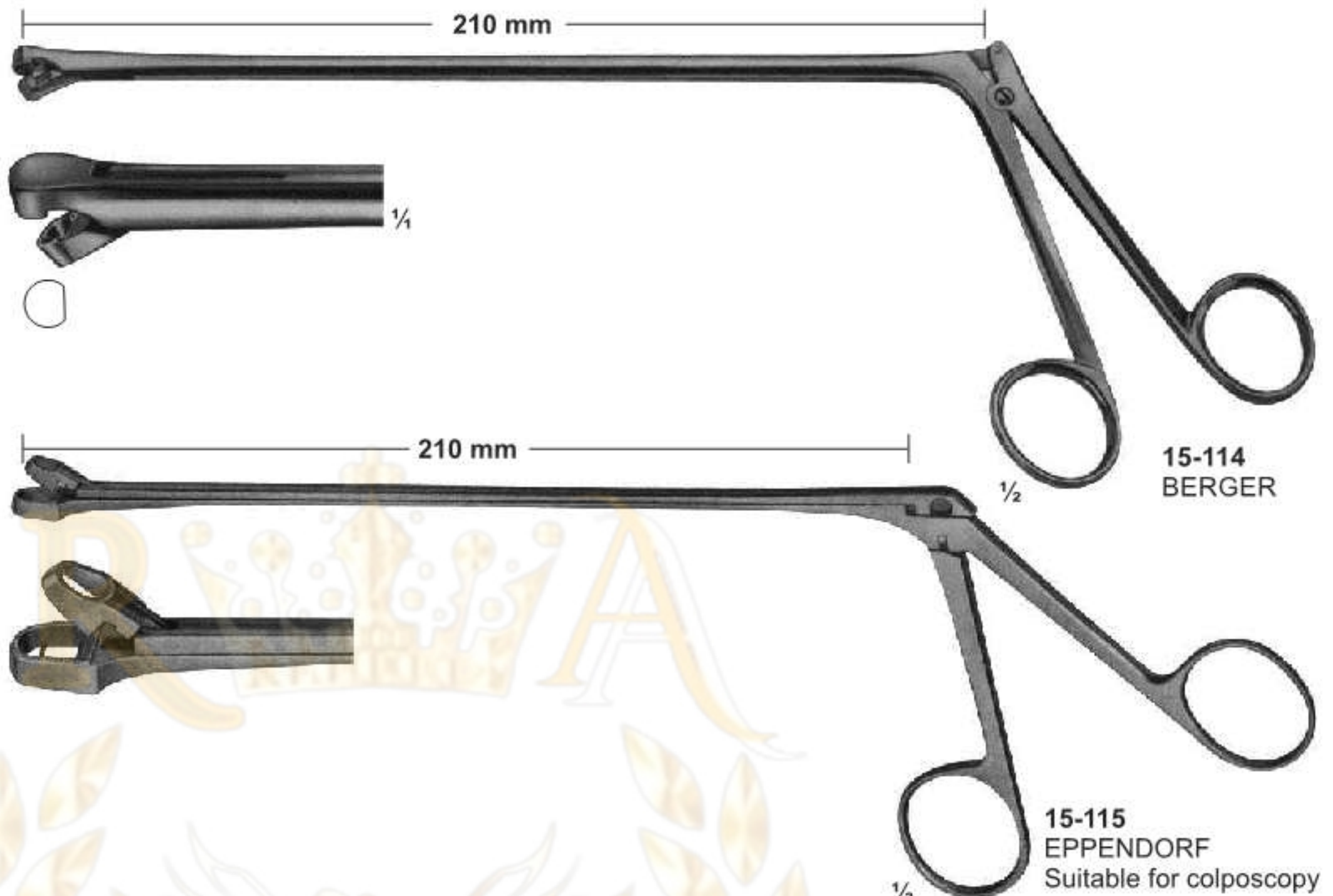

15-121 KRAUSE ( Biopsy tip )

15-122 SCHEINMANN ( Biopsy tip )

15-123 SCHEINMANN ( Biopsy tip )  
with drawing cut

# Uterine Scoops

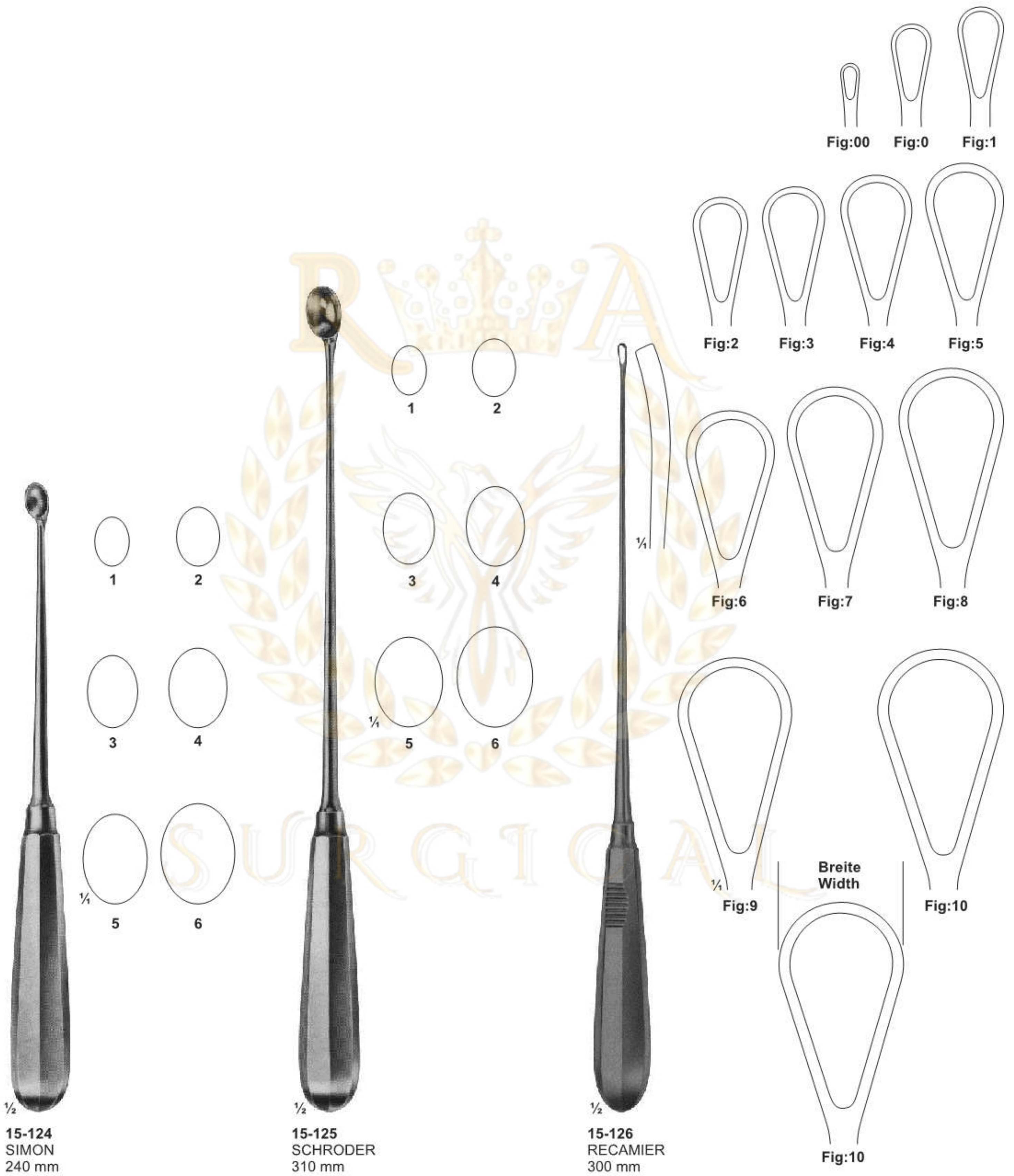

15-124  
SIMON  
240 mm

15-125  
SCHRODER  
310 mm

15-126  
RECAMIER  
300 mm



# Uterine Curettes



# Placenta-and Ovum Curettes



**15-130**  
COLLIN  
300 mm



**15-131**  
RECAMIER  
blunt-rigid  
360 mm



Fig:1



Fig:2



**15-132**  
BUMM  
310 mm

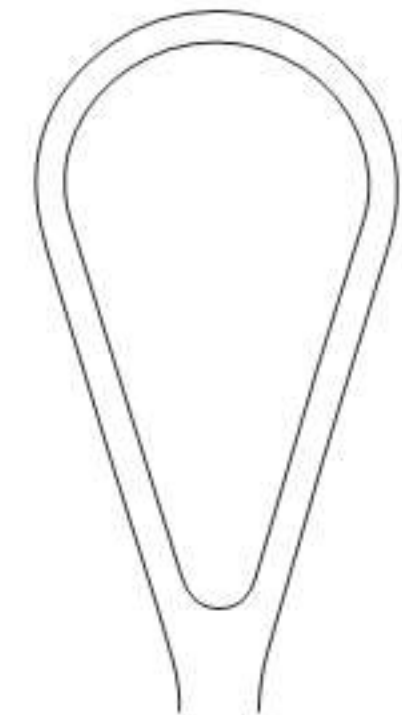

Fig:1

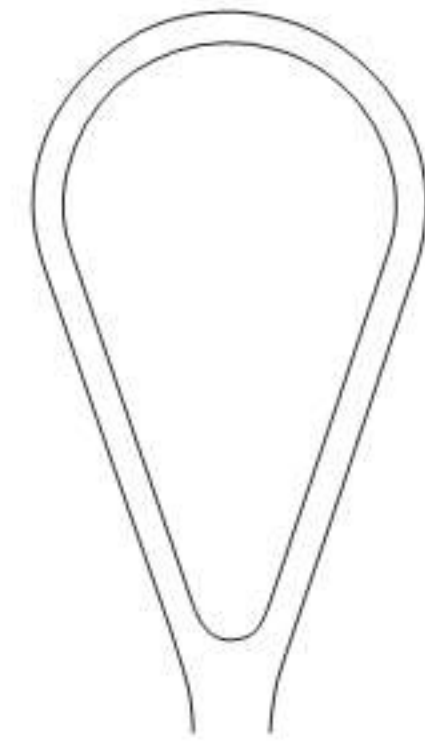

Fig:2

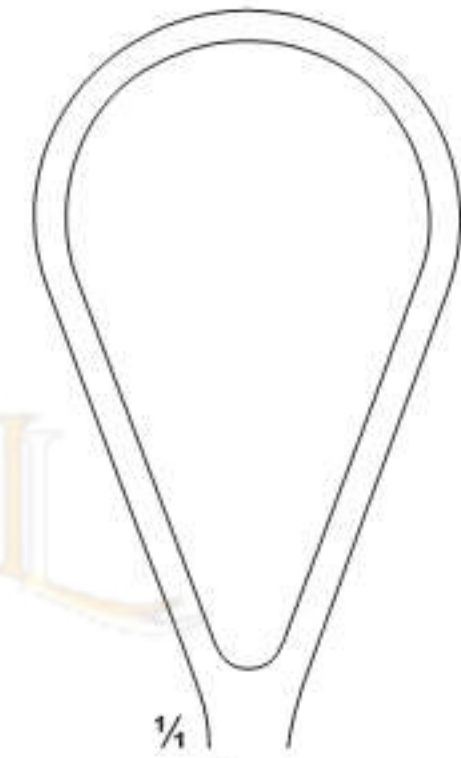

Fig:3

# Vacuum Currettes



## 15-133 - 138

Suction currettes, stainless steel, fitting hose connection.

Working tips are smoothly rounded of, therefore no danger of perforation.



( suitable for suction biopsy )

- 15-133: diam 4 mm
- 15-134: diam 6 mm
- 15-135: diam 8 mm
- 15-136: diam 10 mm
- 15-137: diam 12 mm
- 15-138: diam 14 mm

## 15-139

Hose connection inside diam. 11 mm curved stainless steel.



## 15-140

The new connection between suction currette and hose connection, Guarantees quick changing and free turning of the suction currettes on the hose connection.

## 15-141

Transparent suction hose 1.8 m long, inside diam 11 mm, outside diam 16.5 mm can be sterilized in an autoclave at 1 bar overpressure ( 120 C )



## 15-142

Strainer for tissues, plastic, for single use only, to be used for histopathological examination.



15-143 diam 8 mm  
15-144 diam 10 mm  
BOZEMANN-FRITSCH  
Uterine Flushing Tube  
350 mm

15-145  
SCHULZE  
Salpingograph, for utero-salpingography  
in wooden case, consisting of:  
Manometer, Connection, Uterine canulla  
with tap, Cone S.M.L,  
Record Syringe 10 cc, Luer lock mount.



15-146  
SCHULZE  
Salpingograph, equipment  
without manometer.



# Obstetrics-Pelvimeters



**16-101**  
THOLE  
for internal and external measurements, graduated in centimeters

1/3

1/2

1/3

1/3

**16-102**  
DE LEE  
graduated in centimeters and inches

**16-103**  
COLLIN  
graduated in centimeters

**16-104**  
MARTIN  
graduated in centimeters

for internal measurements between symphysis and promontory

**16-105**  
COLLIN  
graduated in centimeters

The additional straight arm can be replaced. The pelvimeter with straight arm is used for localisation of the portio vaginalis uteri and of vaginal metastasis.

**16-106**  
BREISKY  
graduated in centimeters

1/3

1/3



**16-107**  
HERFF  
puncturing forceps  
225 mm



**16-108**  
IOWA  
puncturing forceps  
260 mm

# Scissors of Obstetrics, Umbilical cord clamp



**16-109**  
SCHUMACHER  
Umbilical cord  
scissors  
155 mm



**16-110**  
Umbilical cord  
scissors  
105 mm



**16-111 - 112**  
BRAUN-STADLER  
Episiotomy Scissors

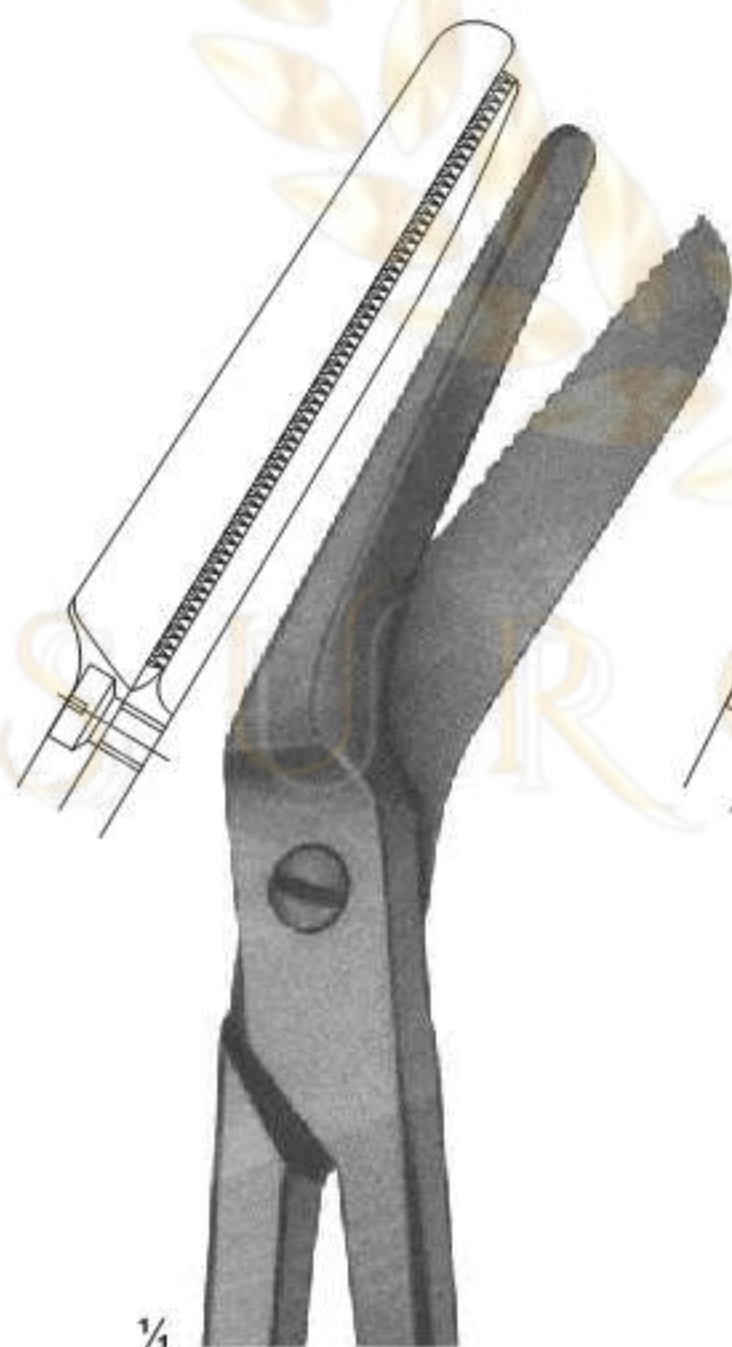

**16-111**  
145 mm



**16-112**  
200 mm

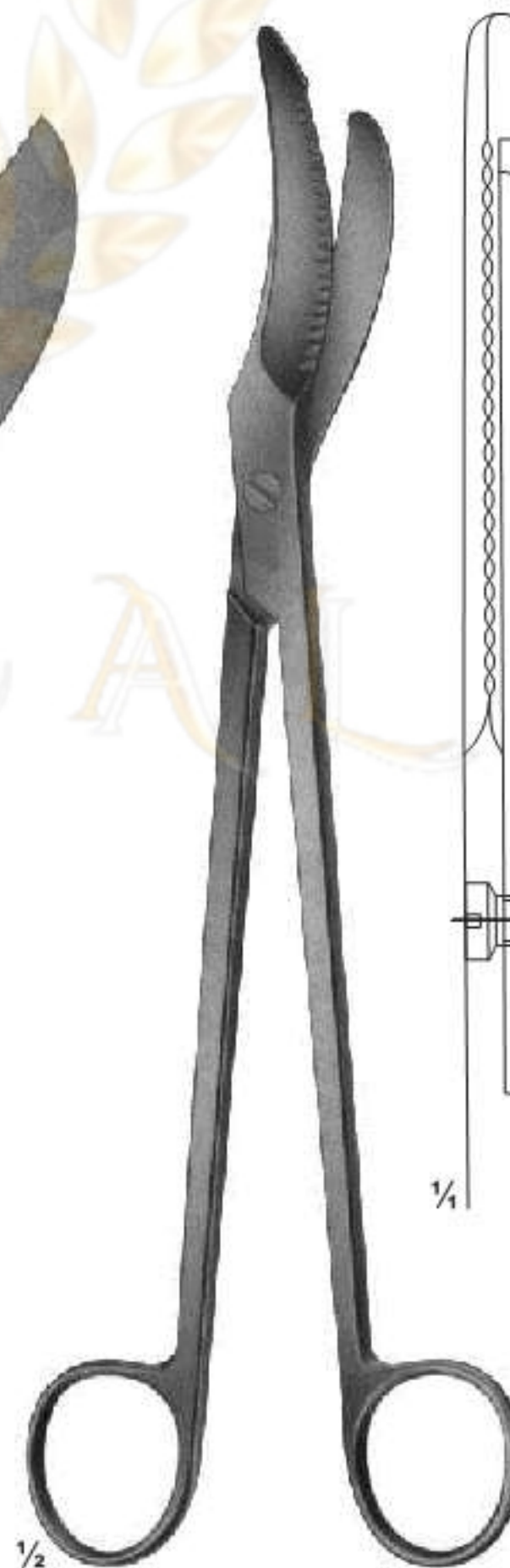

**16-113**  
Episiotomy Scissors  
240 mm

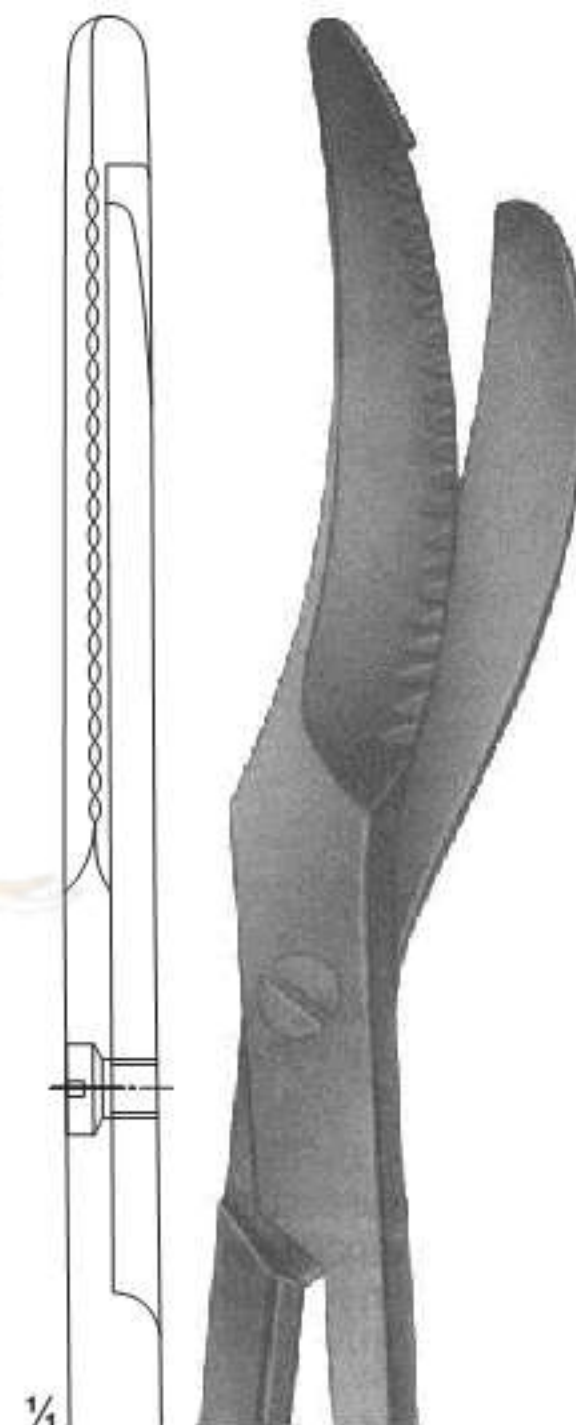



1/3

**16-114**  
355 mm



1/3

**16-115**  
400 mm



1/3

**16-116**  
SIMPSON-BRAUN  
305mm





**16-117**  
SIMPSON-BRAUN  
305mm



**16-118**  
SIMPSON  
235mm

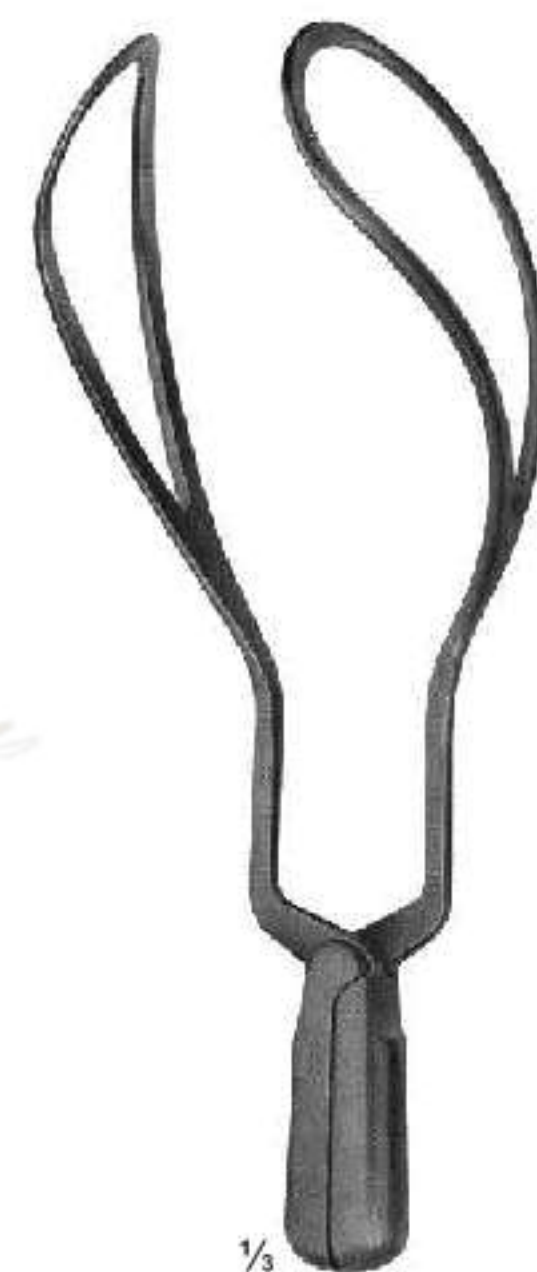

**16-119**  
WRIGLEY  
250 mm



**16-120**  
**GREEN-ARMYTAGE**  
Caesarean section haemostatic  
forceps, for edges of the transverse  
incision in the lower segment  
220 mm

**16-121**  
**WILLETT**  
Scalpel Flap forceps  
185 mm

**16-122**  
**GAUSS**  
Scalpel Flap forceps  
260 mm

# Obstetrics-Placenta and Ovum Forceps



# Obstetrics-Placenta and Ovum Forceps

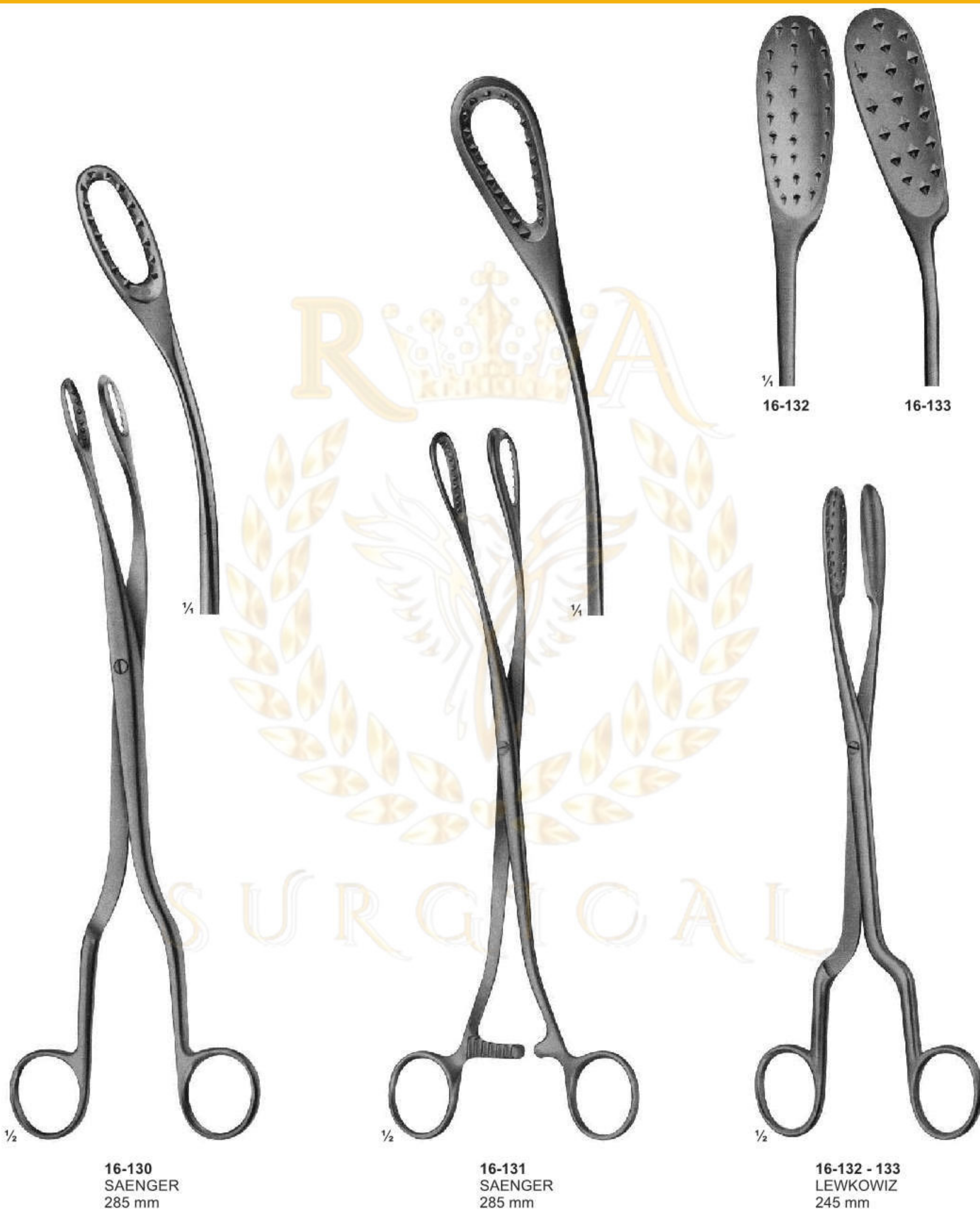

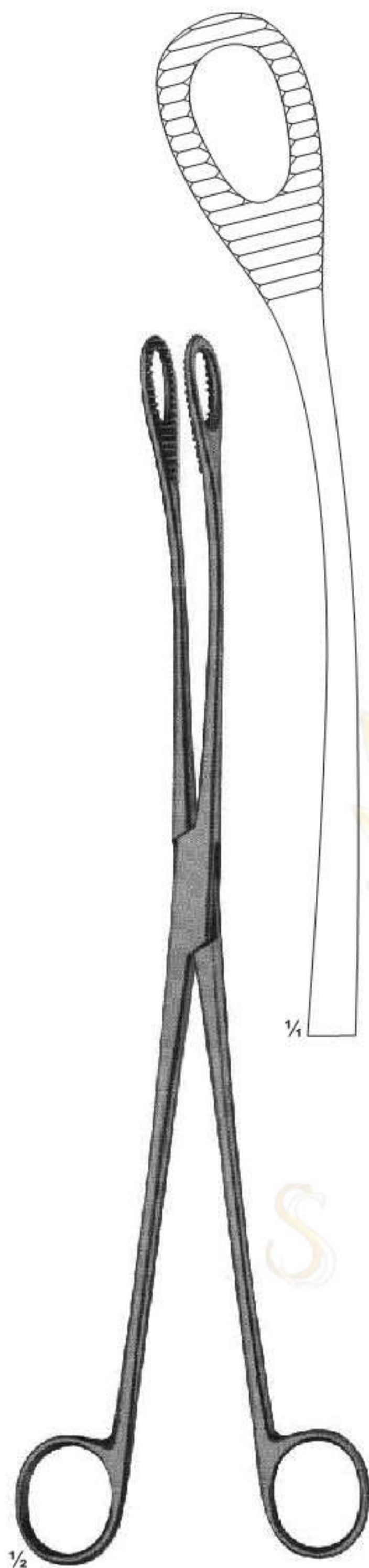

16-134  
KELLY  
320mm



16-135  
SMELLIE  
Perforator  
270mm



16-136  
BRAUN  
Cranioclast  
420mm

# Tracheal Tubes with inner tubes



1/2

**16-137**  
UECKERMANN-DENKER  
Cryothyrotomy trocar  
with silver cannula  
130mm

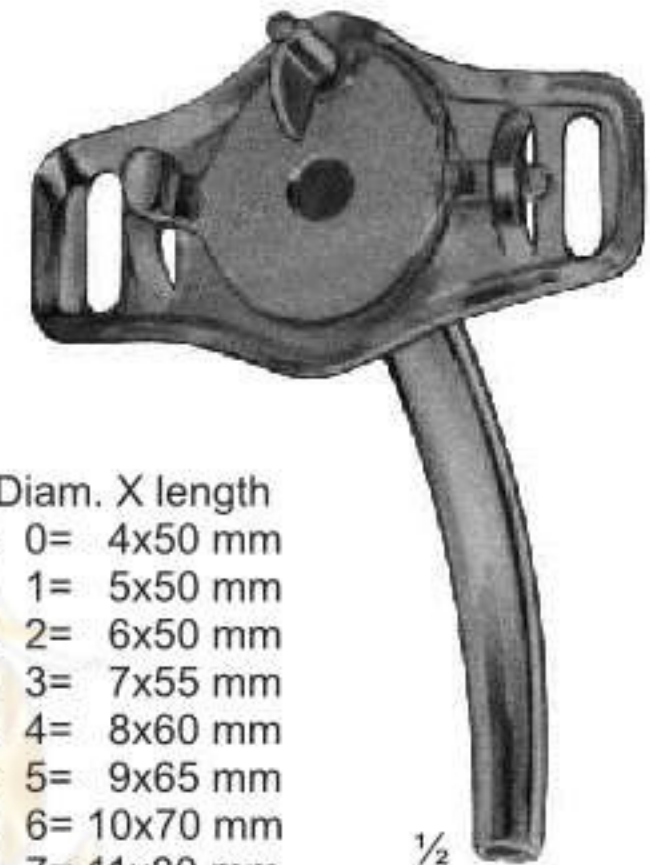

1/2

**16-138 - 148**  
LUER  
German silver

	Diam. X length
<b>16-138</b> Fig. 0=	4x50 mm
<b>16-139</b> Fig. 1=	5x50 mm
<b>16-140</b> Fig. 2=	6x50 mm
<b>16-141</b> Fig. 3=	7x55 mm
<b>16-142</b> Fig. 4=	8x60 mm
<b>16-143</b> Fig. 5=	9x65 mm
<b>16-144</b> Fig. 6=	10x70 mm
<b>16-145</b> Fig. 7=	11x80 mm
<b>16-146</b> Fig. 8=	12x85 mm
<b>16-147</b> Fig. 9=	13x90 mm
<b>16-148</b> Fig. 10=	14x90 mm



1/2

**16-149 - 158**  
JACKSON  
German Silver



	Diam. X length
<b>16-149</b> Fig. 0=	4x50 mm
<b>16-150</b> Fig. 1=	5x58 mm
<b>16-151</b> Fig. 2=	6x58 mm
<b>16-152</b> Fig. 3=	7x70 mm
<b>16-153</b> Fig. 4=	8x78 mm
<b>16-154</b> Fig. 5=	9x84 mm
<b>16-155</b> Fig. 6=	10x84 mm
<b>16-156</b> Fig. 7=	11x86 mm
<b>16-157</b> Fig. 8=	12x88 mm
<b>16-158</b> Fig. 9=	13x90 mm



1/2

	Diam. X length
<b>16-159</b> Fig. 1=	5x48 mm
<b>16-160</b> Fig. 2=	6x58 mm
<b>16-161</b> Fig. 3=	7x70 mm
<b>16-162</b> Fig. 4=	8x78 mm
<b>16-163</b> Fig. 5=	9x84 mm
<b>16-164</b> Fig. 6=	10x84 mm
<b>16-165</b> Fig. 7=	11x86 mm
<b>16-166</b> Fig. 8=	12x88 mm
<b>16-167</b> Fig. 9=	13x90 mm
<b>16-168</b> Fig. 10=	14x90 mm

**16-159 - 168**  
JACKSON  
German Silver

# Tound-and Tracheal Hooks and Dilators



**16-169**  
BOSE  
165 mm



**16-170**  
BOSE  
165 mm



**16-171 - 173**  
180 mm



**16-171**  
sharp



**16-172**  
blunt



**16-173**  
stumpf/blunt

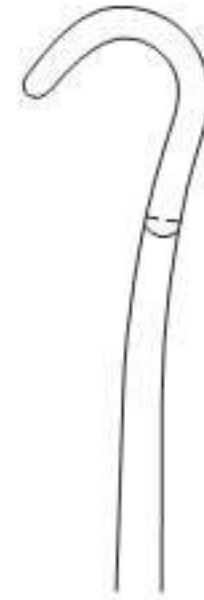

**16-174**  
FINSEN  
50 mm



**16-175**  
FINSEN  
70 mm



**16-176**  
TROUSSEAU  
120 mm



**16-177**  
LABORDE  
125 mm

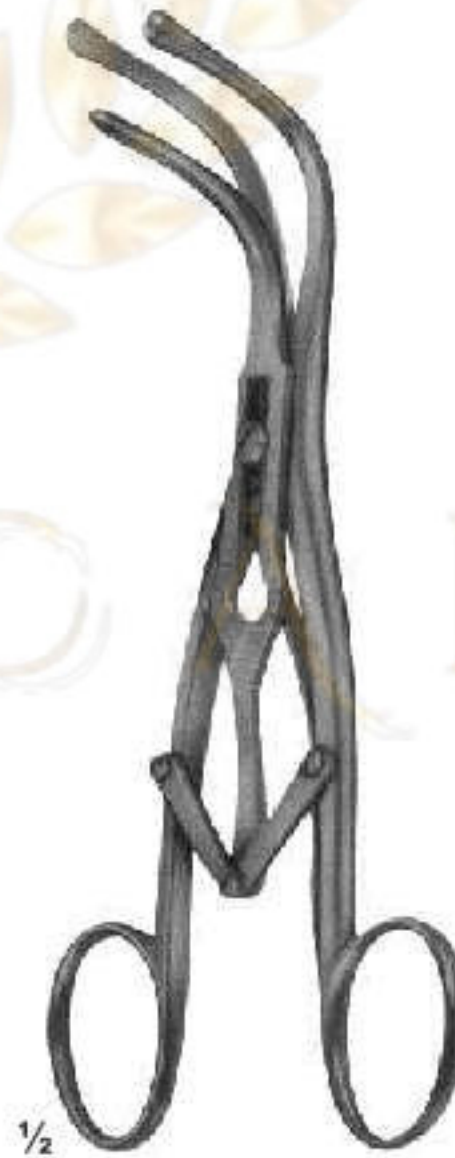

**16-178**  
LABORDE  
strong pattern  
135 mm



**16-179**  
Cleaning Brush  
for tracheal tubes  
285 mm

# Irrigating Cannulae, Embolus Grasping Forceps, Dilators

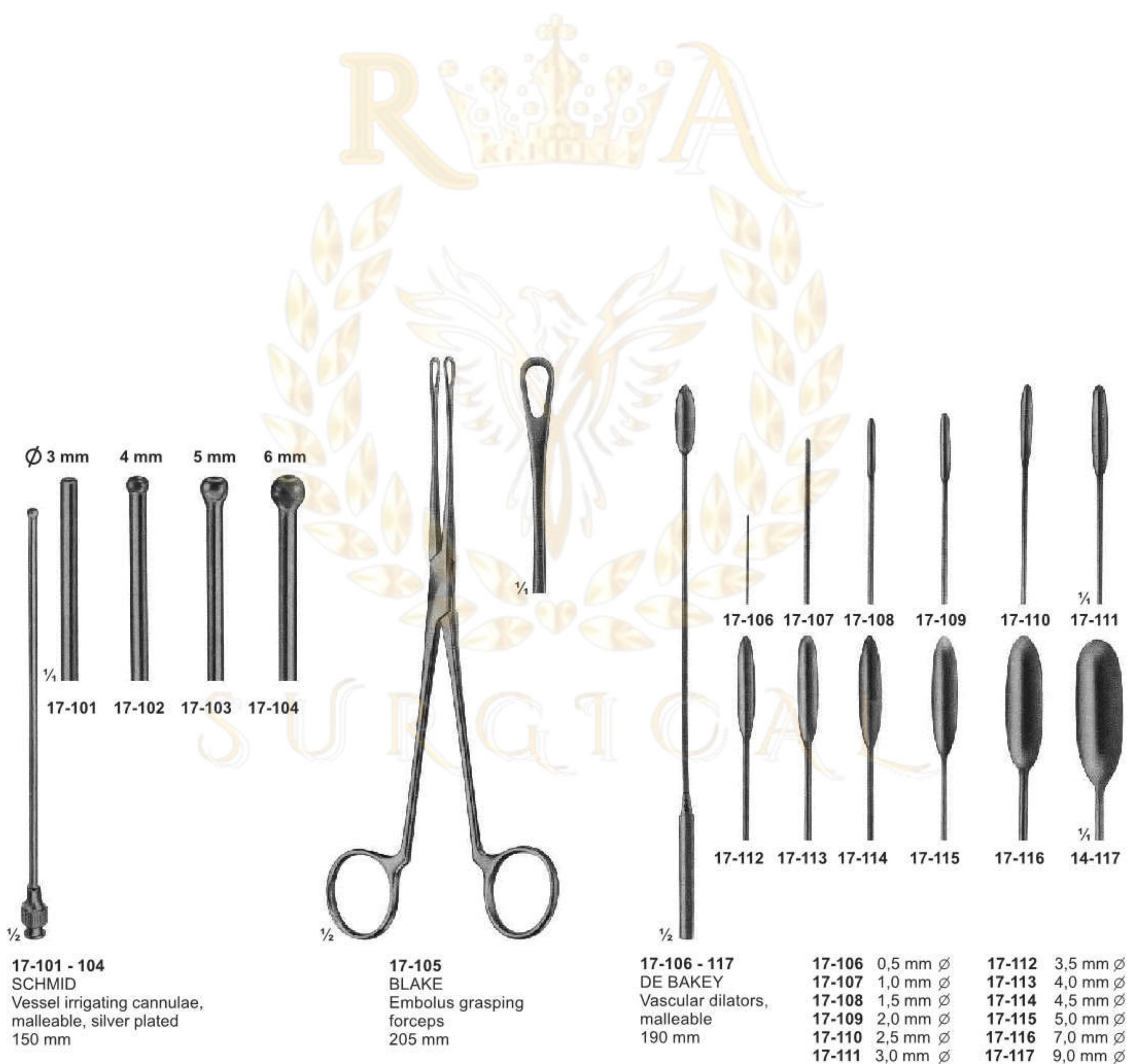

**17-101 - 104**  
SCHMID  
Vessel irrigating cannulae,  
malleable, silver plated  
150 mm

**17-105**  
BLAKE  
Embolus grasping  
forceps  
205 mm

**17-106 - 117**  
DE BAKEY  
Vascular dilators,  
malleable  
190 mm

<b>17-106</b>	0,5 mm Ø	<b>17-112</b>	3,5 mm Ø
<b>17-107</b>	1,0 mm Ø	<b>17-113</b>	4,0 mm Ø
<b>17-108</b>	1,5 mm Ø	<b>17-114</b>	4,5 mm Ø
<b>17-109</b>	2,0 mm Ø	<b>17-115</b>	5,0 mm Ø
<b>17-110</b>	2,5 mm Ø	<b>17-116</b>	7,0 mm Ø
<b>17-111</b>	3,0 mm Ø	<b>17-117</b>	9,0 mm Ø



# Irrigating Cannulae, Embolus Grasping Forceps, Dilators



# Irrigating Cannulae, Embolus Grasping Forceps, Dilators

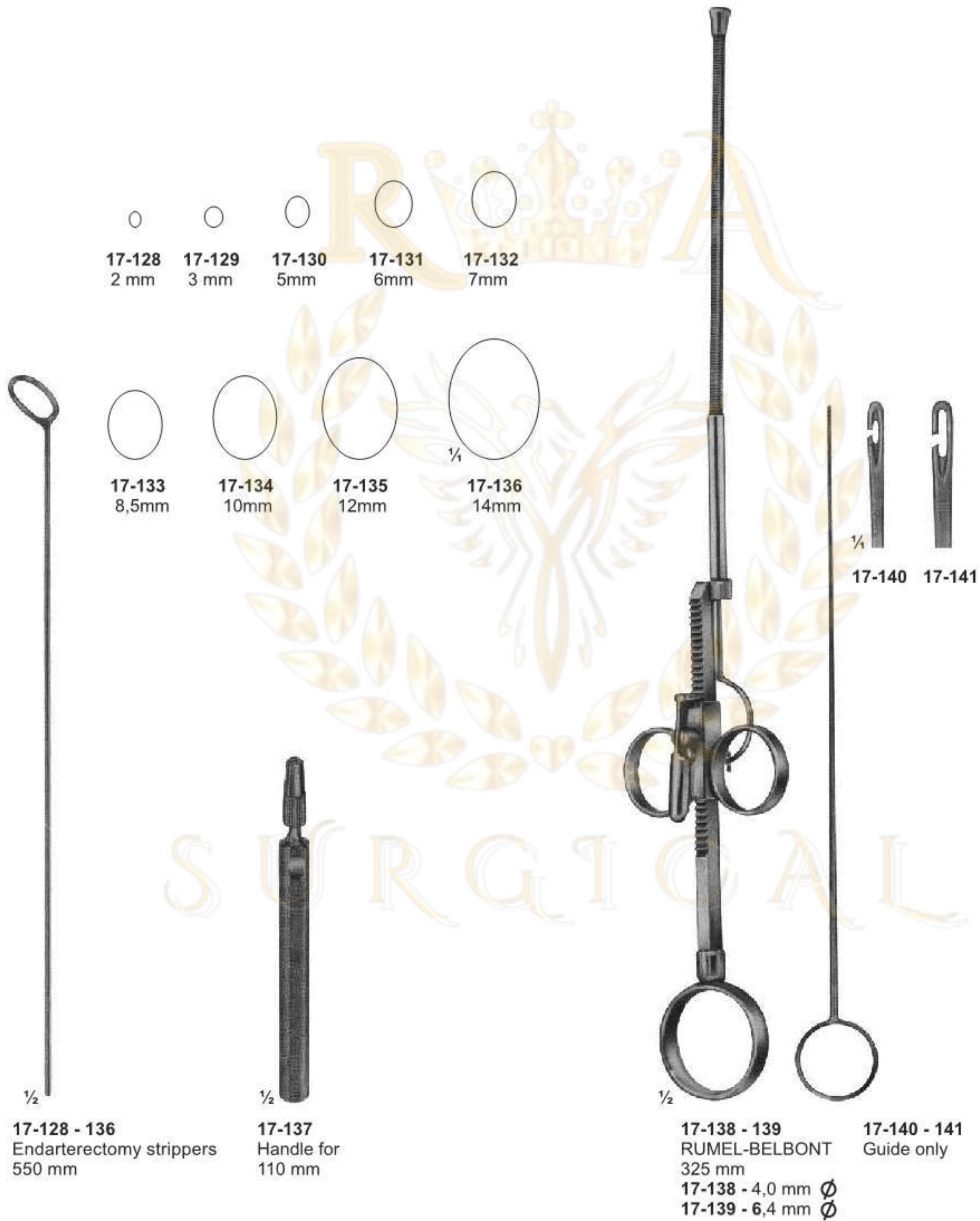

# Biopotome and Aortic Dilators

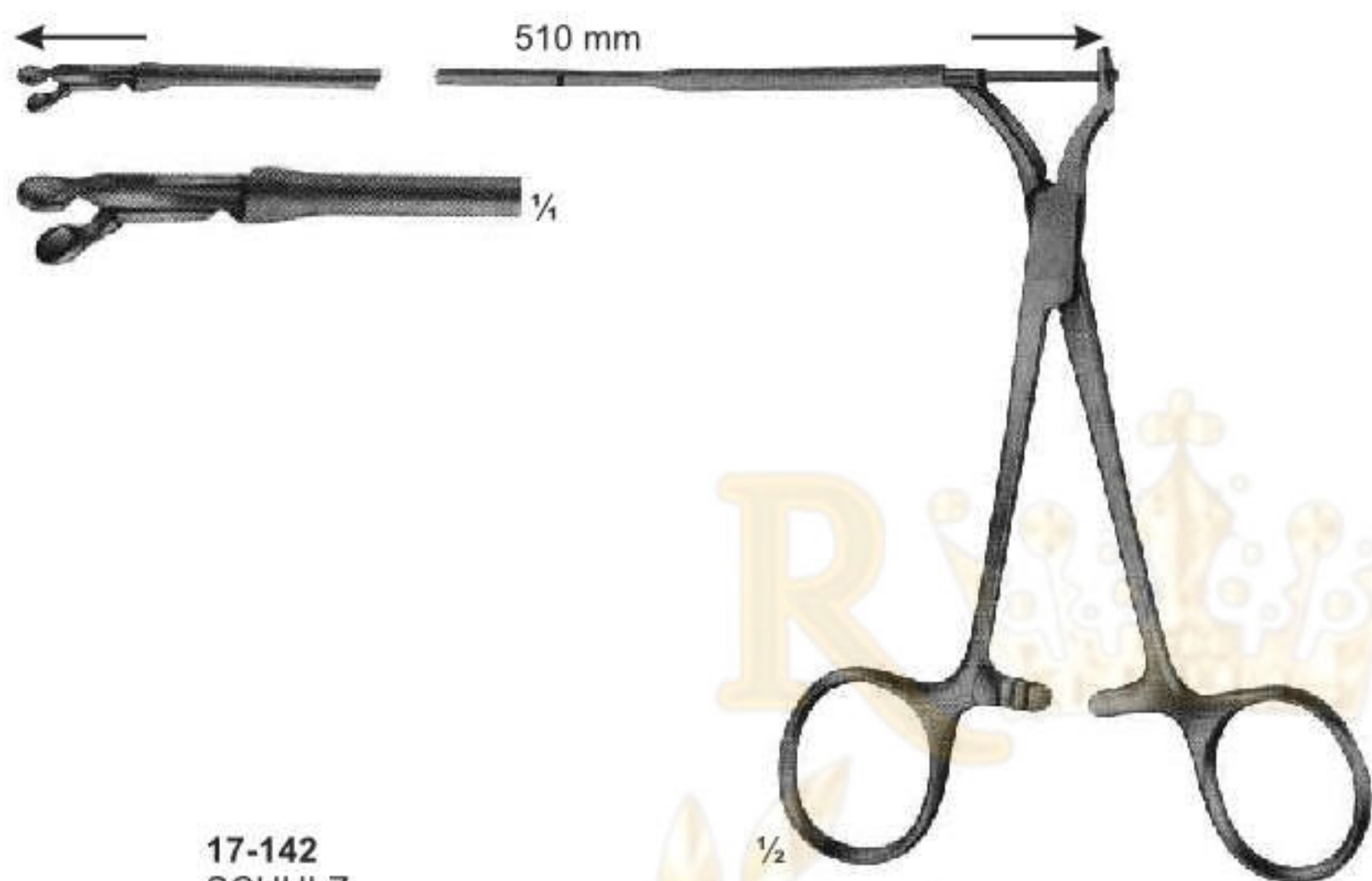

**17-142  
SCHULZ**  
Biopptome, mit flexiblem Schaft, 510 mm lang,  
with round jaws 3 mm diam.

Biopsy forceps, for biopsy from the right atrium  
through cava juglaris, prior to heart implantations.

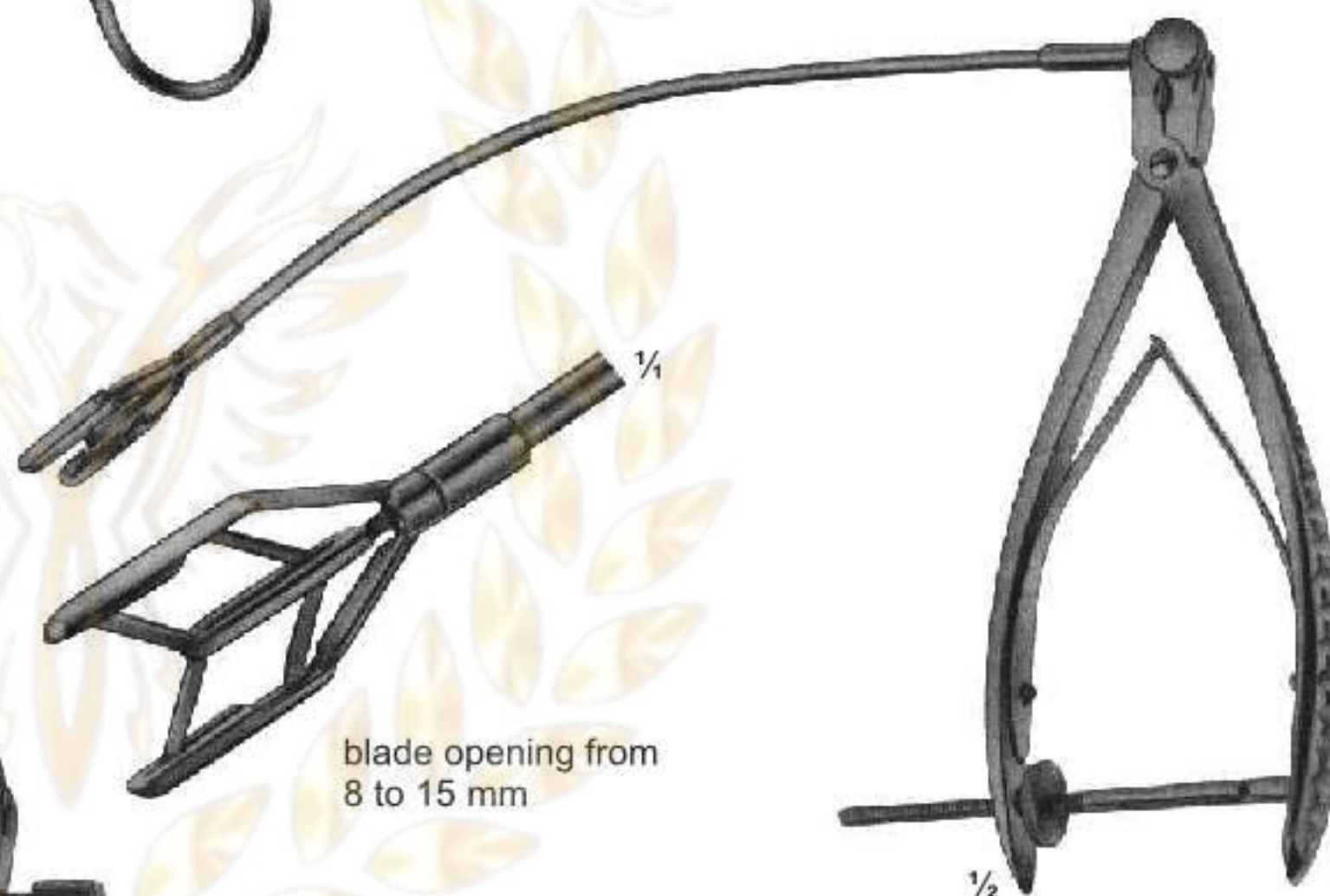

blade opening from  
8 to 15 mm

**17-144  
COOLEY**  
Dilator for  
mitral valve  
for children

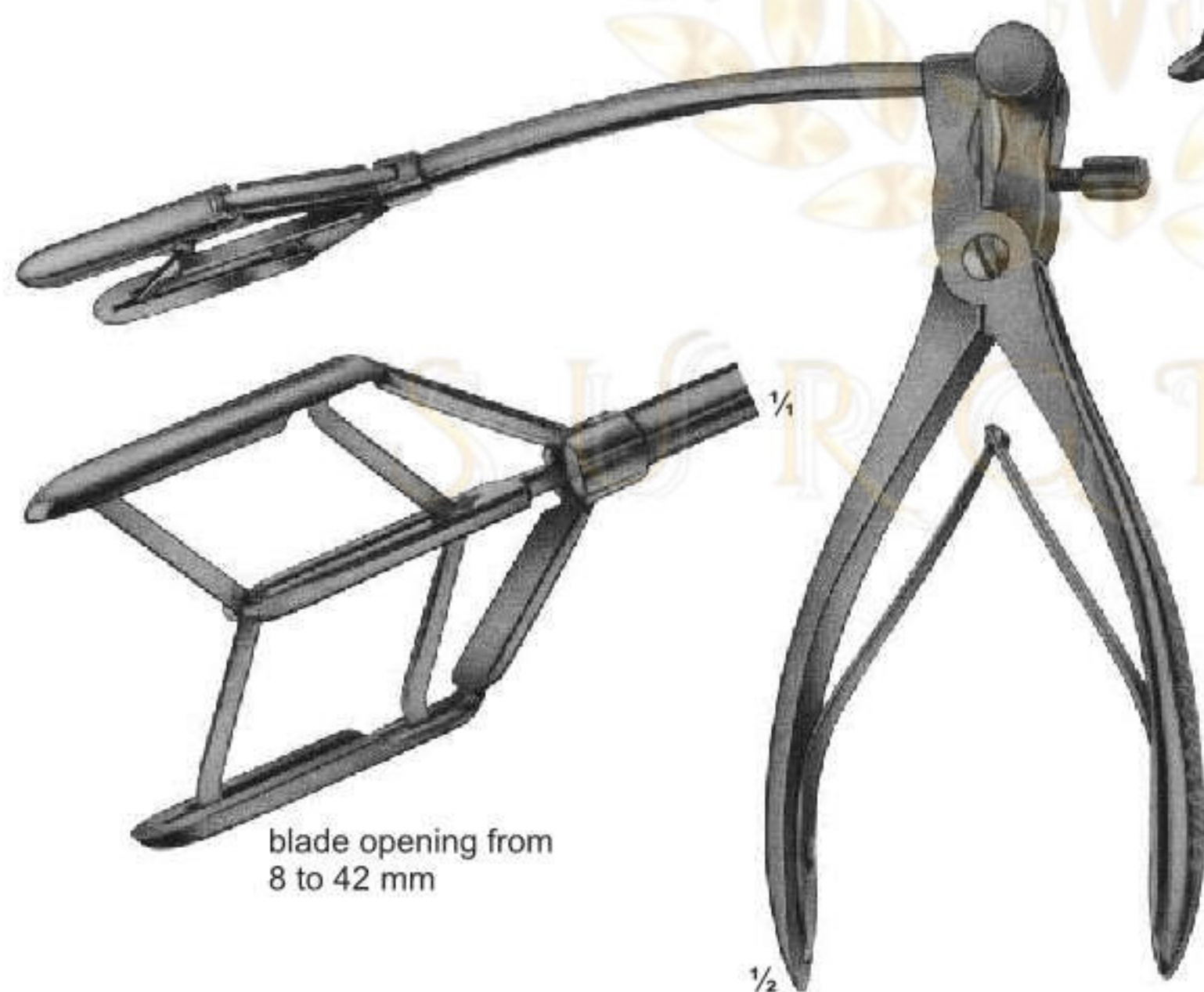

blade opening from  
8 to 42 mm

**17-143  
TUBBS**  
Dilator for  
mitral valve

# Biopotome and Aortic Dilators

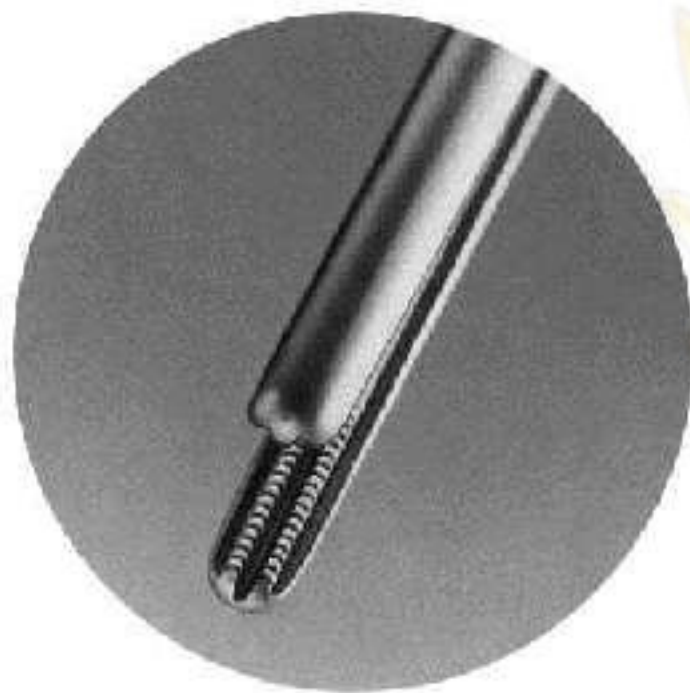
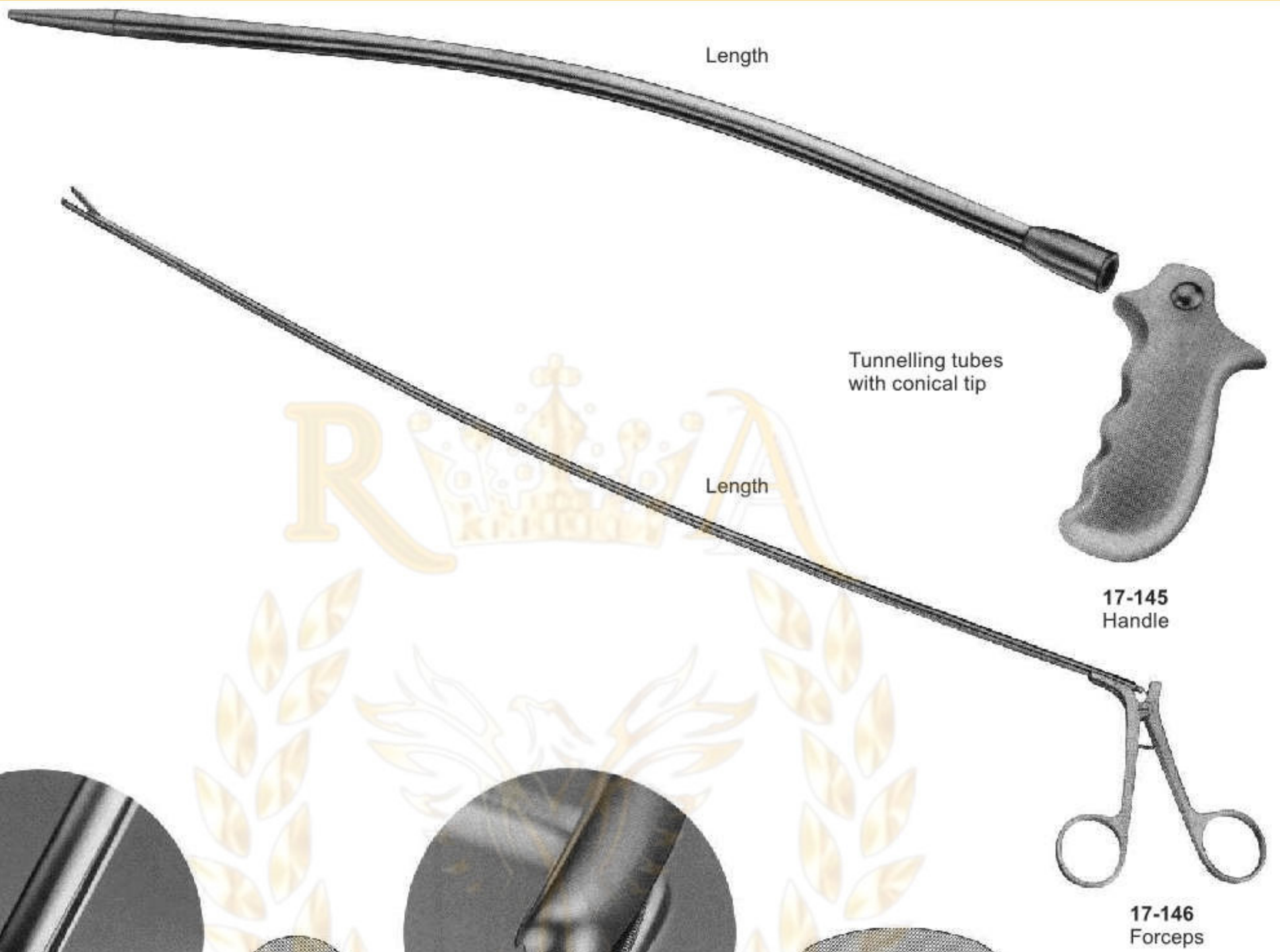

**DE BAKEY**  
17-147  
1 : 2 rows of teeth



**DE BAKEY**  
17-148  
2 : 3 rows of teeth

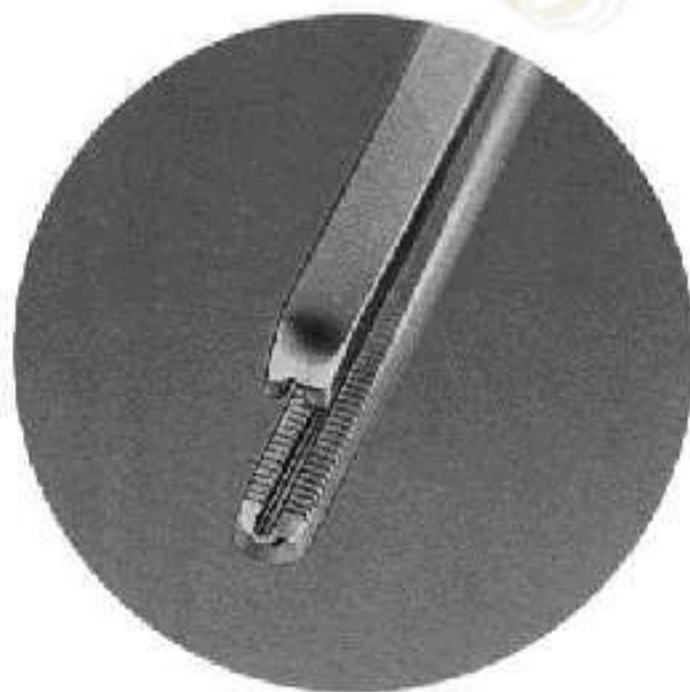
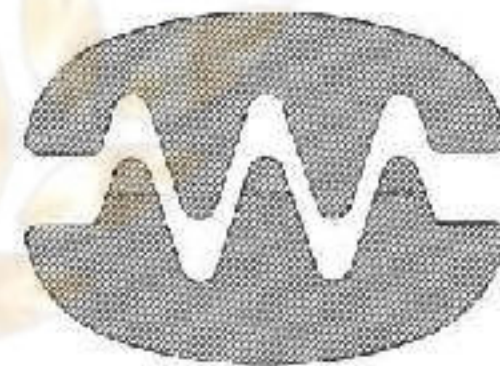

**COOLEY**  
17-149  
2 : 2 rows of teeth

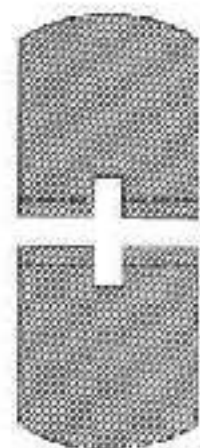

**DARDIK**  
17-150  
2 : 3 rows of teeth

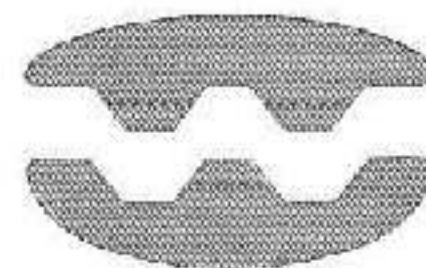

# Ultra-Light-Forceps

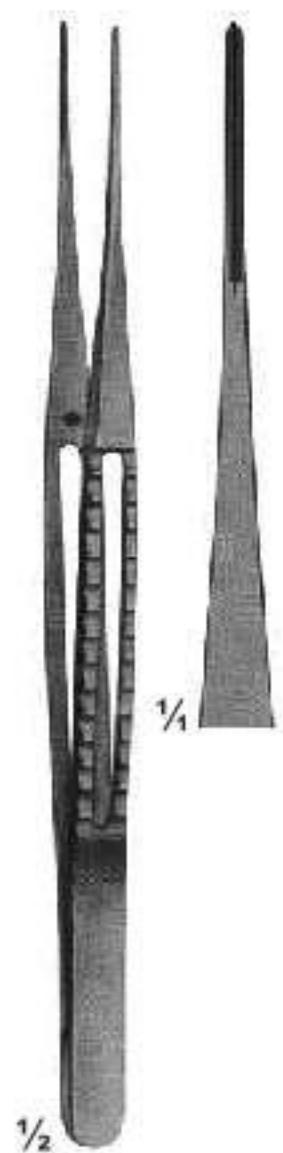

**17-151**  
Width of jaws  
1,5 mm  
Length  
150mm



$\frac{1}{2}$   
**17-152**  
1,5 mm  
200 mm



$\frac{1}{2}$   
**17-153**  
1,5 mm  
240 mm



$\frac{1}{2}$   
**17-154**  
1,5 mm  
300 mm

# Ultra-Light-Forceps



**17-155 - 156**  
DE BAKEY  
150 mm  
300 mm



**17-155**  
1,5 mm



**17-156**  
1,5 mm



**17-157 - 160**  
DE BAKEY  
150 mm 200 mm  
300 mm 240 mm



**17-157**  
2 mm



**17-158**  
2 mm



**17-159**  
2 mm



**17-160**  
2 mm



**17-161 - 164**  
DE BAKEY  
150 mm 200 mm  
300 mm 240 mm



**17-161**  
2,8 mm



**17-162**  
2,8 mm



**17-163**  
2,8 mm



**17-164**  
2,8 mm



**17-165 - 167**  
DE BAKEY  
200 mm  
300 mm 240 mm



**17-165**  
3,3mm



**17-166**  
3,5 mm

**17-167**  
3,3 mm



**17-168**  
DE BAKEY  
150 mm



**17-168**  
2 mm



**17-169**  
DE BAKEY  
200 mm



**17-169**  
2 mm

# Ring Handle Bulldog Clamps

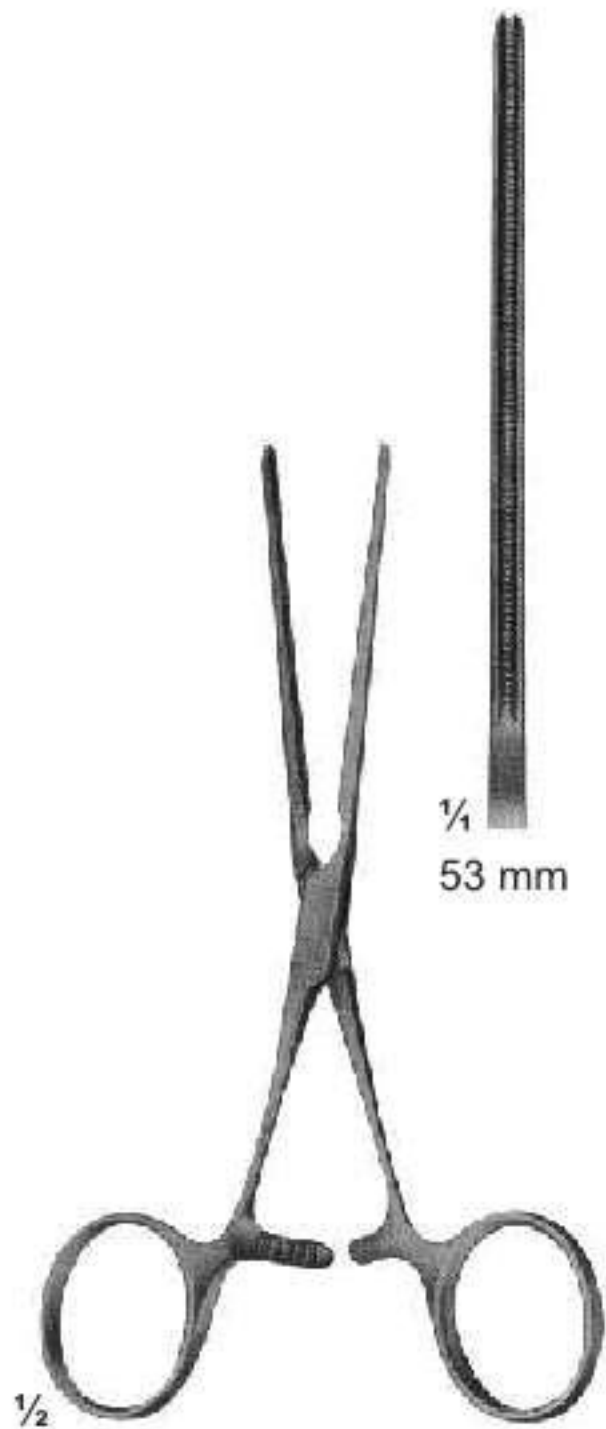

**17-170**  
DE-BAKEY  
gerade straight  
130 mm



**17-171**  
DE-BAKEY  
Maul gebogen  
curved jaws  
125 mm

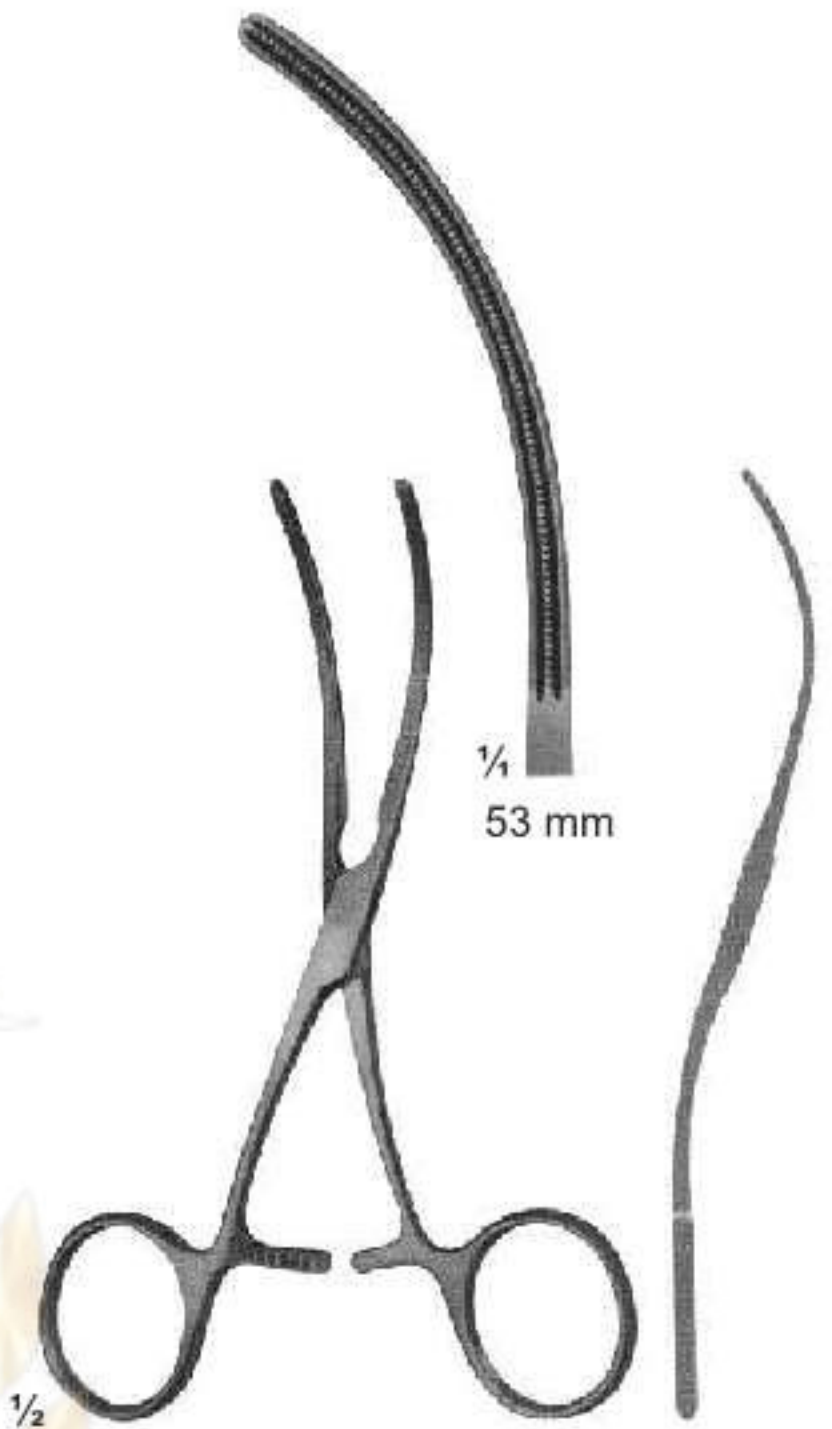

**17-172**  
DE-BAKEY  
S-shaped curved  
125 mm

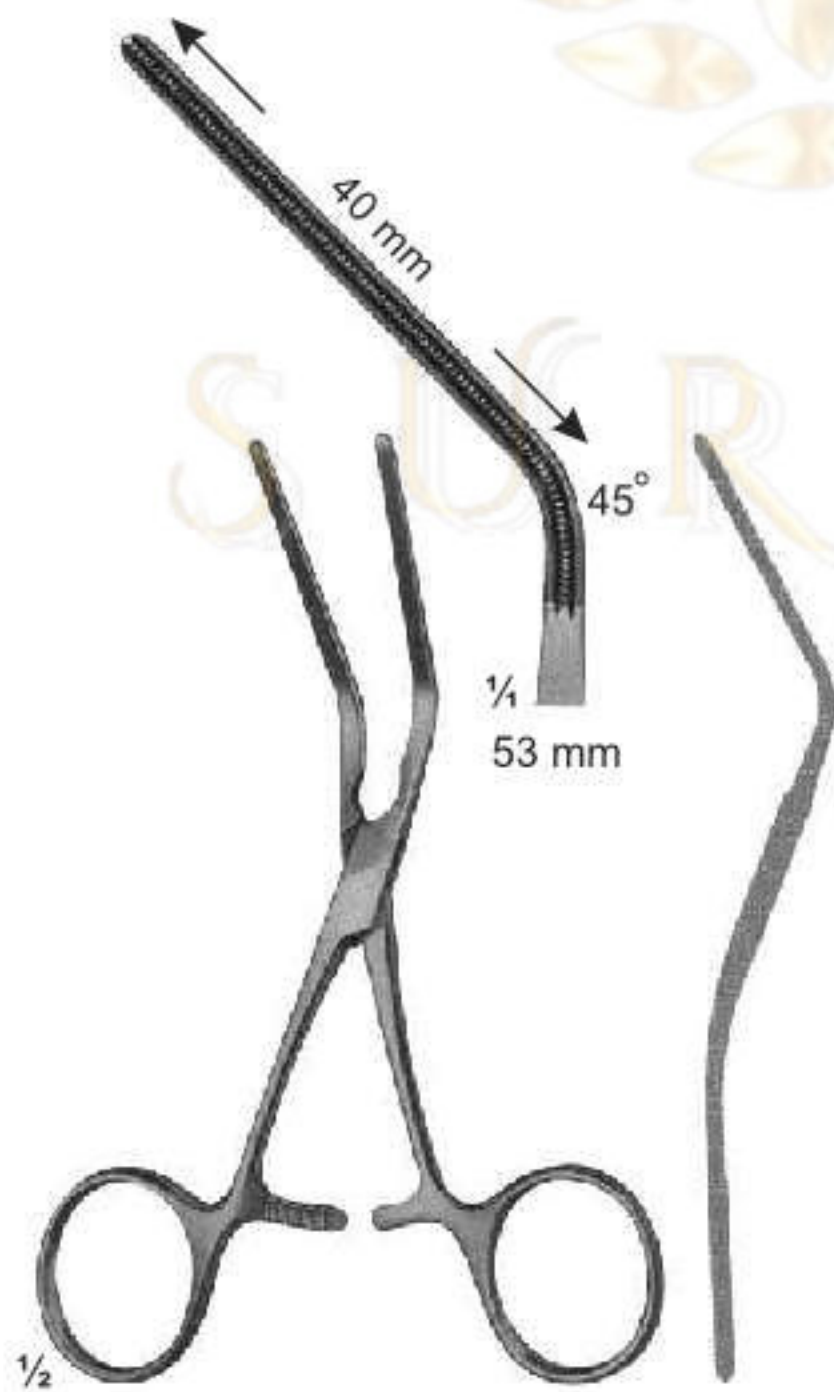

**17-173**  
DE-BAKEY  
45° winklig gebogen  
angled 45°  
125 mm

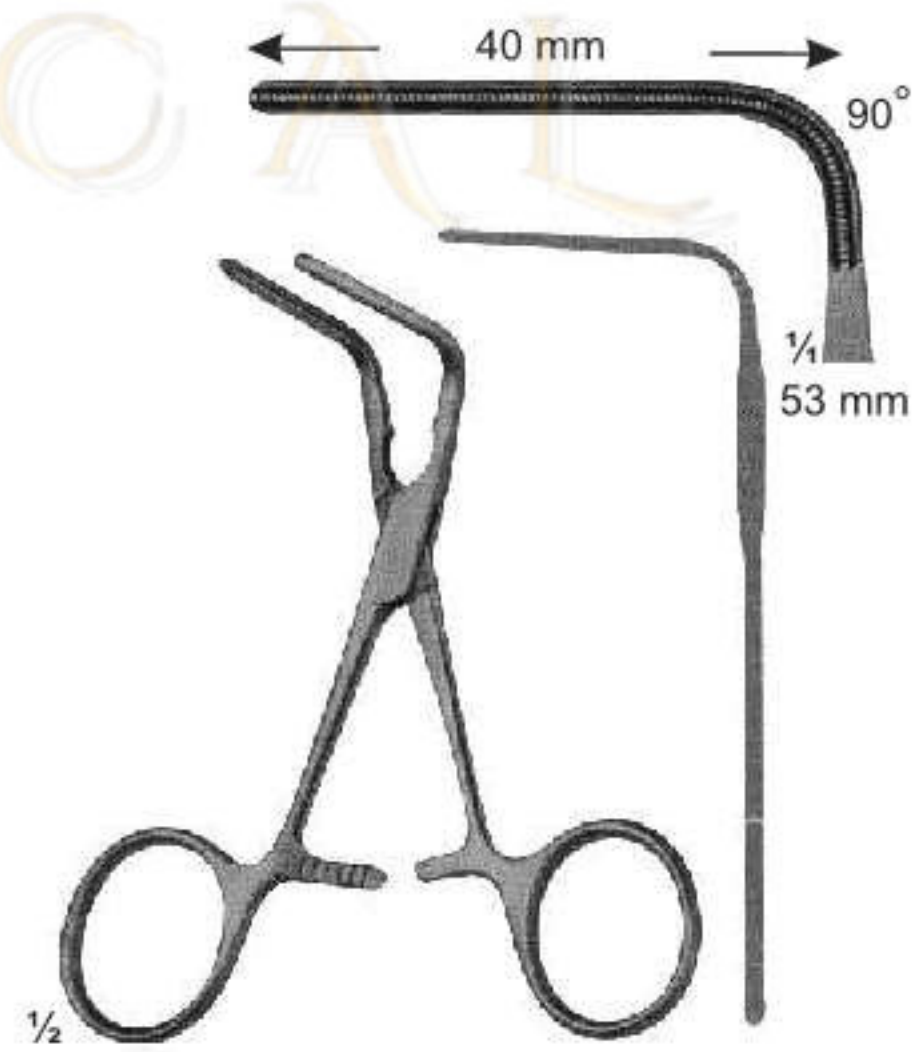

**17-174**  
DE-BAKEY  
90° winklig gebogen  
angled 90°  
105 mm

# Anastomosis-and Multi-Purpose-Clamps for Neonatales

graduated



**17-175 - 178**  
CASTANESA

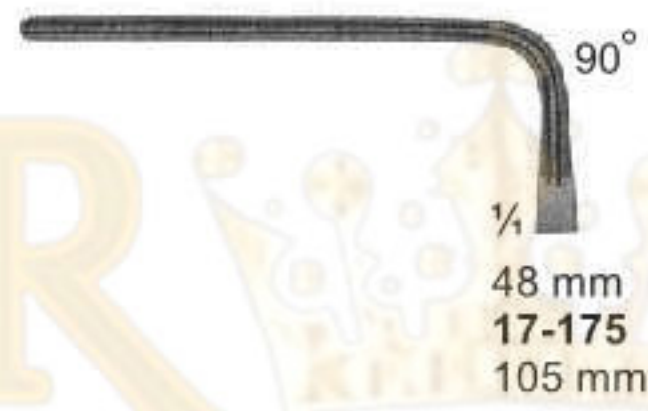

graduated



**17-179 - 182**  
CASTANESA

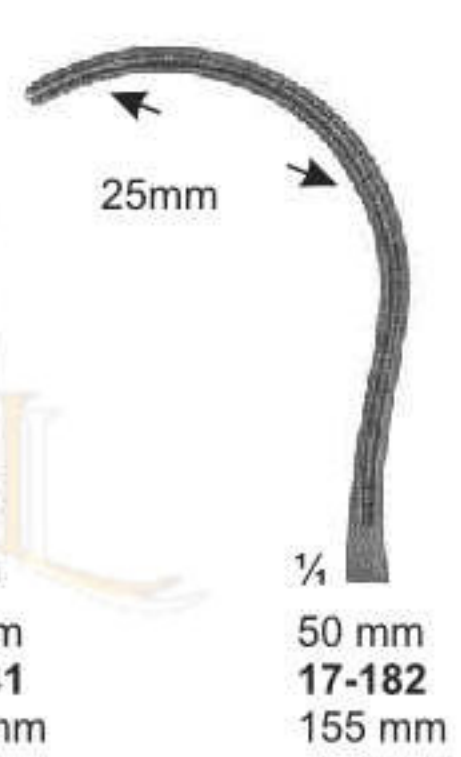
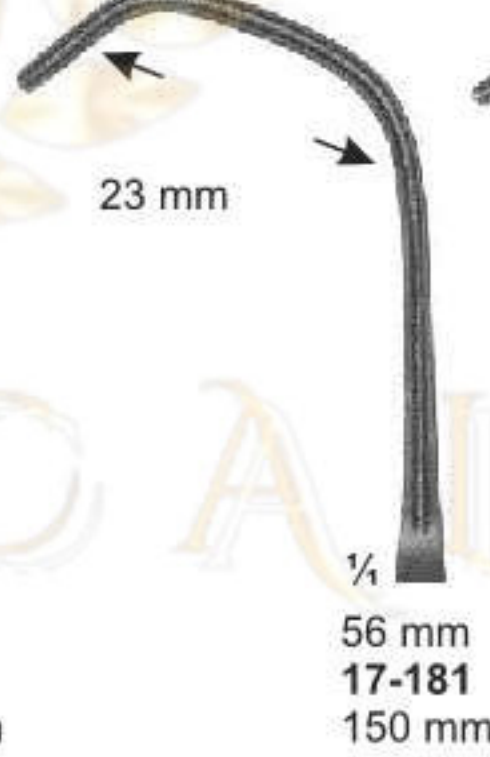
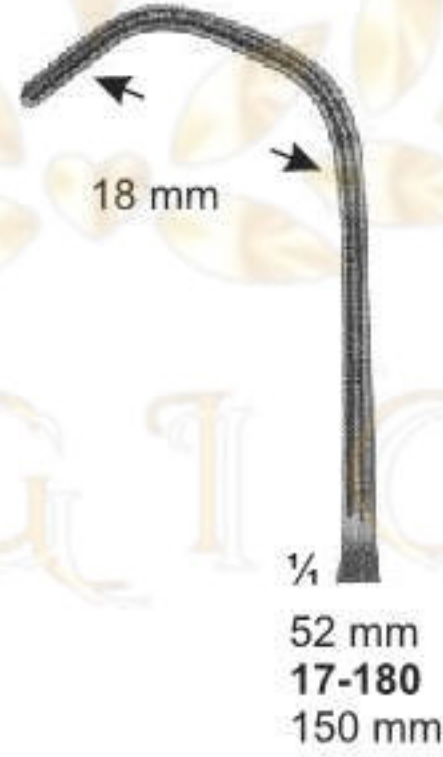



# Anastomosis-and Multi-Purpose-Clamps-Pediatric types

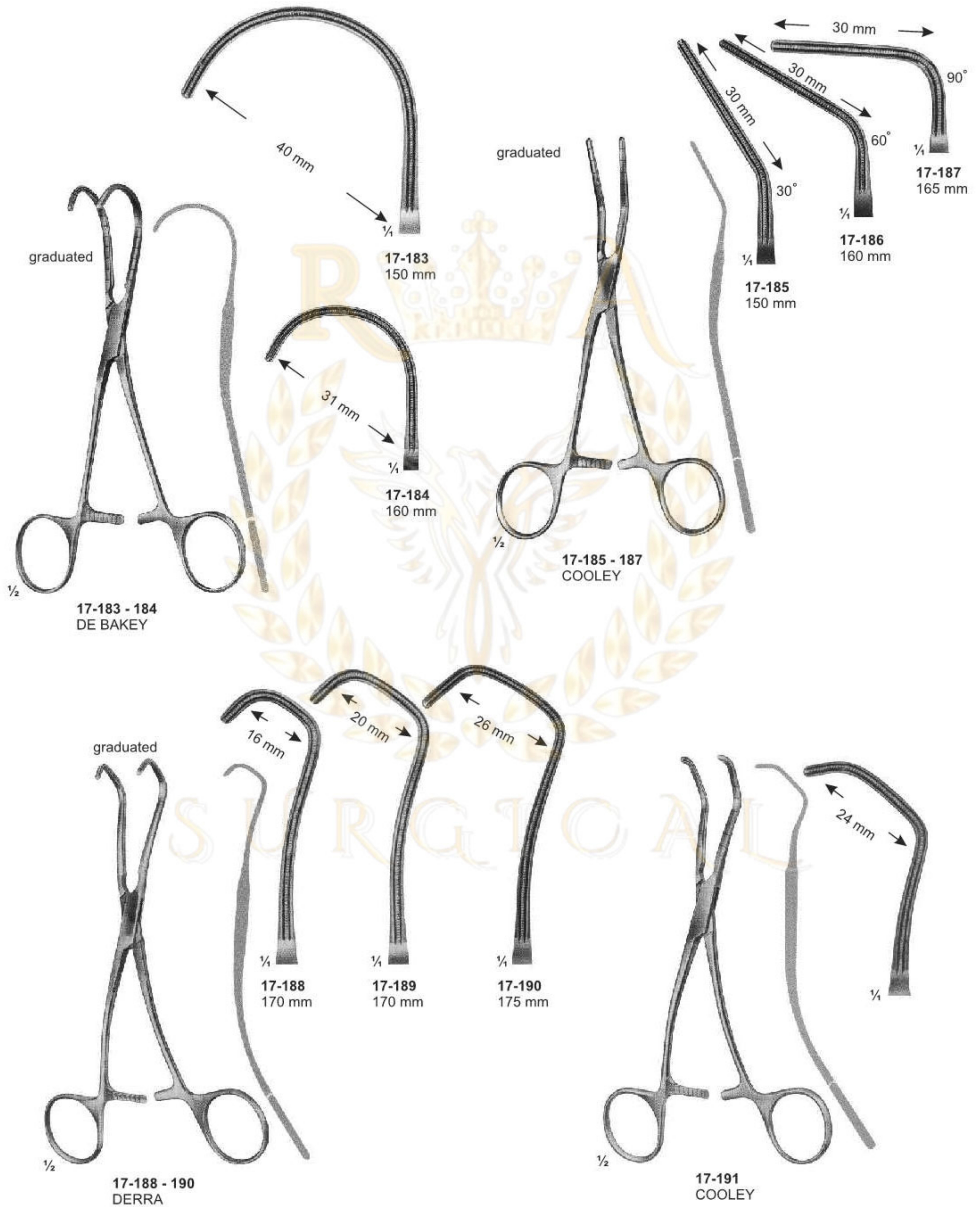

# Non-traumatic Haemostatic Forceps

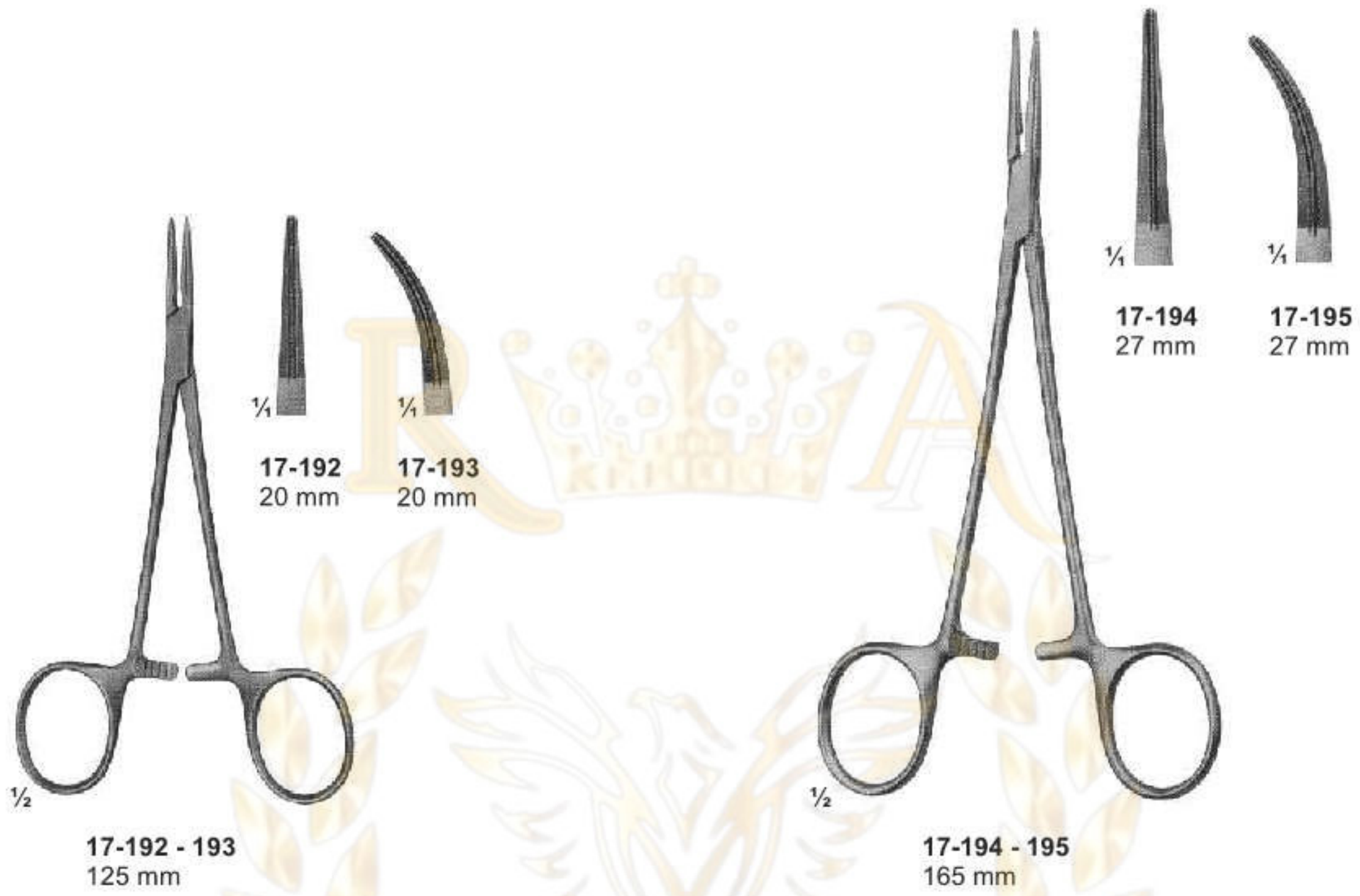

# Non-traumatic Haemostatic Forceps

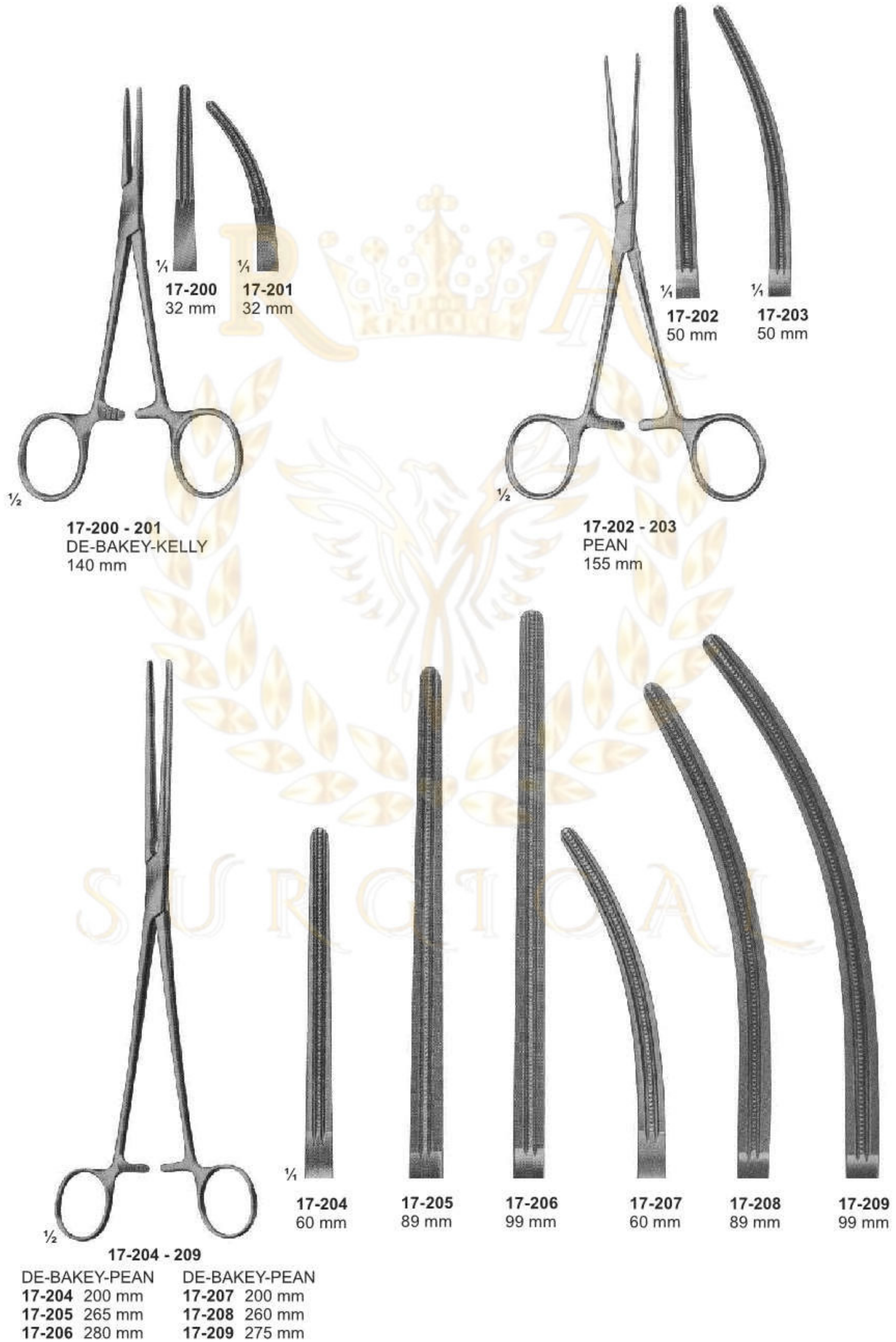

# Anastomosis Clamps

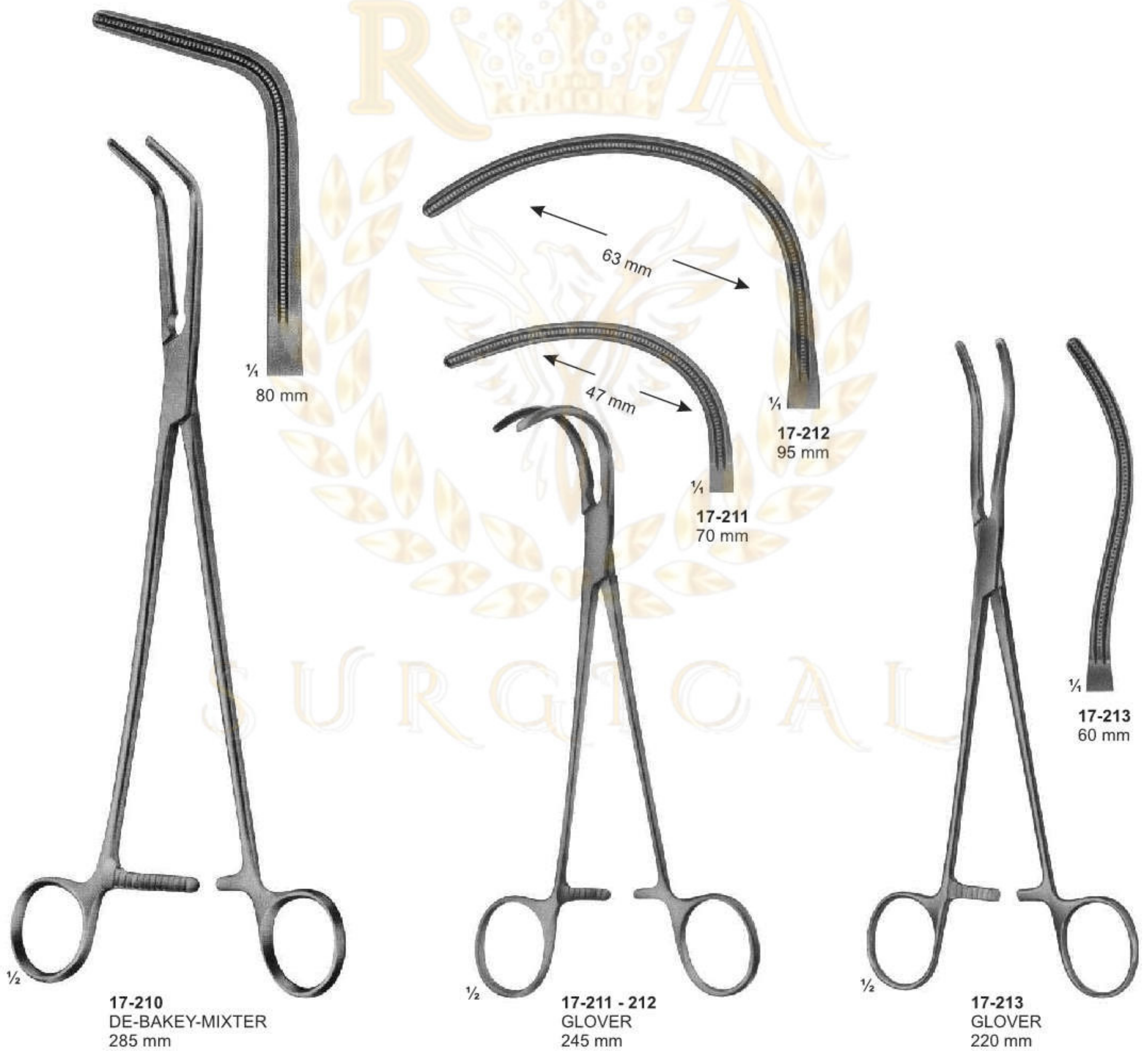

# Vena-Cava Clamps

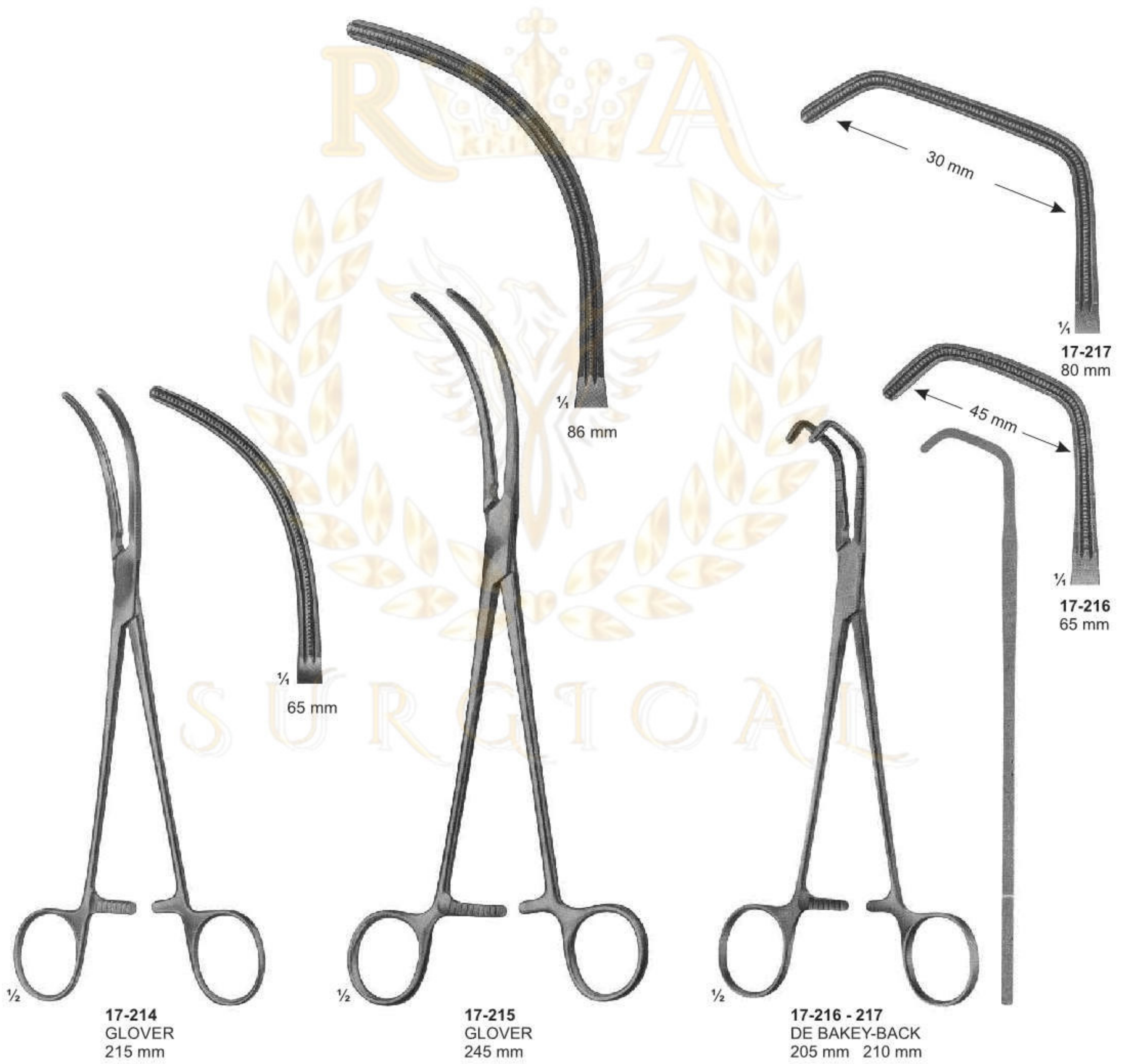

# Vena-Cava Clamps



1/2



1/4  
17-218  
86 mm

1/4  
17-219  
86 mm

1/4  
17-220  
86 mm

1/4  
17-221  
86 mm

17-218 - 221  
DE BAKEY-HARKEN  
17-218 - 255 mm  
17-219 - 245 mm  
17-220 - 245 mm  
17-221 - 245 mm



1/2

17-222 - 226  
DE BAKEY

Total Length:

Length of jaws:



1/4  
17-222

1/4  
17-223

1/4  
17-224

1/4  
17-225

1/4  
17-226

220 mm

256 mm

270 mm

270 mm

280 mm

85 mm

95 mm

99 mm

103 mm

119 mm

# Vena-Cava Clamps

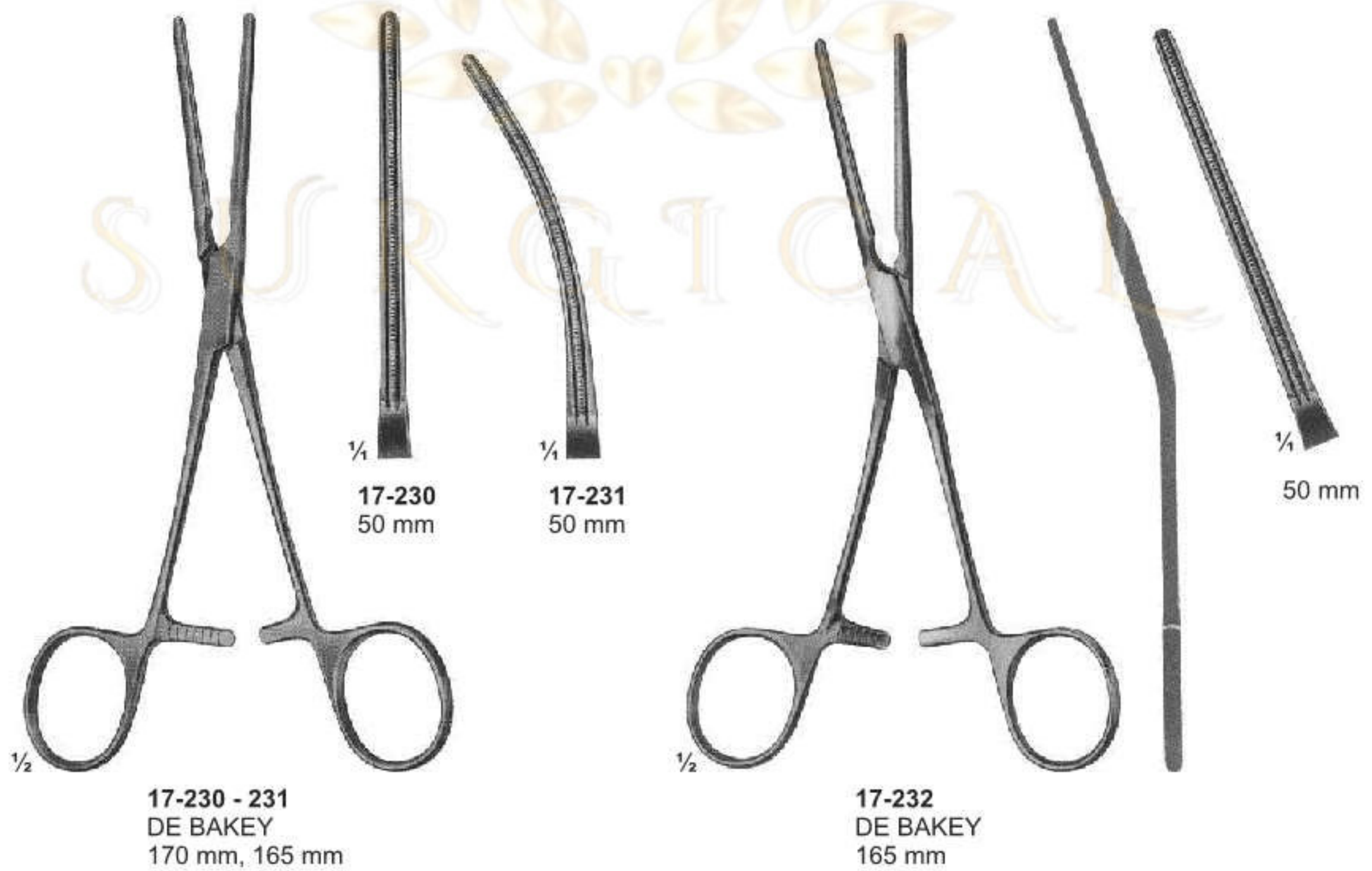

# Vena-Cava Clamps



**17-233 - 235**  
DE BAKEY  
205 mm, 225 mm, 240 mm



**17-233** 41 mm  
**17-234** 65 mm  
**17-235** 80 mm



**17-236 - 238**  
DE BAKEY  
200 mm, 225 mm, 240 mm



**17-236** 41 mm  
**17-237** 65 mm  
**17-238** 80 mm



**17-239**  
DE BAKEY  
210 mm



**1/4**  
51 mm



**17-240**  
DE BAKEY  
210 mm



15°  
**1/4**  
51 mm



**17-241**  
DE BAKEY  
160 mm



**1/4**  
56 mm



# Vena-Cava Clamps

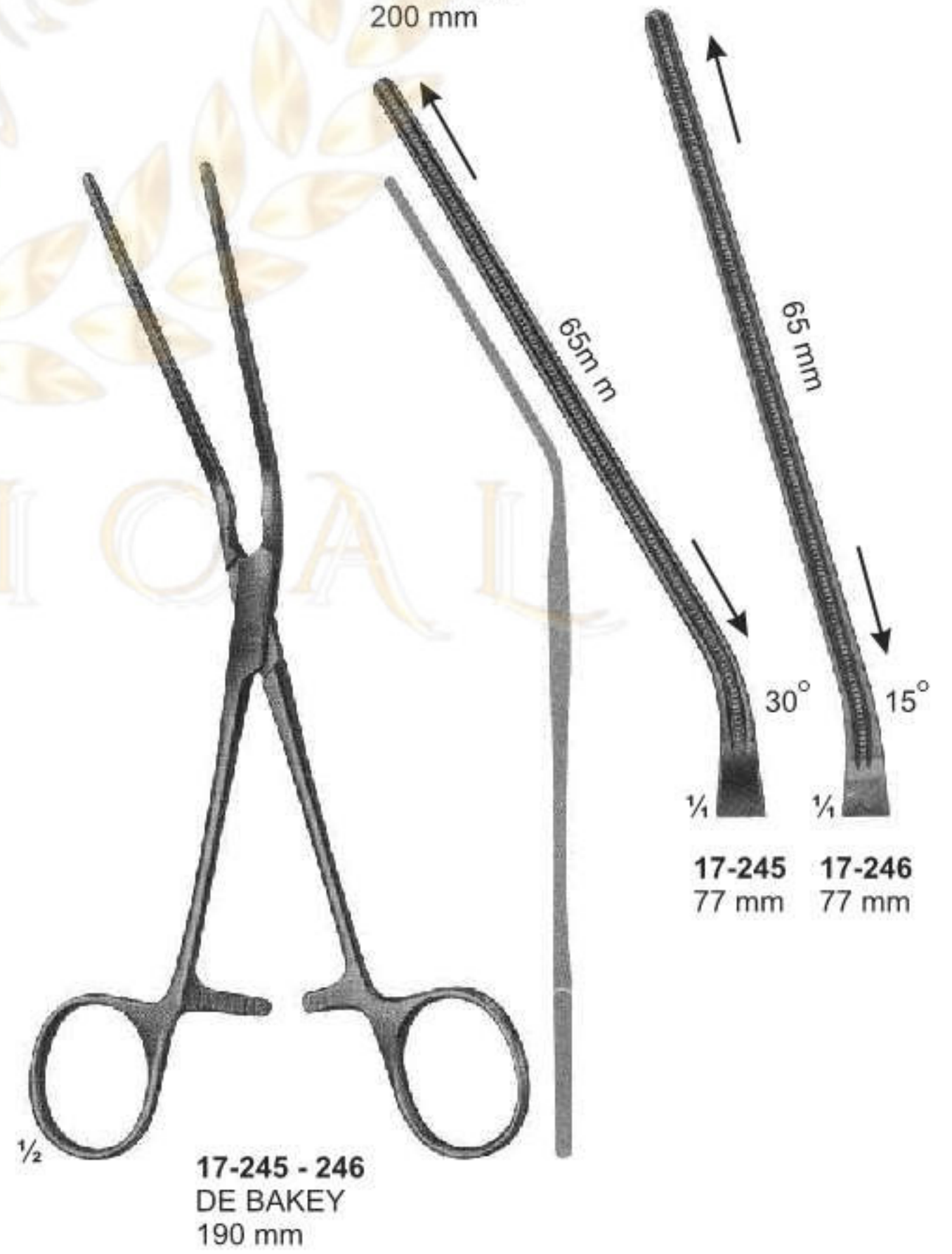
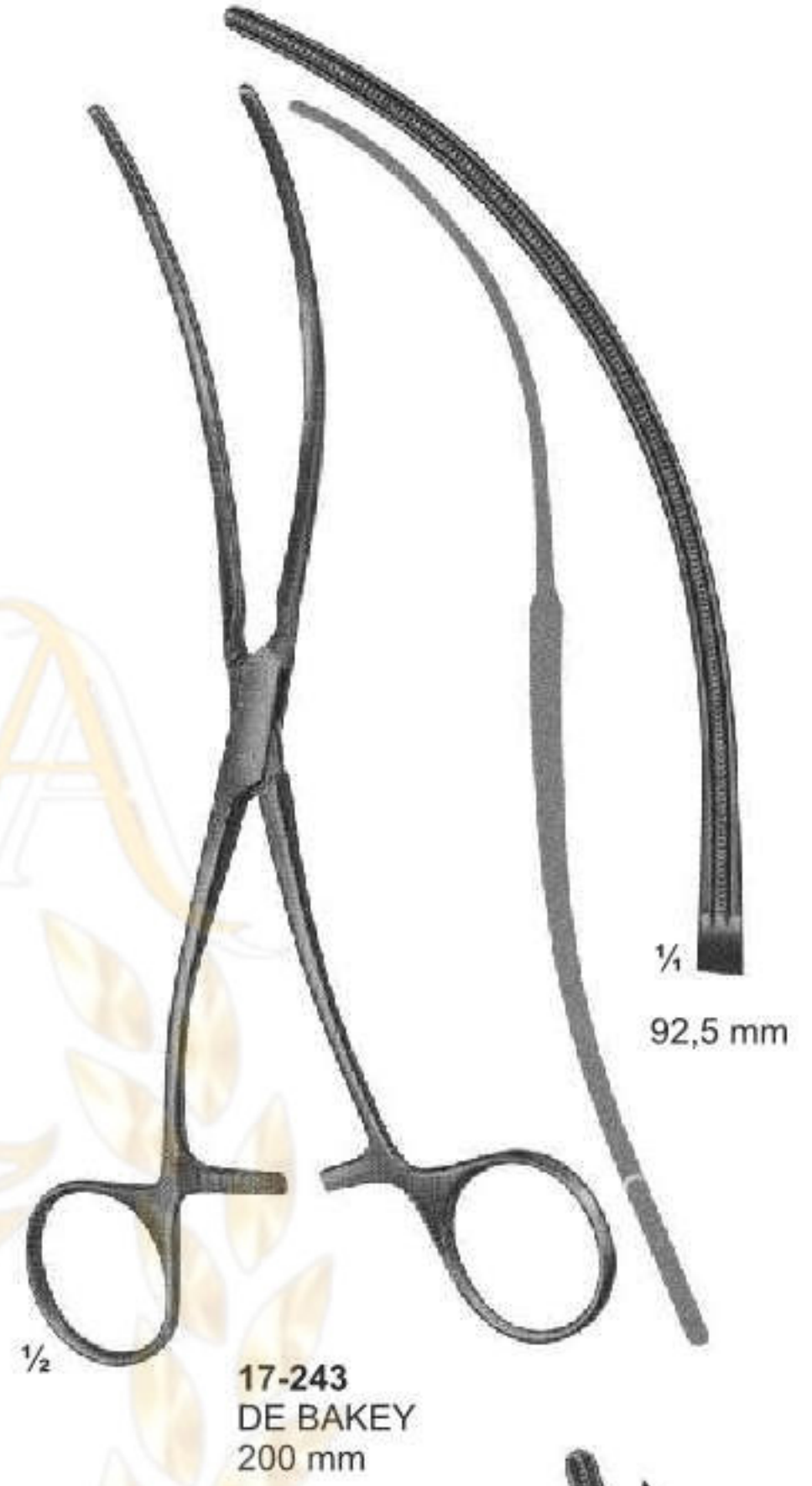

# Vena-Cava Clamps



**17-247**  
LELAND-JONES  
195 mm



**17-248**  
DE BAKEY  
200 mm



**17-249**  
WERTHEIM  
250 mm

Iliac clamp

# Vena-Cava Clamps

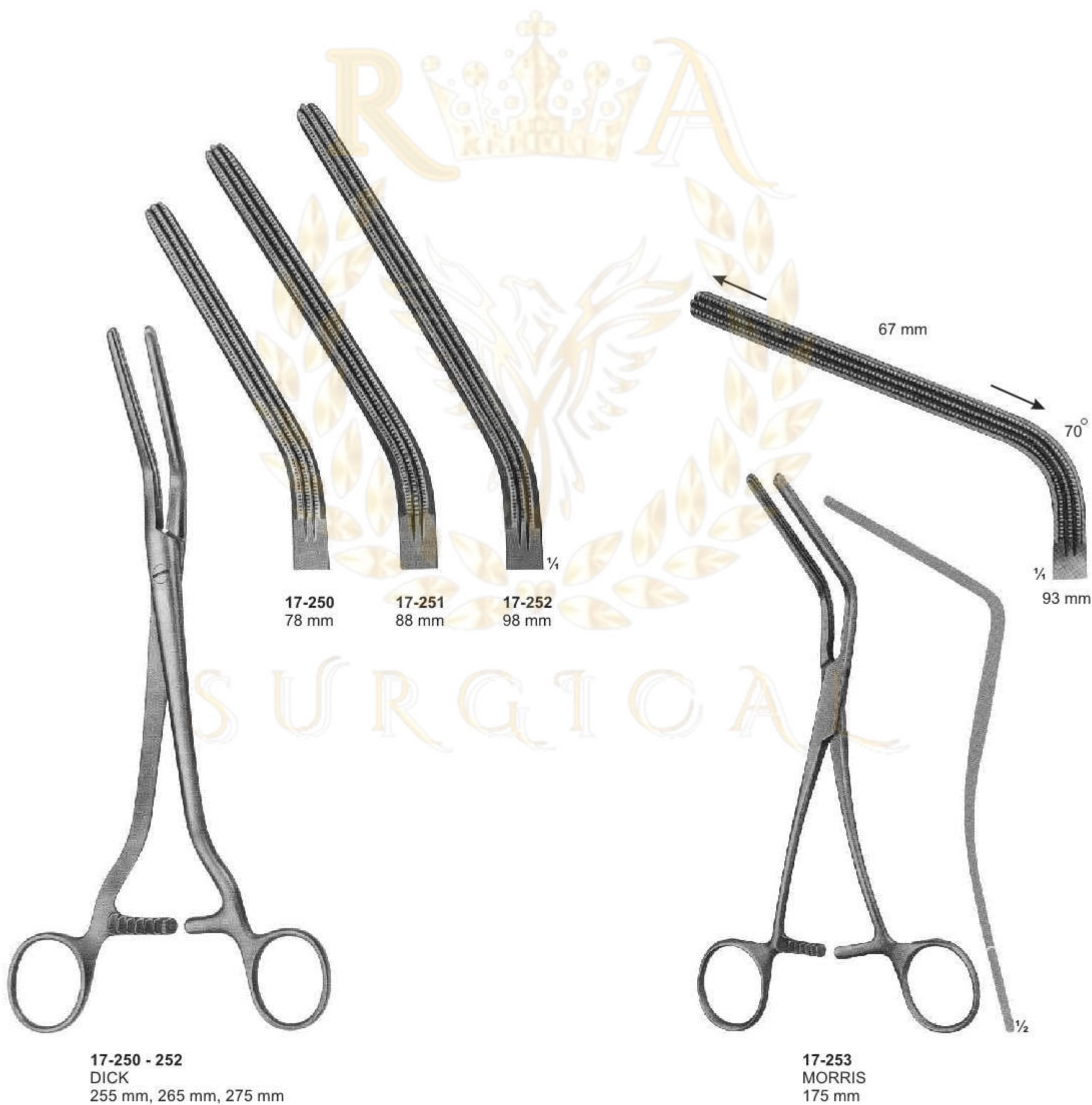

# Vena-Cava Clamps

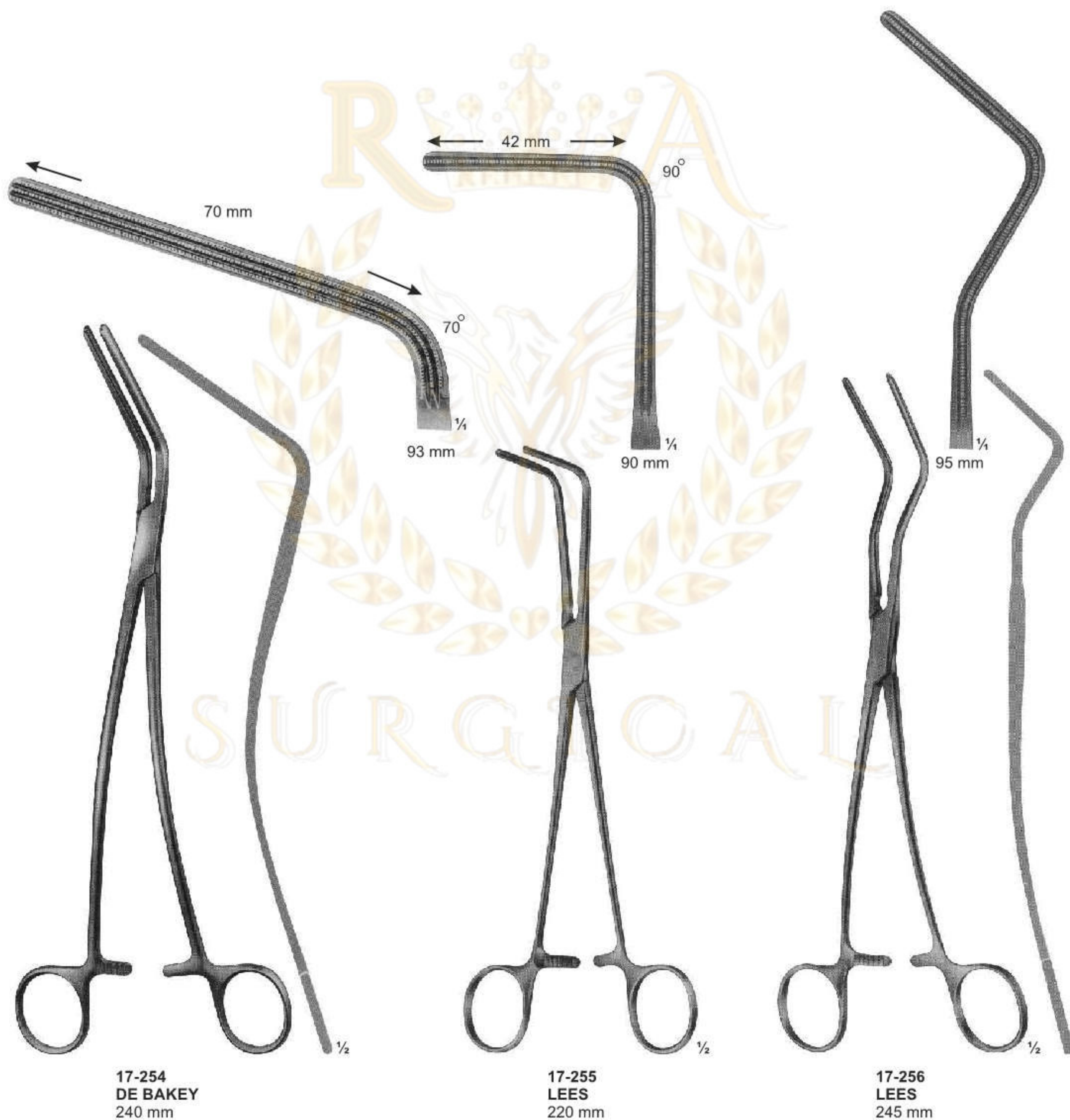

# Vena-Cava Clamps



**17-257  
DE BAKEY**  
265 mm

**17-258  
DE BAKEY**  
270 mm

**17-259 - 261  
DE BAKEY**  
255 mm, 265 mm, 280 mm

# Vena-Cava Clamps



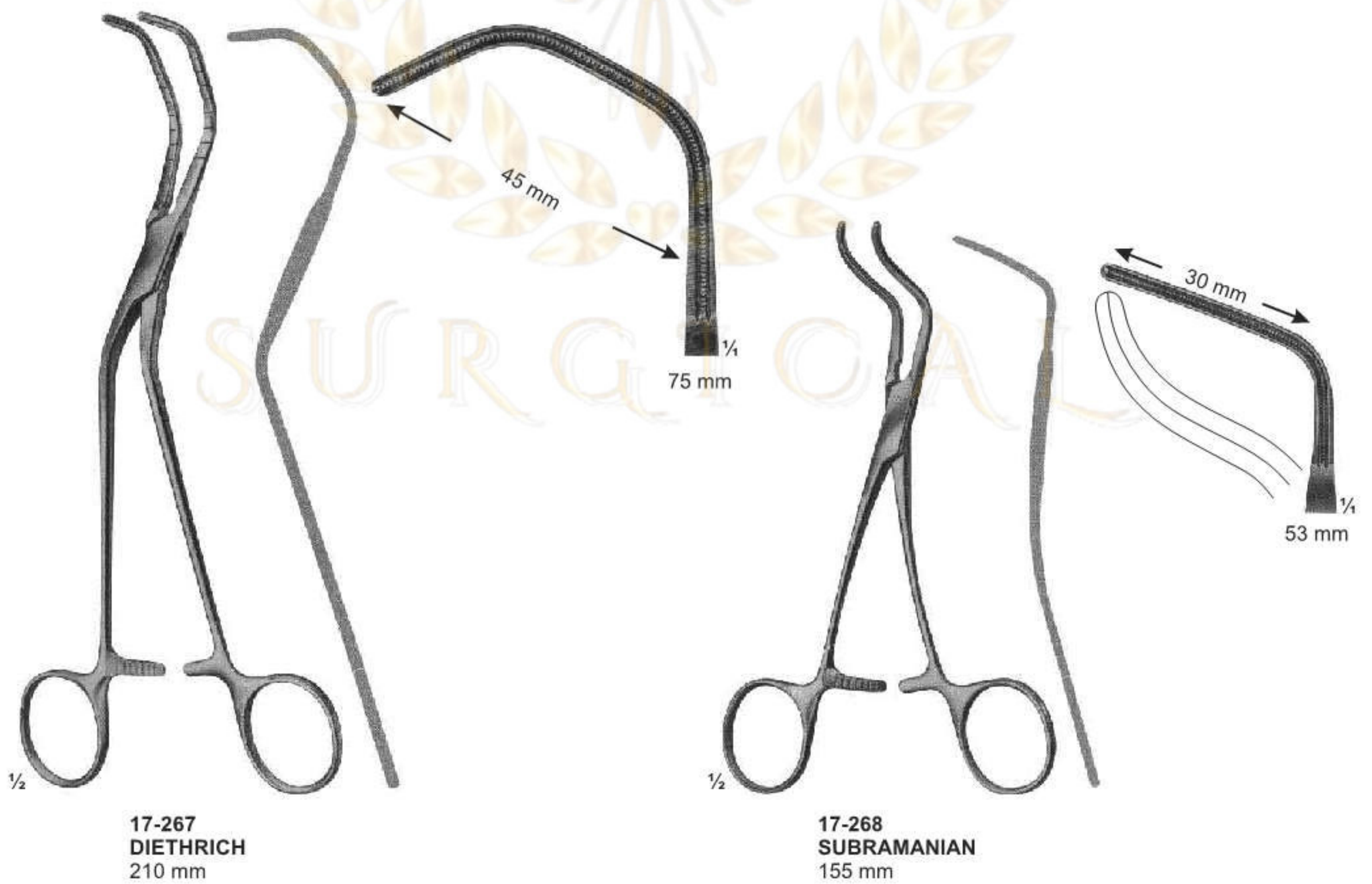

# Vena-Cava Clamps

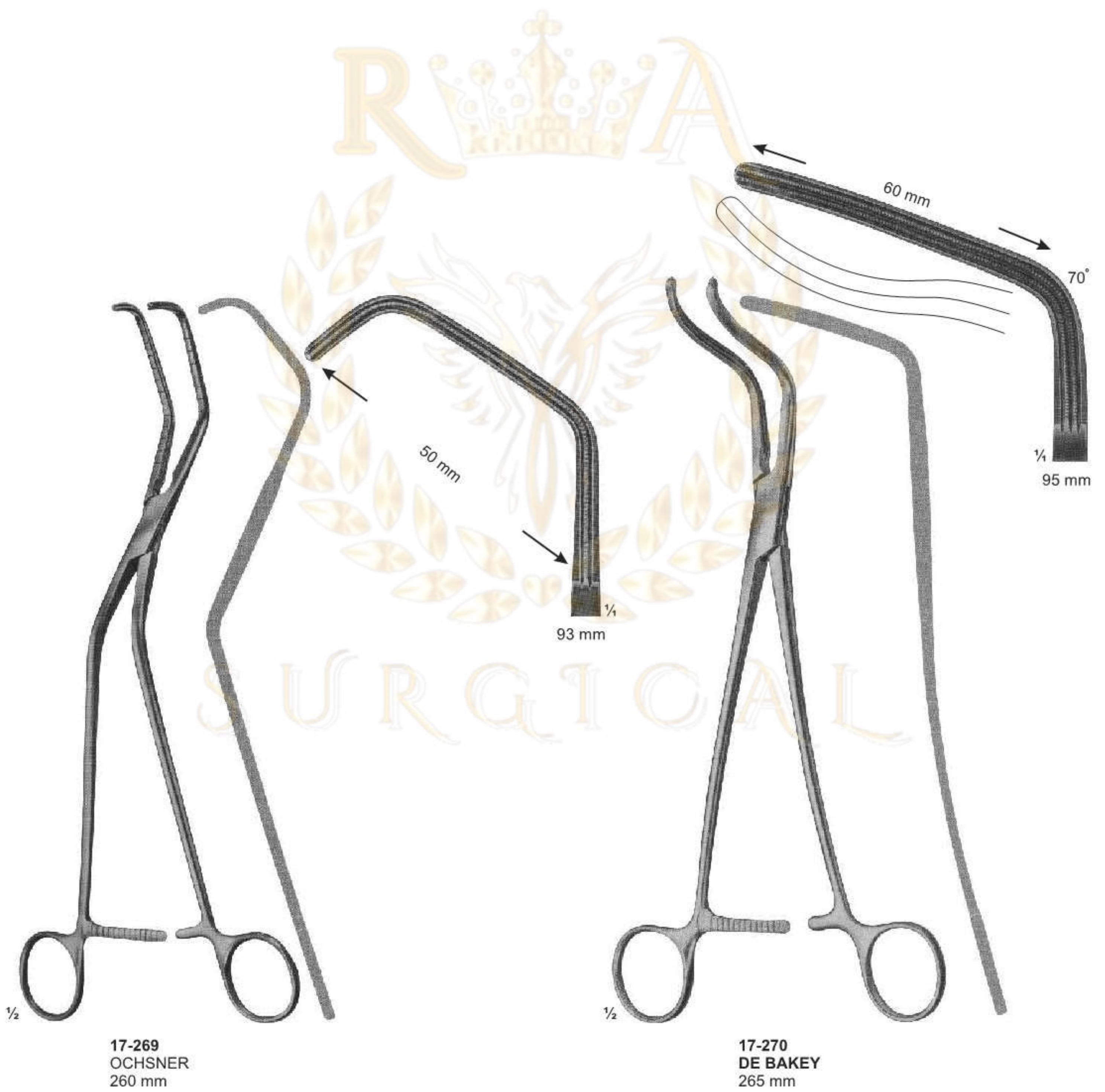



# Aorta-Anastomosis Clamps

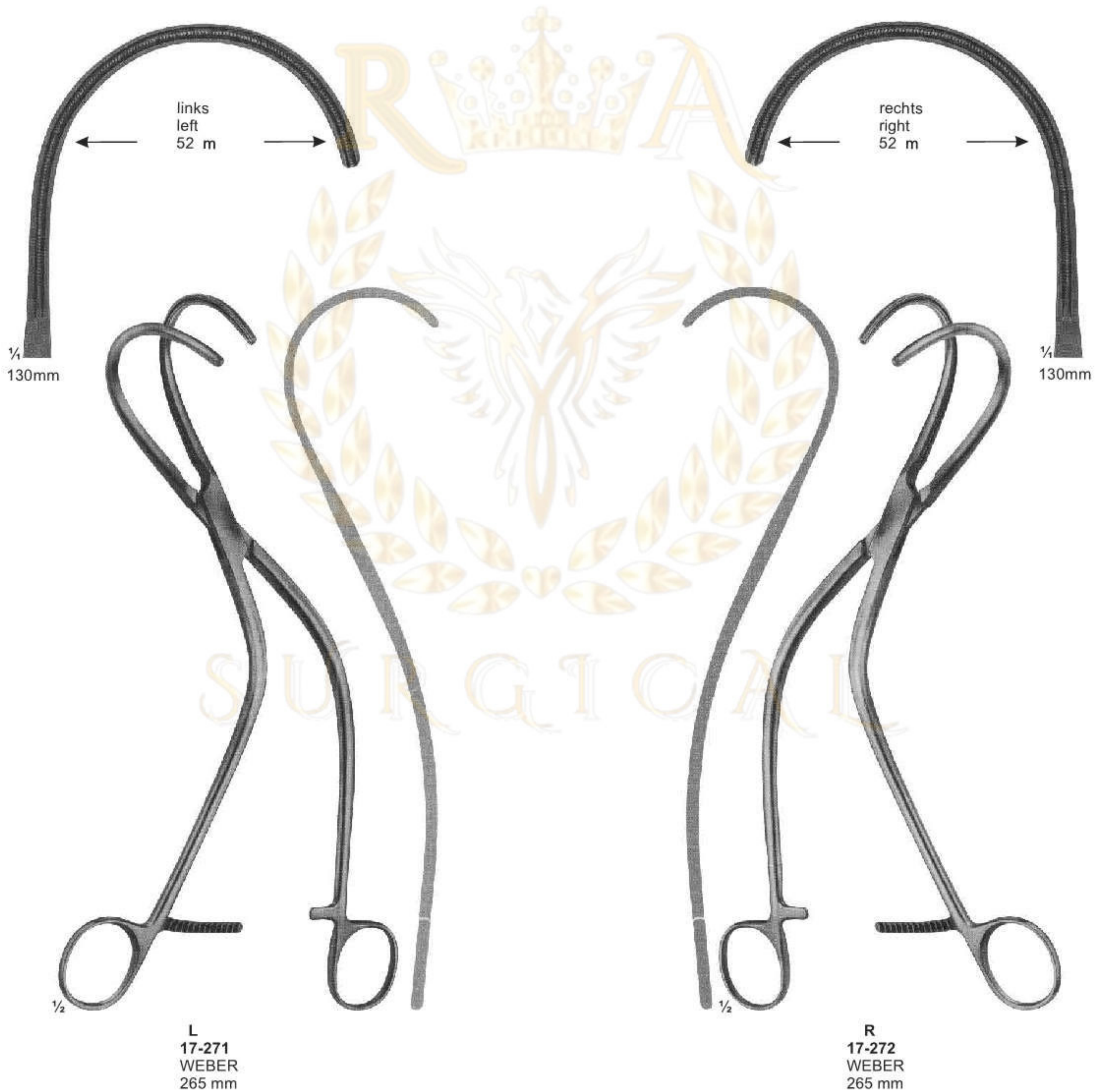

# Aorta-Anastomosis Clamps



Total Length:	230 mm	280 mm	305 mm	240 mm
Length of jaws:	85 mm	100 mm	135 mm	93 mm

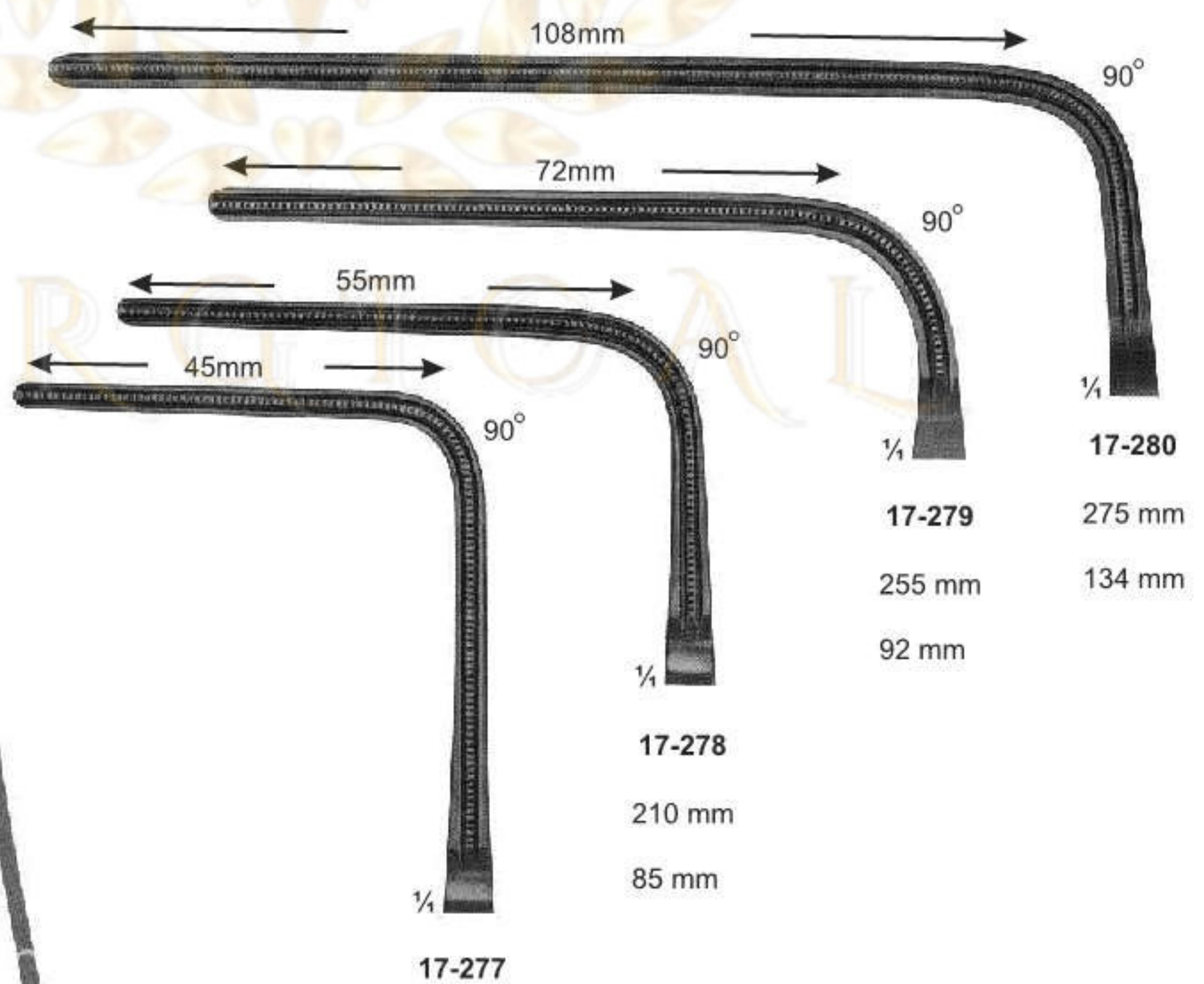

Total Length:	225 mm
Length of jaws:	93 mm

# Aorta-Anastomosis Clamps

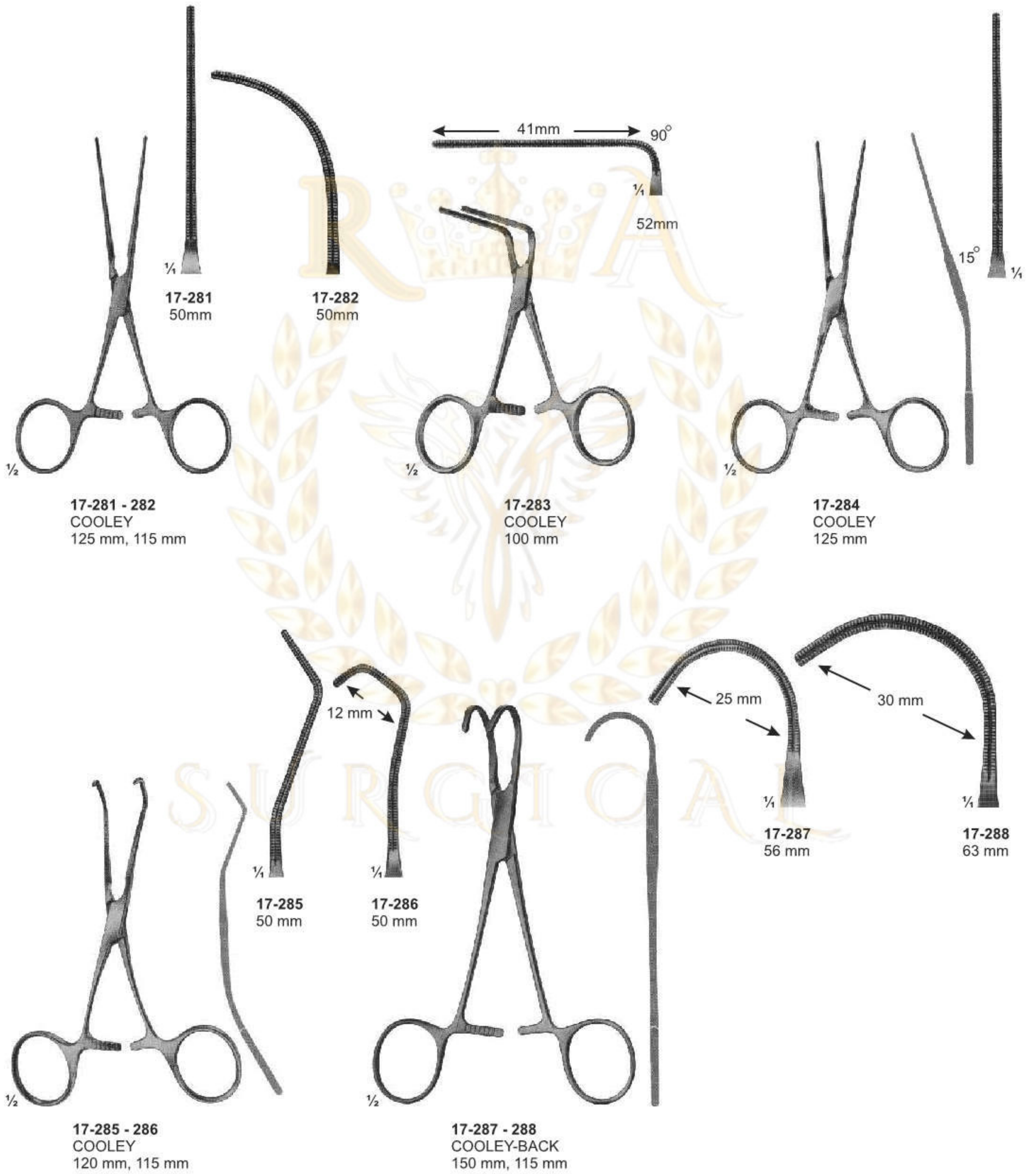

# Aorta-Anastomosis Clamps

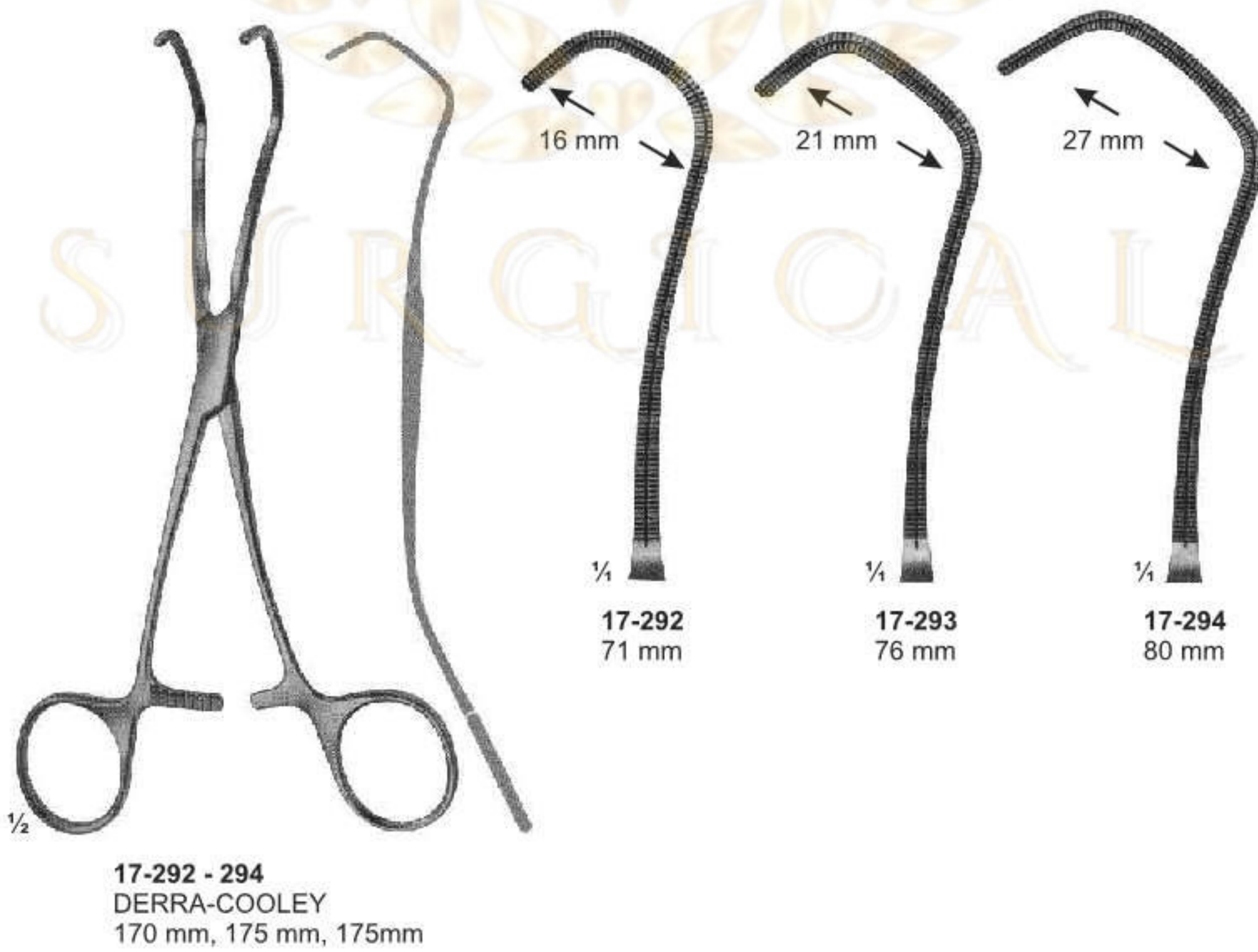

# Aorta-Anastomosis Clamps

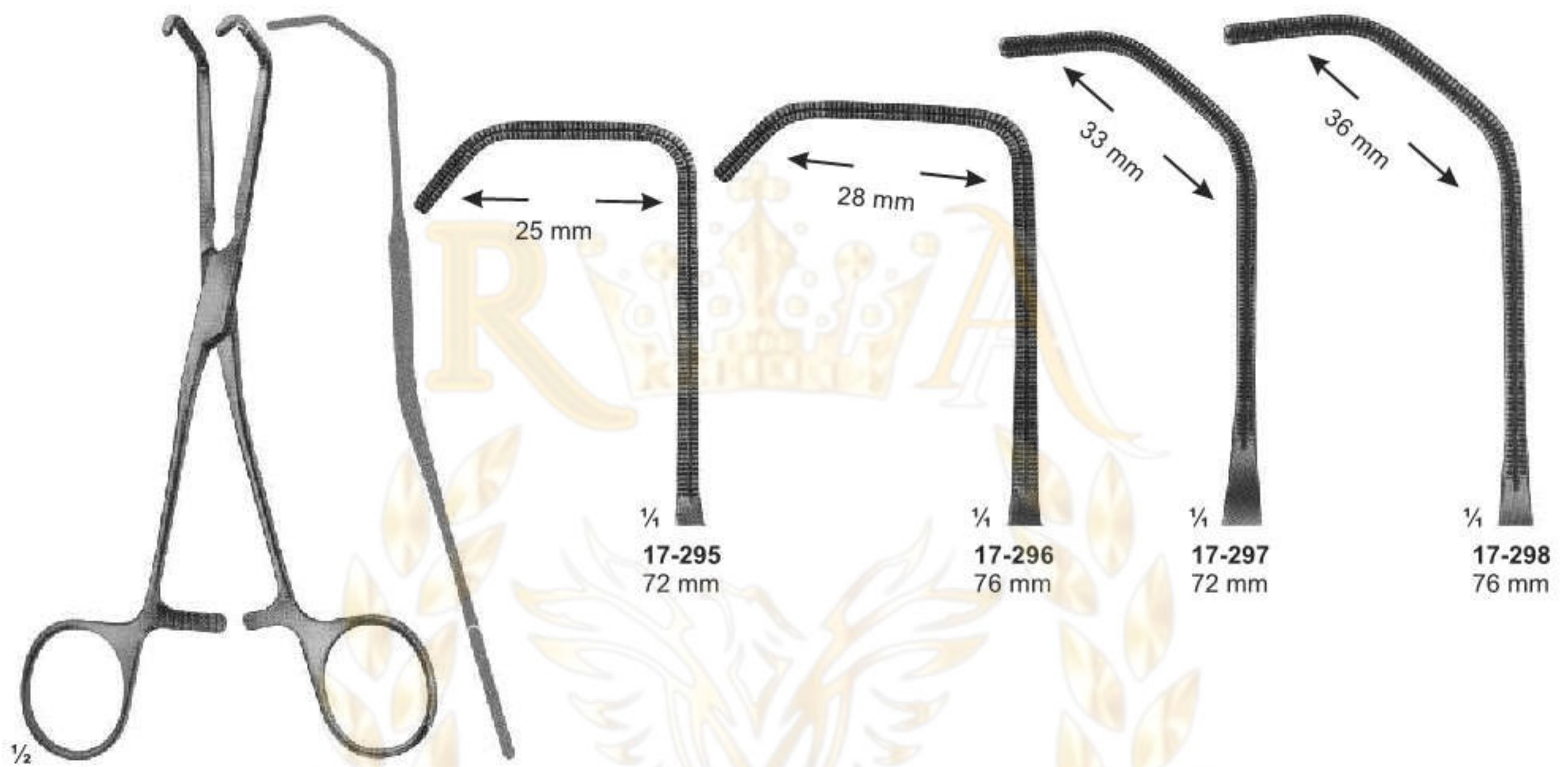

**17-295 - 298**  
**COOLEY**  
 165 mm, 165 mm  
 175 mm, 180 mm

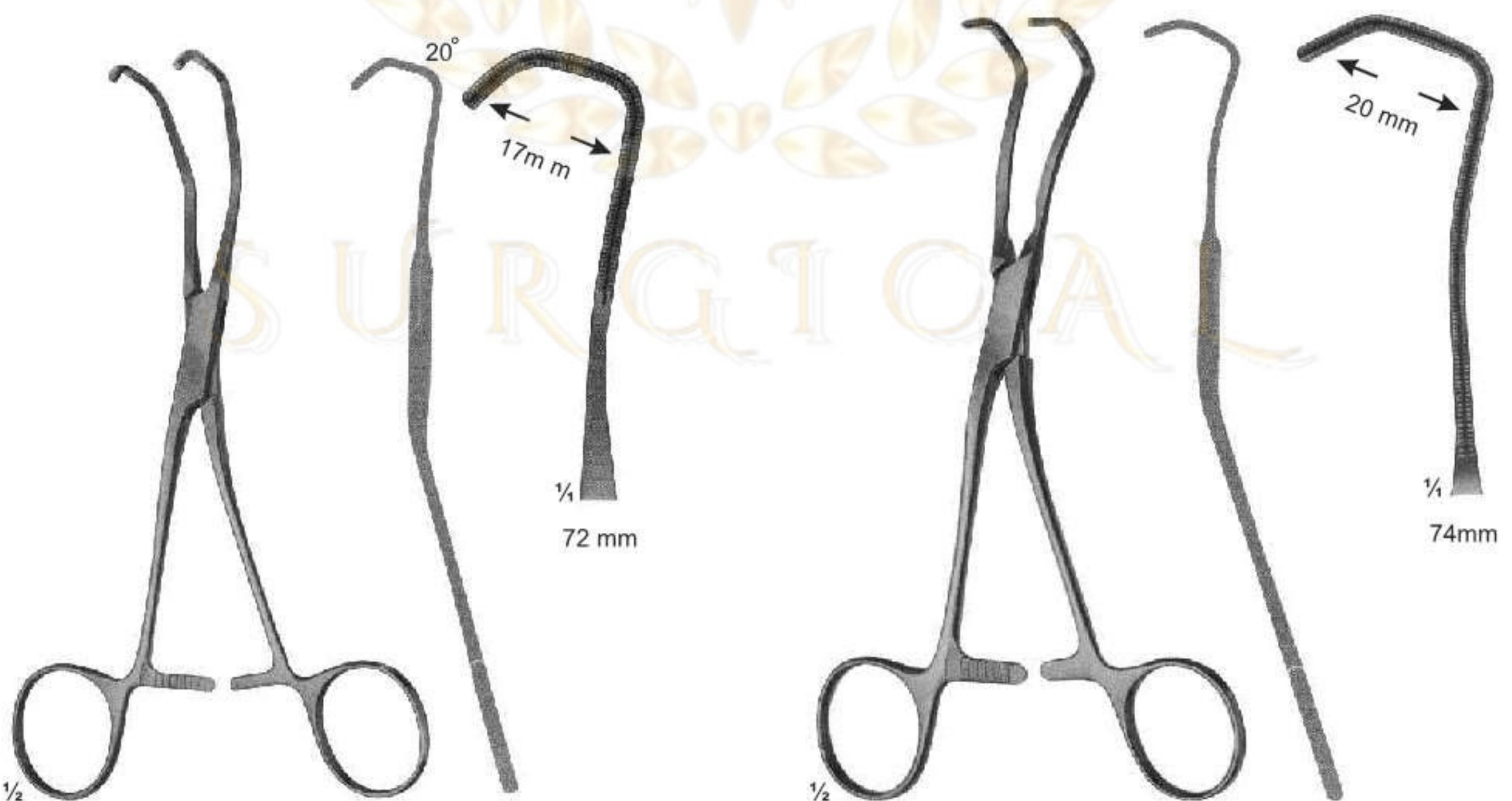

**17-299**  
**COOLEY**  
 170 mm

**17-300**  
**COOLEY**  
 175 mm

# Aorta-Anastomosis Clamps

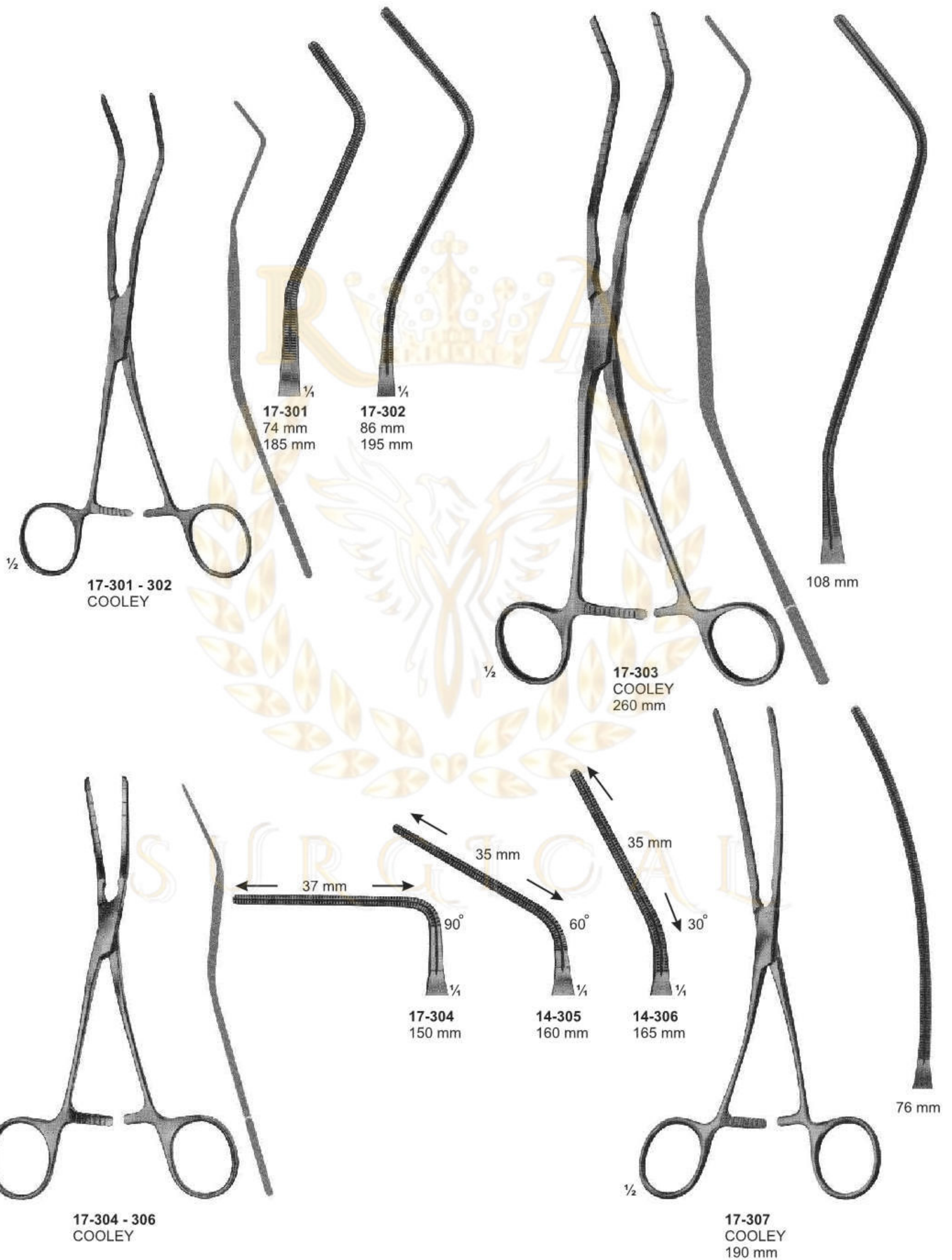

# Aorta-Anastomosis Clamps

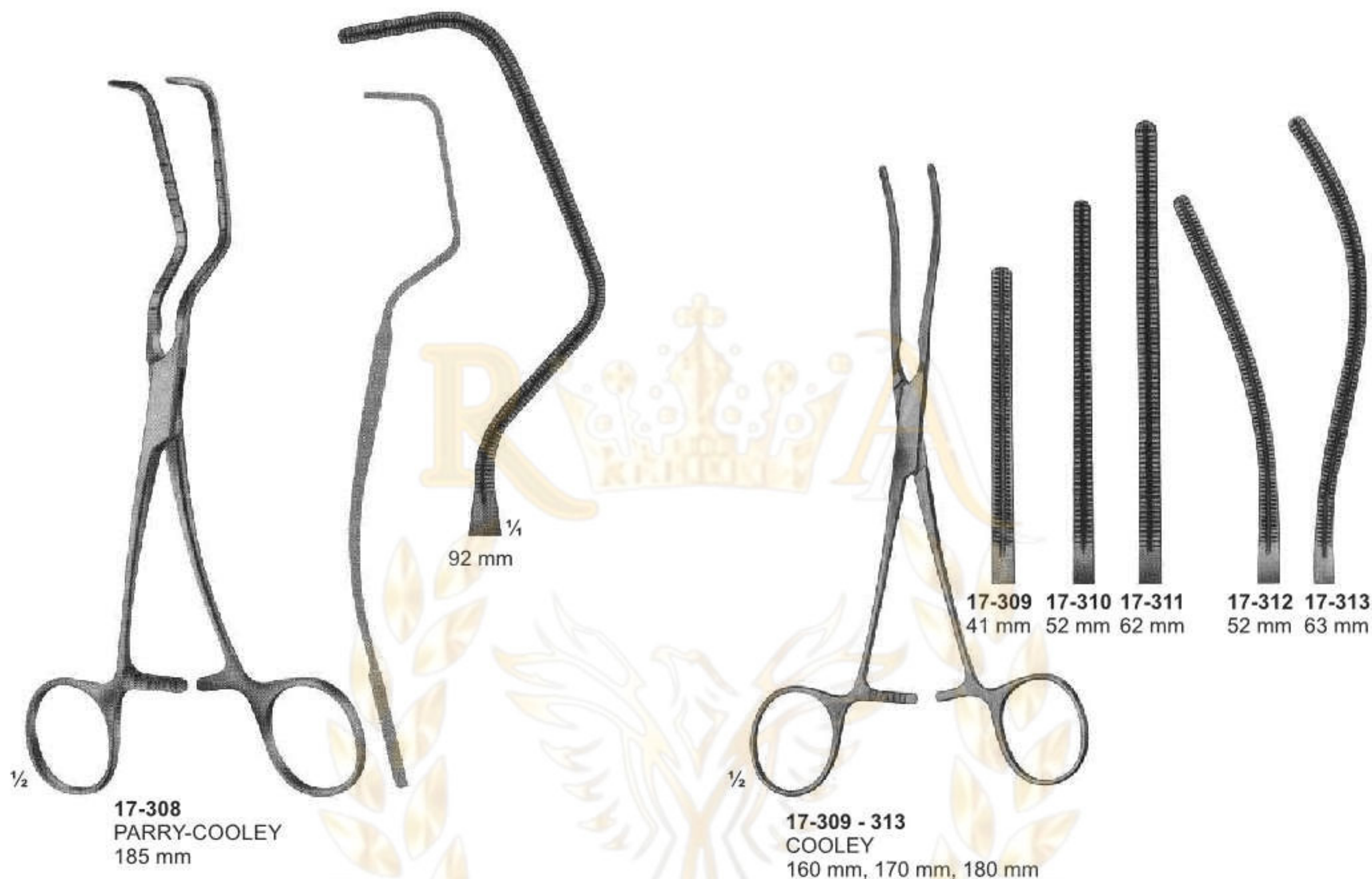

# Multi-Purpose Clamps

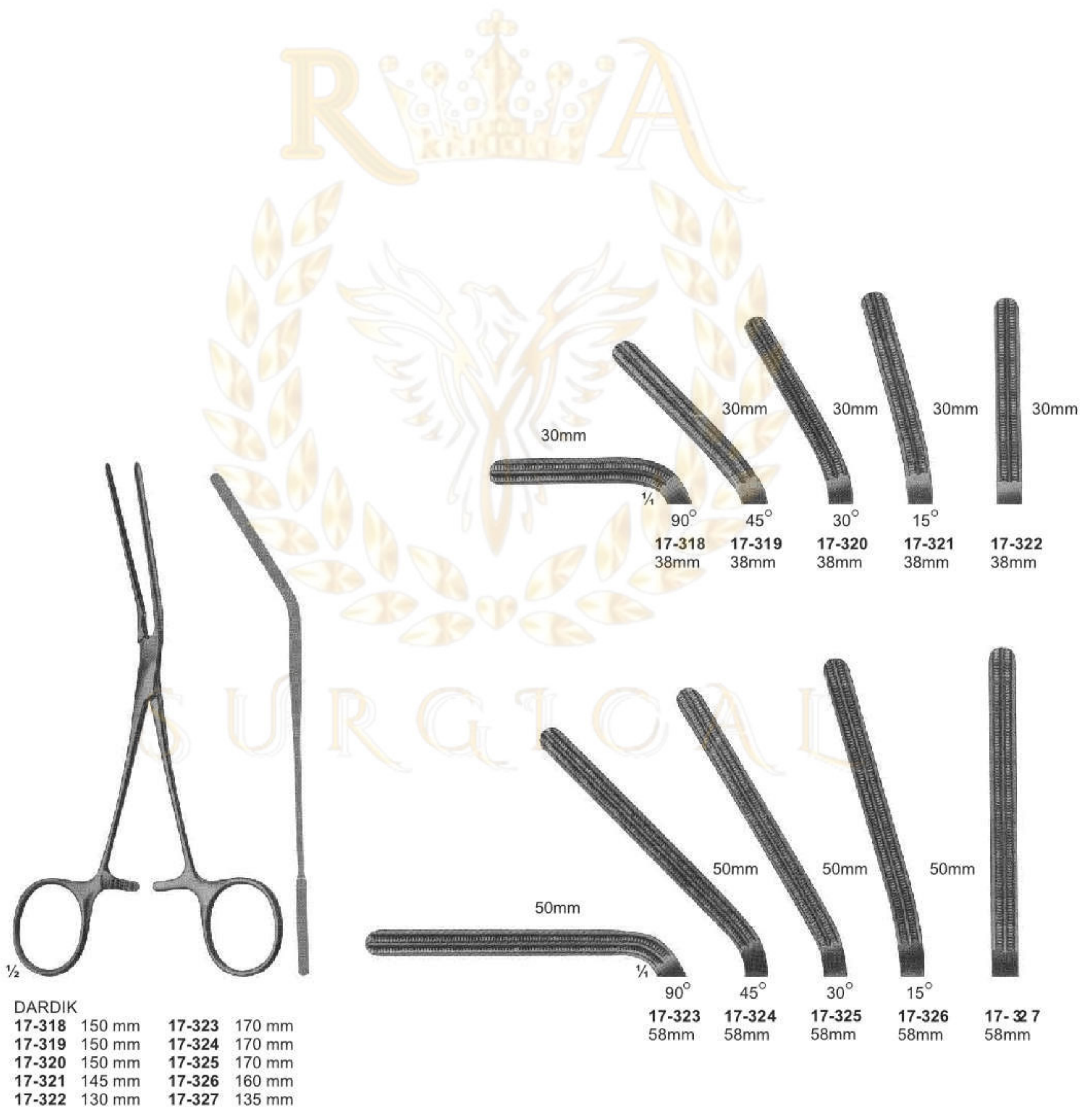

DARDIK			
17-318	150 mm	17-323	170 mm
17-319	150 mm	17-324	170 mm
17-320	150 mm	17-325	170 mm
17-321	145 mm	17-326	160 mm
17-322	130 mm	17-327	135 mm

17-318	38mm	17-319	38mm	17-320	38mm	17-321	38mm	17-322	38mm
17-323	58mm	17-324	58mm	17-325	58mm	17-326	58mm	17-327	58mm



# Multi-Purpose Clamps

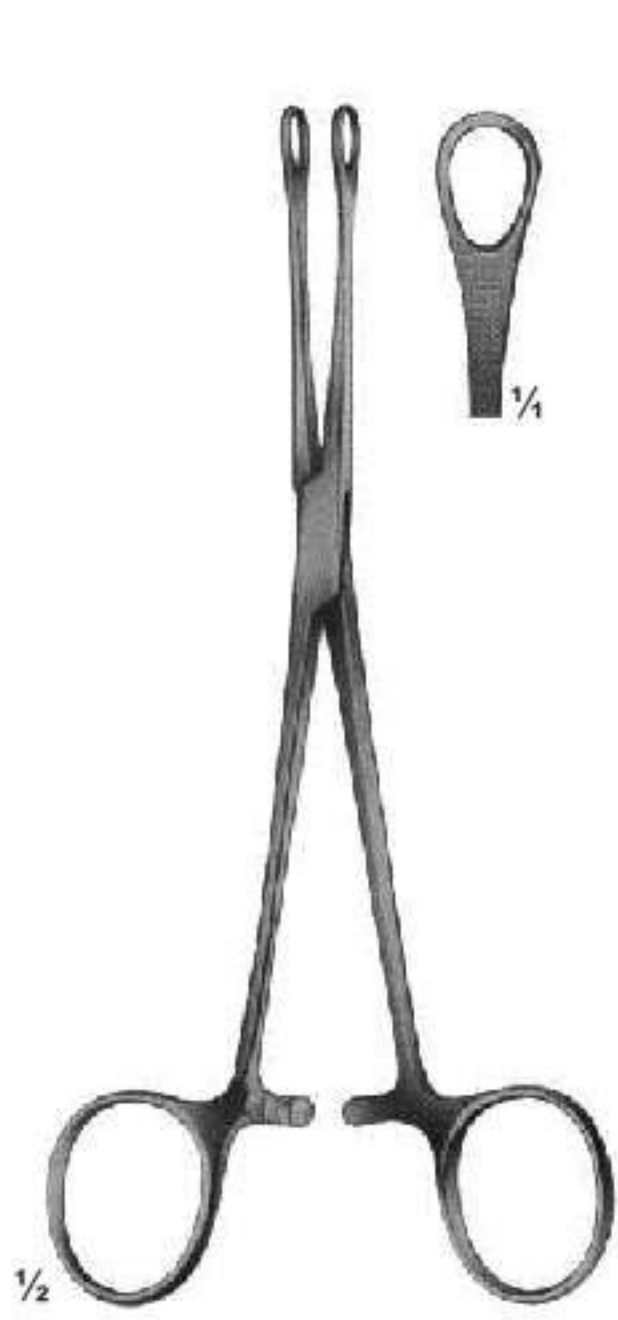

**17-328**  
WILLIAMS  
160 mm



**17-329**  
TUTTLE  
230 mm



**17-330**  
NELSON  
230 mm



**17-331**  
DUVAL  
230 mm

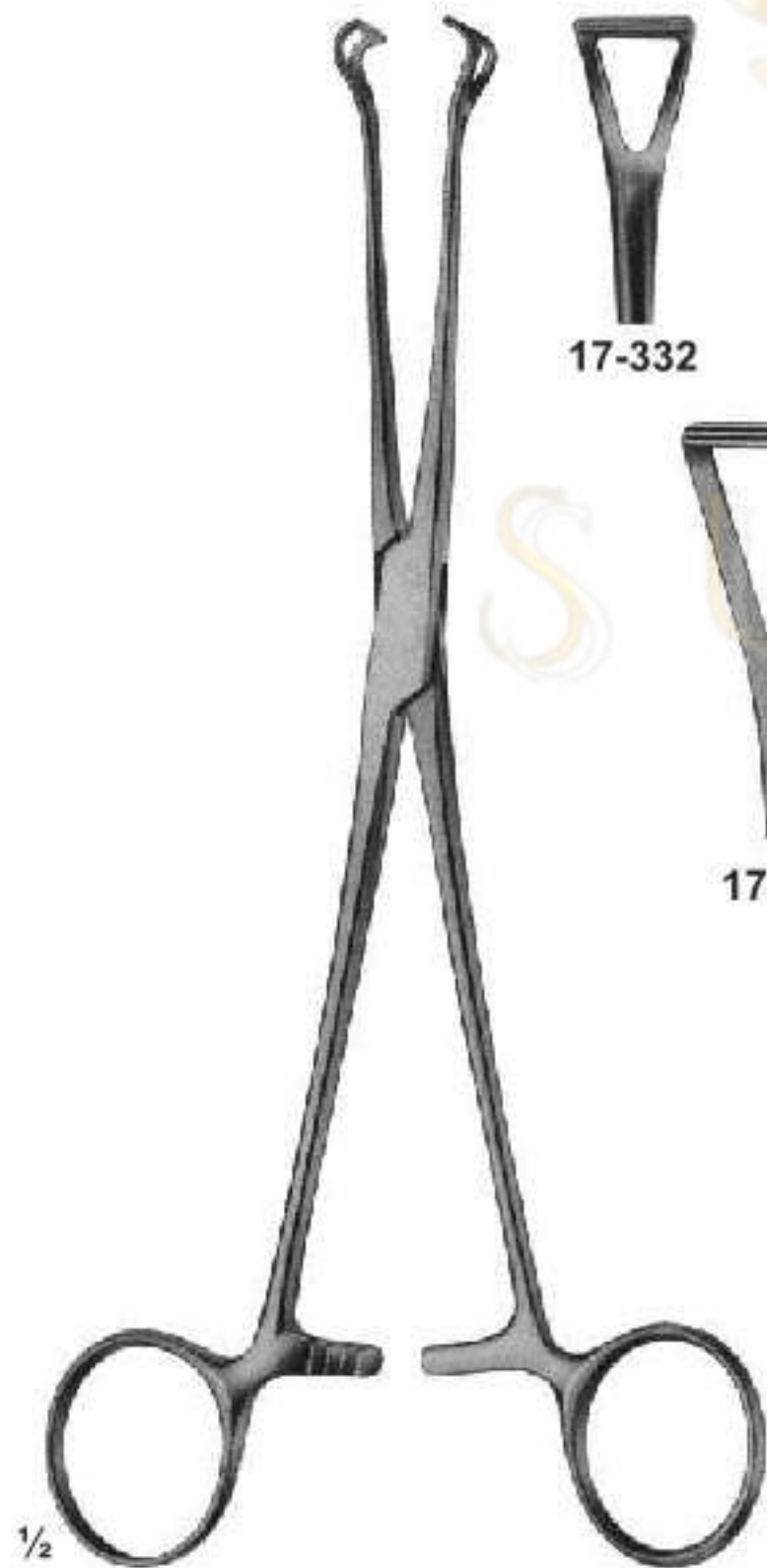

**BABCOCK**  
17-332 170 mm  
17-333 215 mm  
17-334 220 mm



**17-332**



**17-333**



**17-334**



**17-335**  
ALLIS  
220 mm

# Multi-Purpose Clamps



**17-336**  
FINOCHIETTO  
245 mm



**17-337 - 338**  
SEMB  
244 mm



**17-337**



**17-338**

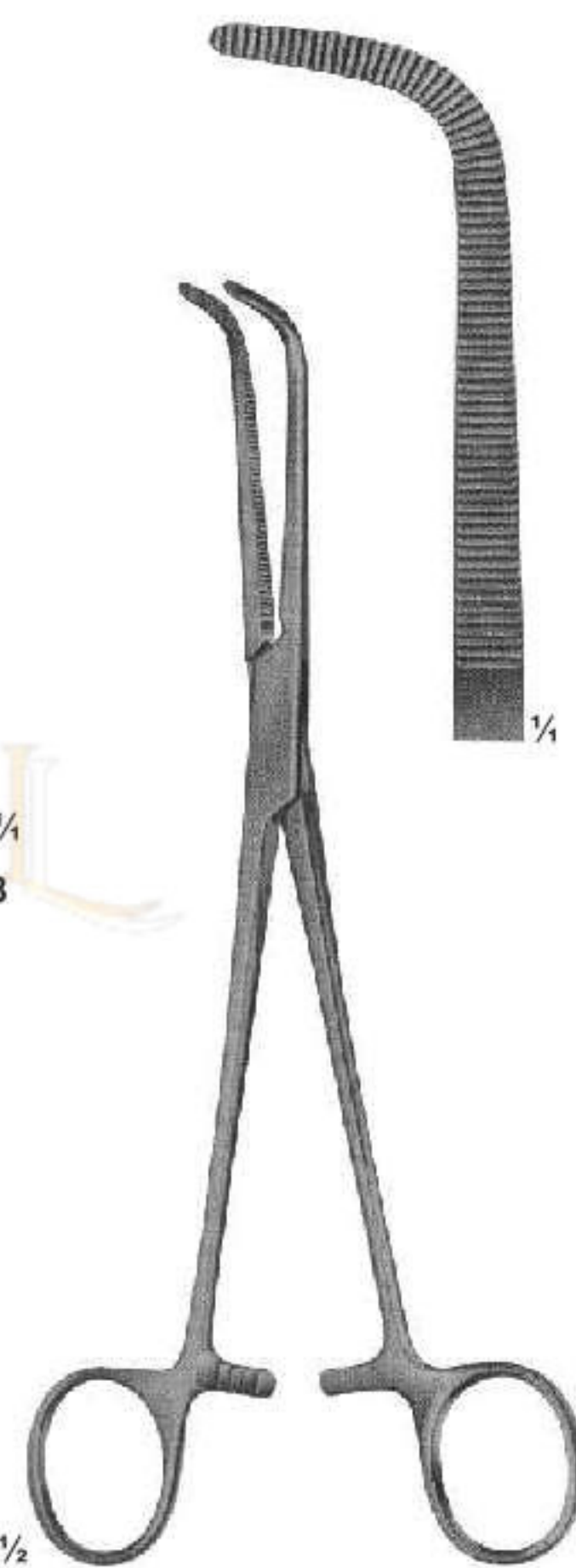

**17-339**  
WIKSTROEM  
205 mm

# Multi-Purpose Clamps



**17-340**  
MIXTER  
230 mm



**17-341 - 342**  
MIXTER



**17-343**  
HOPFNER  
160 mm

# Multi-Purpose Clamps



**17-344**  
SATINSKY  
265 mm



**17-345**  
SATINSKY  
265 mm



**17-346**  
HARKEN  
240 mm

# Multi-Purpose Clamps



17-347  
PERTUISET  
Carotid Clamp  
90 mm



17-348  
CRAFOORD-SELLORS  
240 mm



17-349 - 350  
CRAFOORD  
240 mm

# Multi-Purpose Clamps



**17-351**  
PRICE THOMAS  
225 mm



**17-352 - 353**  
PRICE THOMAS  
225 mm



**17-352**  
jaws with pins



**17-353**  
jaws with pins

# Rib Shears



17-354  
SCHUMACHER  
Sternum shears  
210 mm



17-355  
LEBSCHE  
Sternum chisel  
200 mm



17-356  
230 mm



17-357  
COLLIN  
195 mm



17-358  
GLUCK  
190 mm



17-359  
GLUCK  
190 mm



17-360  
BRUNNER  
Universal Pattern  
340 mm



17-361  
GIERTZ-STILLE  
250 mm

# Rib Holding Forceps, Bone Cutting Forceps

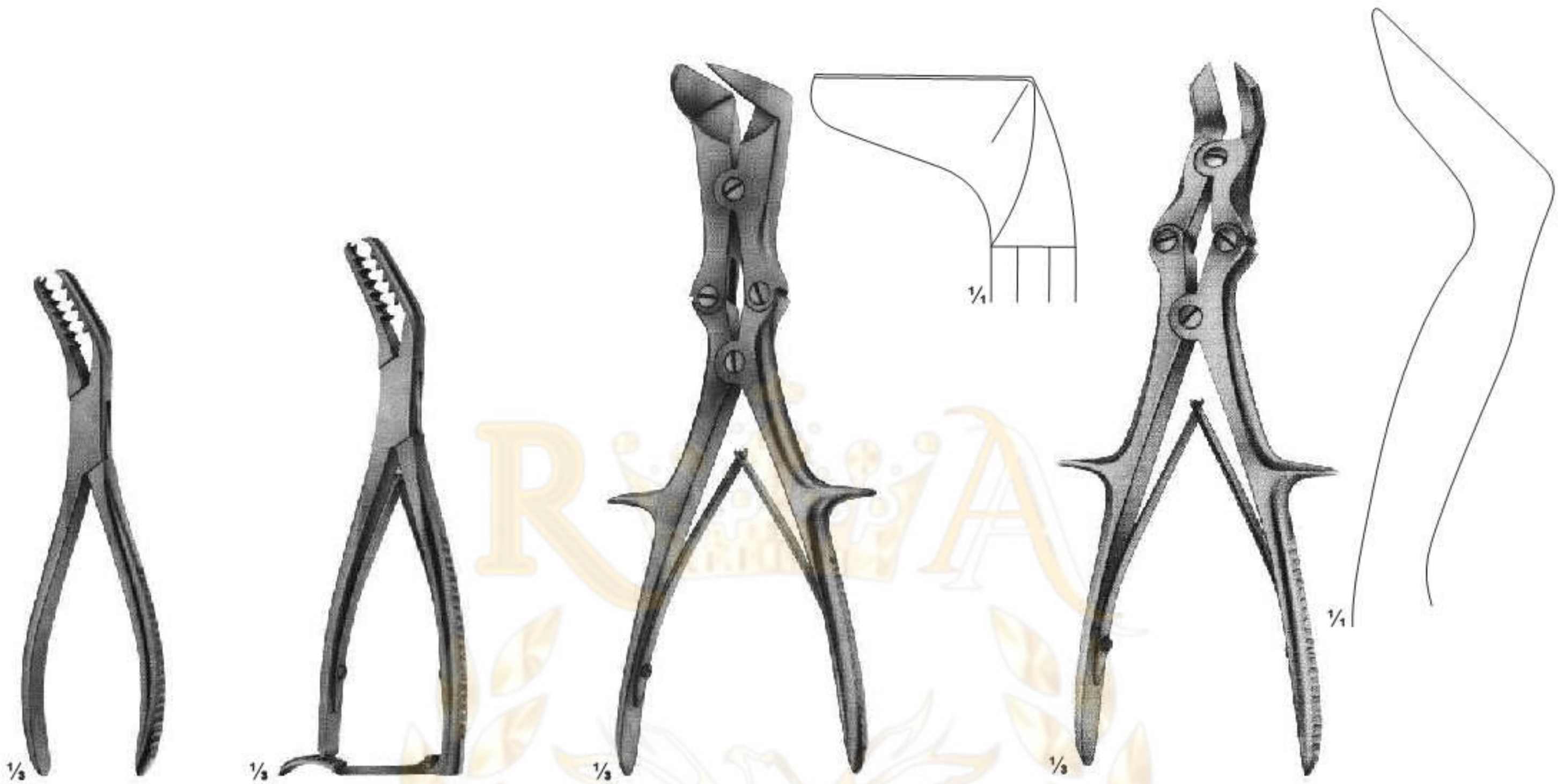

**17-362**  
SEMB  
Rib-and Bone  
Holding forceps  
190 mm

**17-363**  
SEMB  
Rib-and Bone  
Holding forceps  
190 mm

**17-364**  
LISTON-STILLE  
265 mm

**17-365**  
LISTON-KEY-HORSLEY  
255 mm



**17-367**

**17-368**

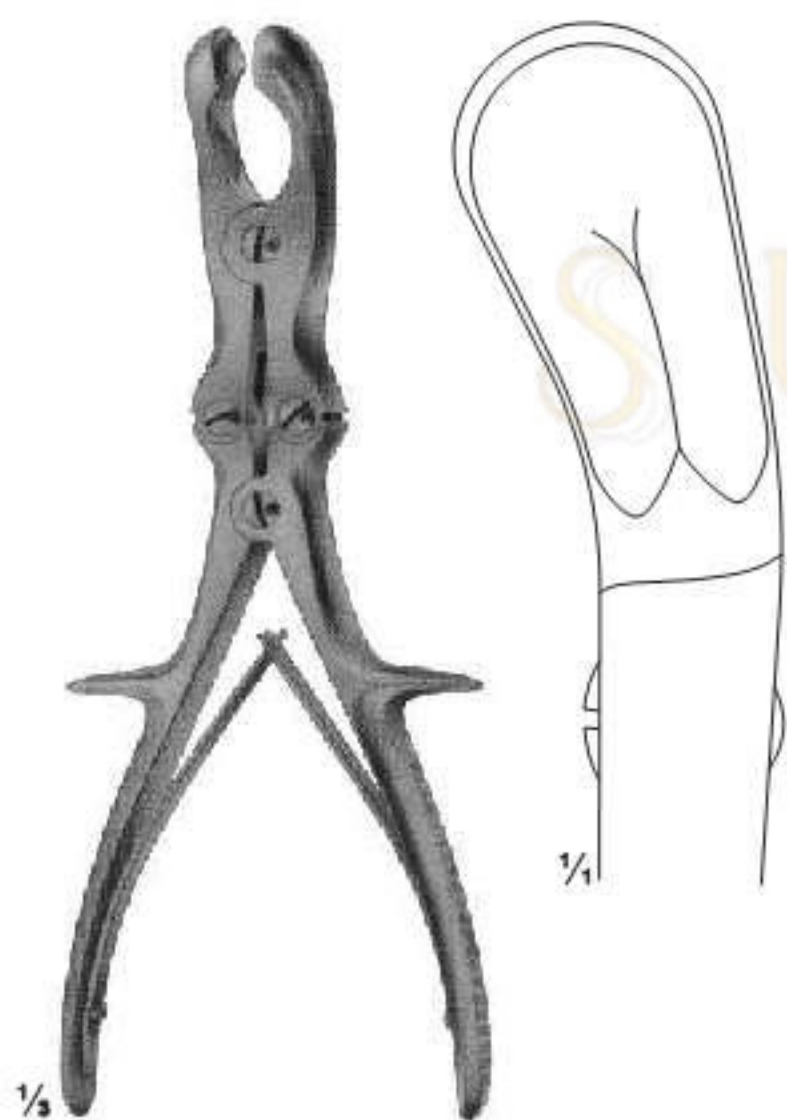

**17-366**  
SEME  
Rib Rongeur to shorten  
the rib stumps  
240 mm



**17-367-368**  
SAUERDRUCH-CORYLLOS  
Rib rongeurs to shortn  
the rib stumbes  
310 mm

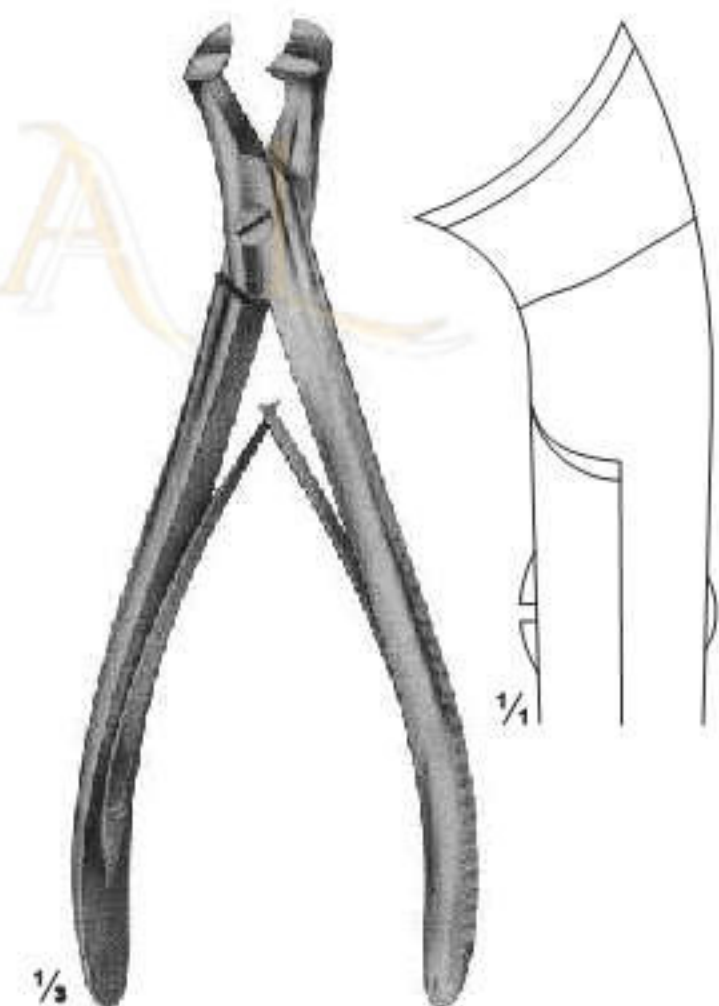

**17-369**  
MARKWALDER  
Rib Rongeur to Round  
the rib stumps  
190 mm



# Rib Raspatories



17-370 - 371  
DOYEN  
for children  
175 mm

17-372 - 373  
DOYEN  
for adults  
175 mm

17-374 - 375  
DOYEN  
240 mm

# Rib Raspatories



# Rib Spreaders



# Rib Spreaders



# Rib Spreaders

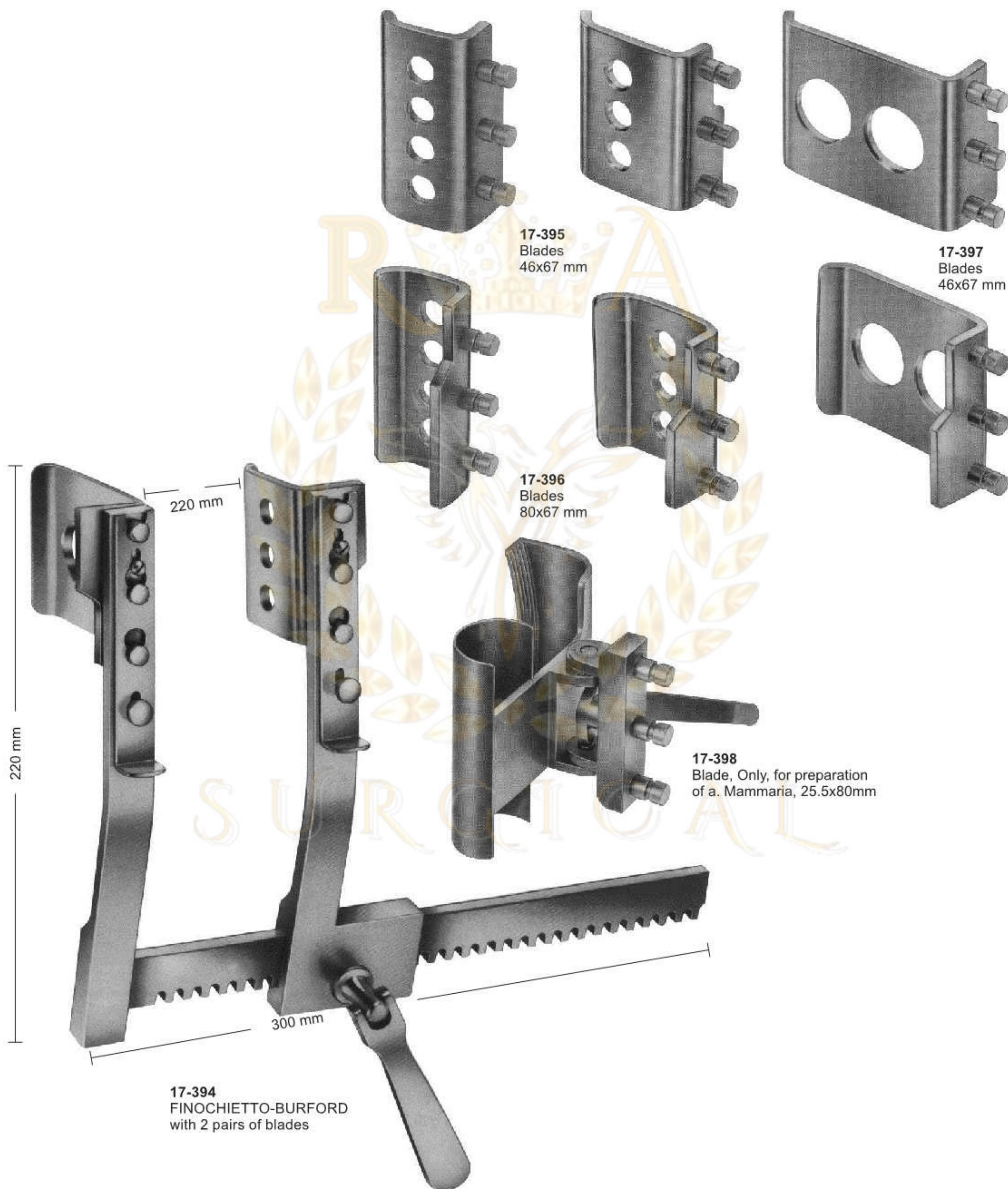

**17-395**  
Blades  
46x67 mm

**17-397**  
Blades  
46x67 mm

**17-396**  
Blades  
80x67 mm

**17-398**  
Blade, Only, for preparation  
of a. Mammaria, 25.5x80mm

**17-394**  
FINOCHIETTO-BURFORD  
with 2 pairs of blades

# Rib Spreaders

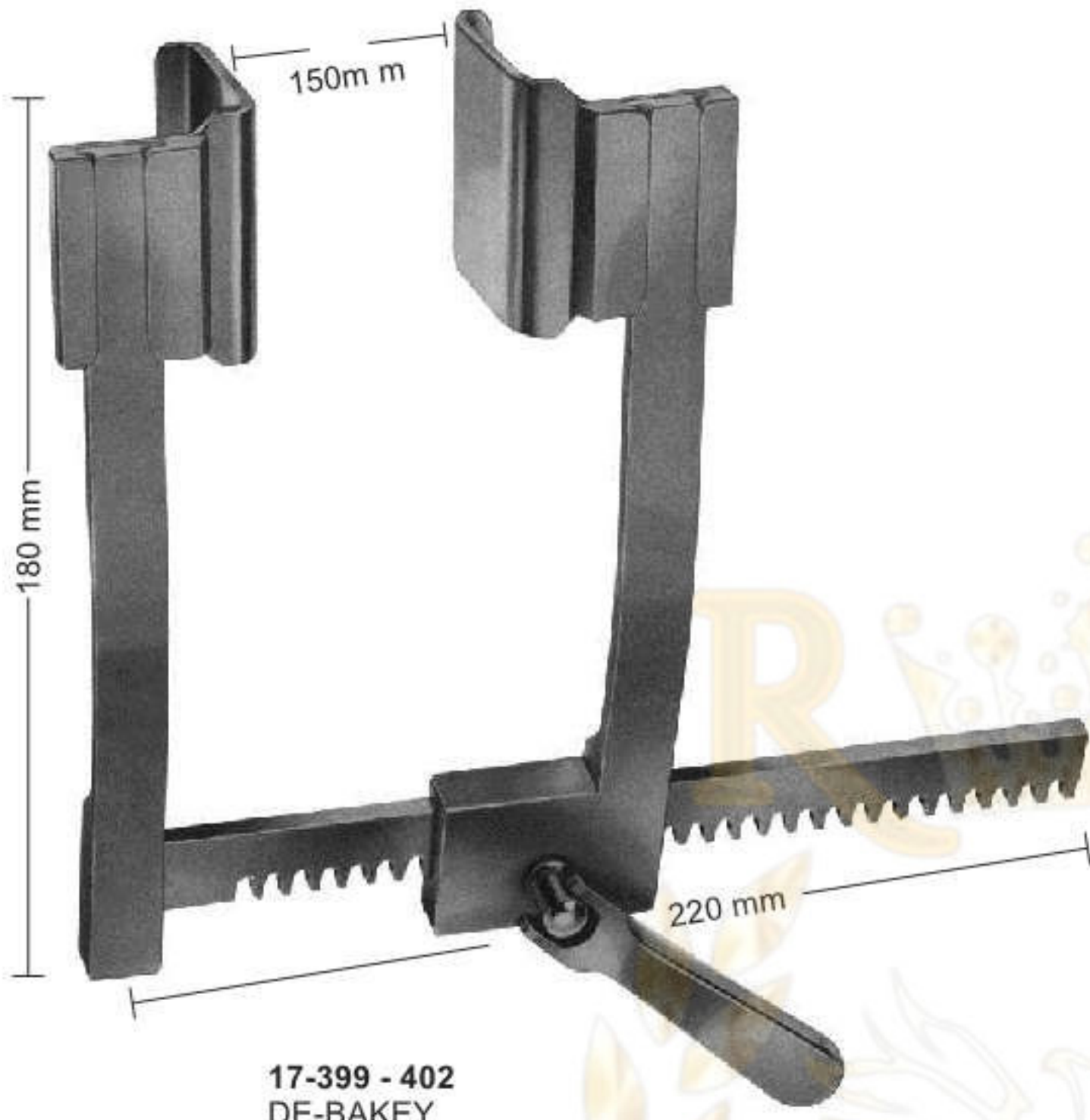

**17-399 - 402**  
DE-BAKEY  
with 3 pairs of blades



**17-400**  
Blades  
30x30 mm



**17-401**  
Blades  
40x40 mm



**17-402**  
Blades  
50x50 mm



**17-404**  
Blades  
50x80 mm



**17-405**  
Blades  
80x60 mm

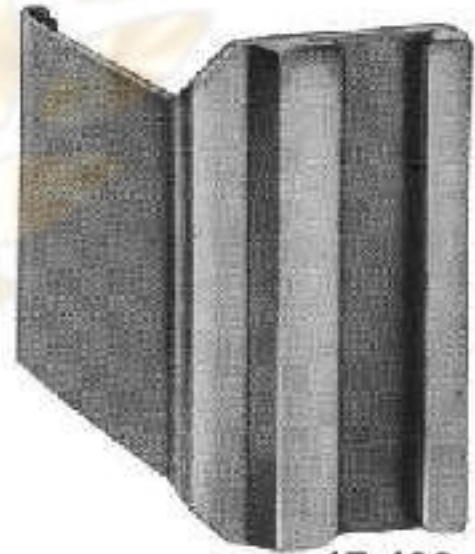

**17-406**  
Blades  
50x80 mm

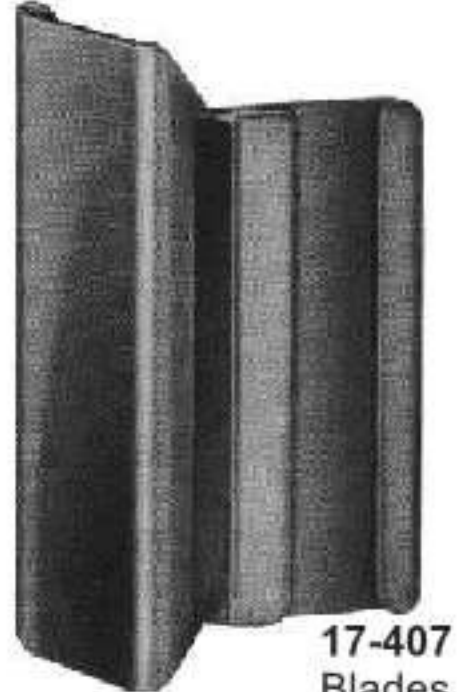

**17-407**  
Blades  
40x100 mm



**17-403 - 408**  
DE-BAKEY  
with 3 pairs of blades



**17-408**  
Sternotomy Blades  
50x660 mm

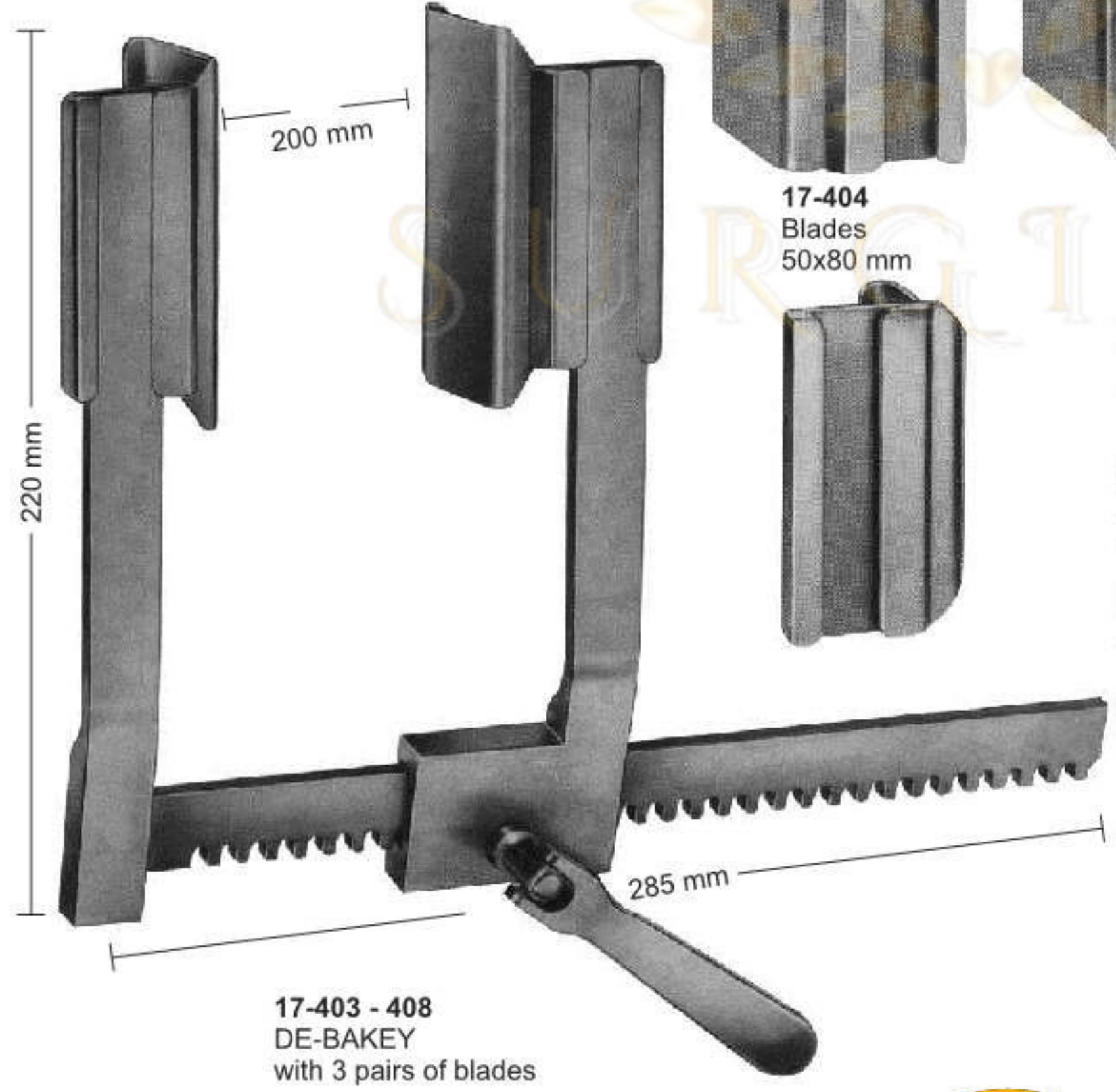

# Sternotomy Spreaders



**17-409**  
MORSE  
Sternotomy spreader  
for children, with moveable  
double, each blade  
12x20 mm



**17-410**  
MORSE  
Sternotomy spreader  
for adults, with moveable  
double, each blade  
19x19 mm

# Sternotomy- Spreaders

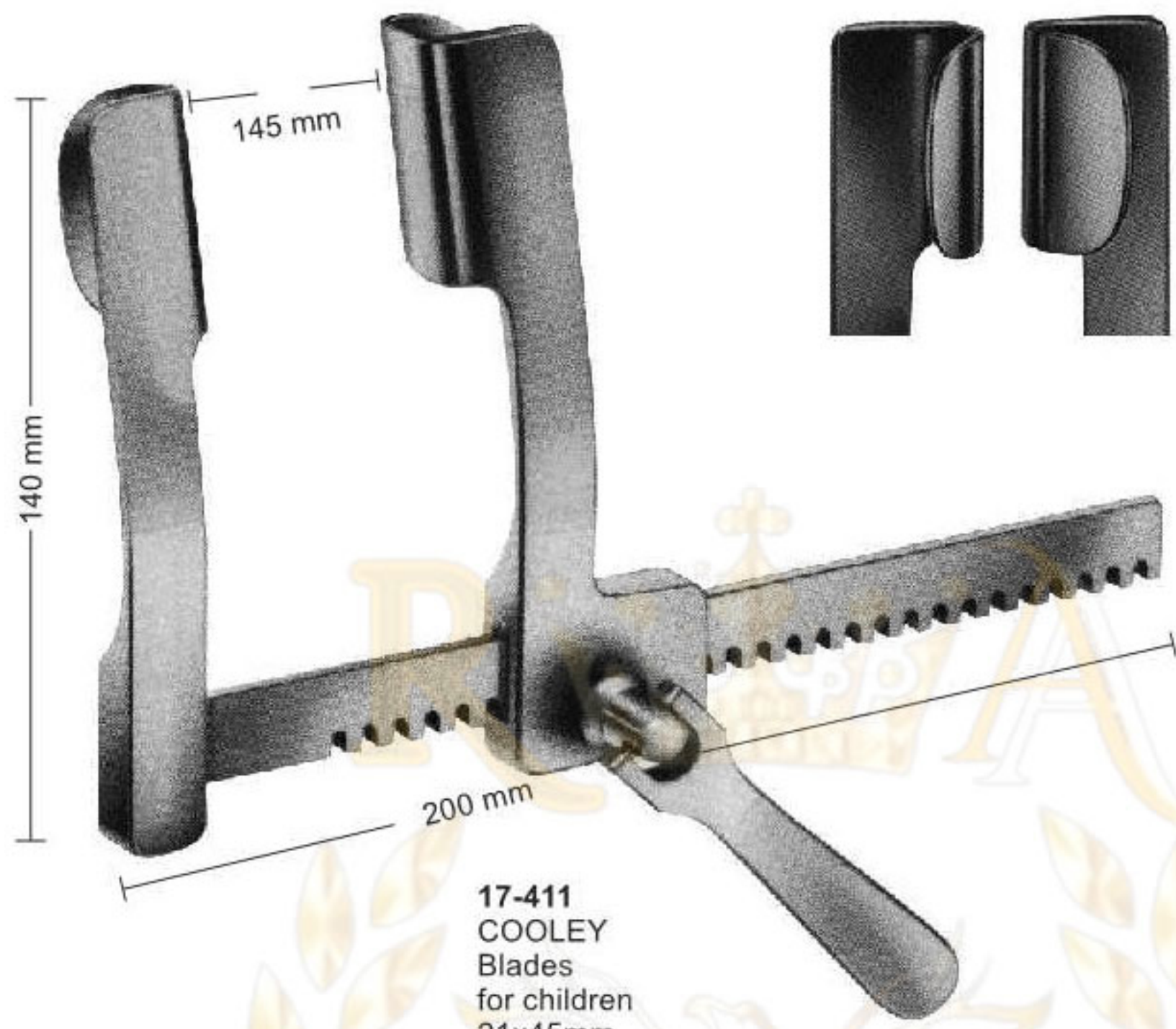

**17-411**  
COOLEY  
Blades  
for children  
21x45mm

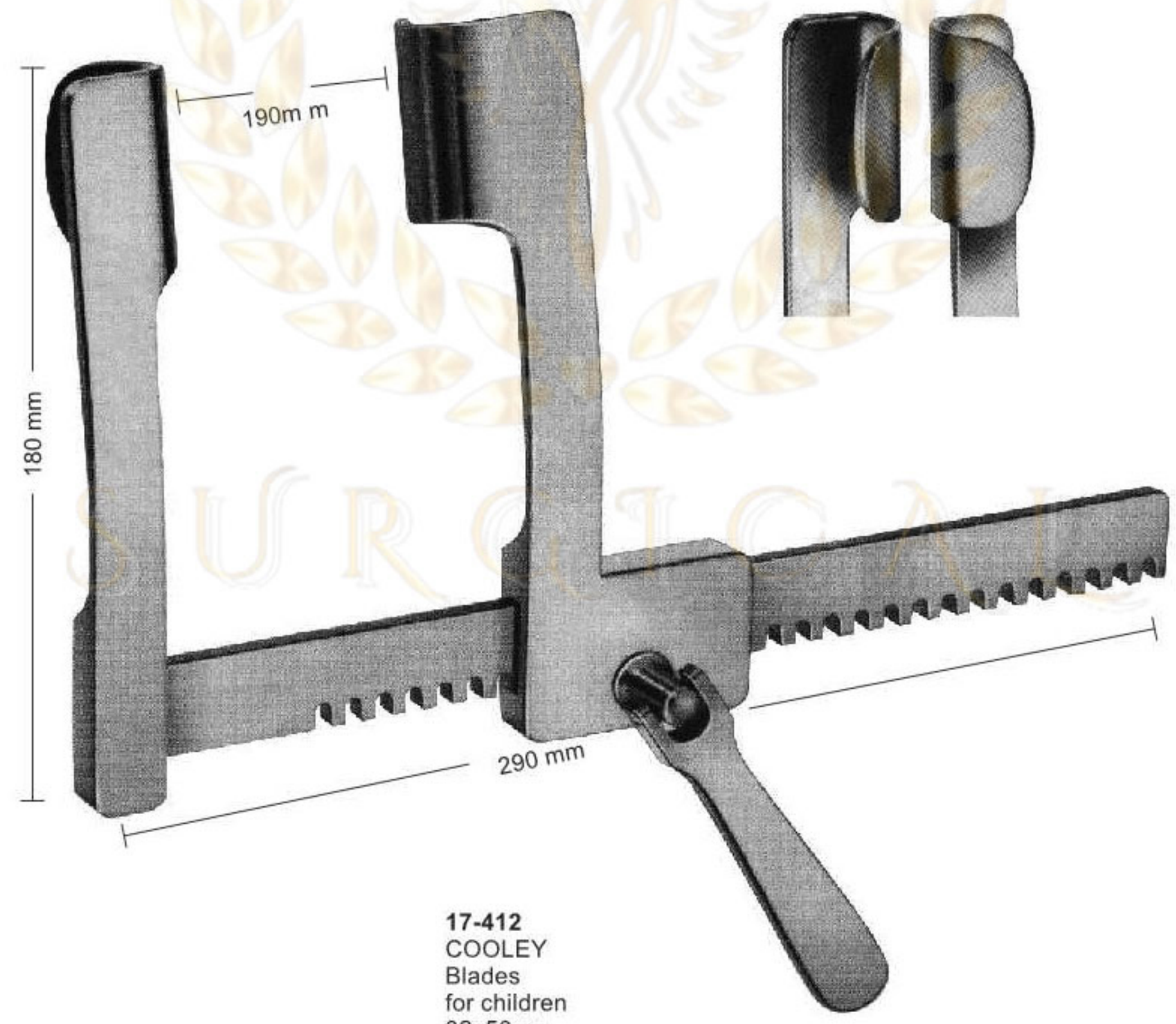

**17-412**  
COOLEY  
Blades  
for children  
32x50mm



# Thoracic Retractors



**17-414**  
Blades  
75x75 mm

**17-415**  
Blades  
42x65 mm

Blades with Ball Snap System  
Delivery: in Pairs

- 17-413 - 415**  
Thoraxsperrer (Mercedes-Sperrer)  
complete consisting of:  
**17-413** Retractor only  
**17-414** 1 Pair of blades 42x65 mm  
**17-415** 1 Pair of blades 75x75 mm

# Rib Spreaders-and Contractors



**17-416**  
SELLORS  
Rib spreader-and contractor  
with swivel blades  
200 mm



**17-417**  
BAILEY  
150 mm



**17-418**  
for children

**17-418 - 419**  
BAILEY  
200 mm



**17-419**  
for children

# Rib Spreaders-and Contractors

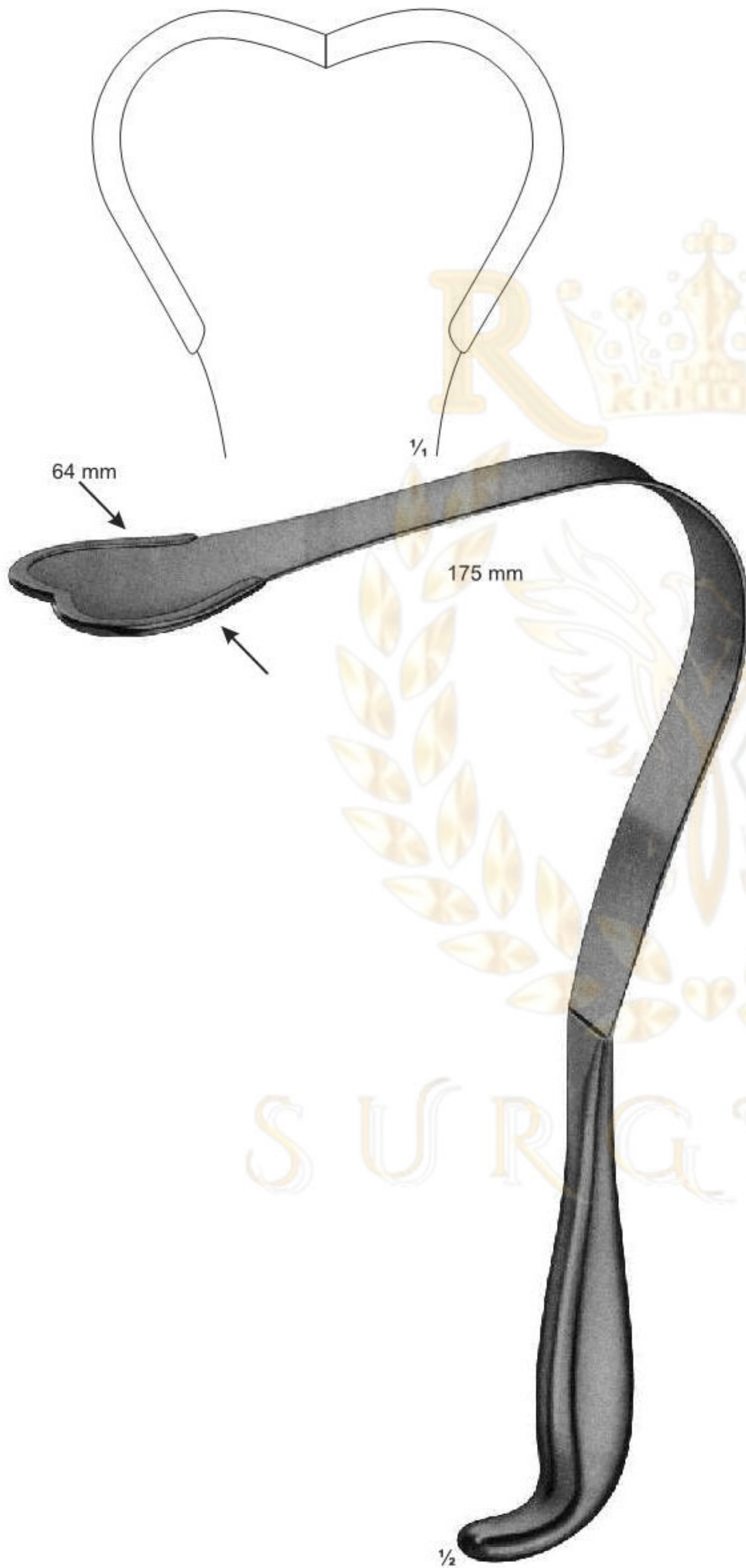

**17-420**  
HARRINGTON-PEMBERTON  
federnd/flexible  
295 mm



**17-421**  
DAVIDSON  
Scalpel haken

# Rib Spreaders-and Contractors



17-422  
ALLISON  
255 mm



17-423  
ALLISON  
320 mm



17-424  
DE BAKHEY  
With central bore,  
3.0mm diam.  
with lateral slots  
275 mm



17-425  
YANKAUER  
With central bore,  
2.0mm diam.  
285 mm

# Punches

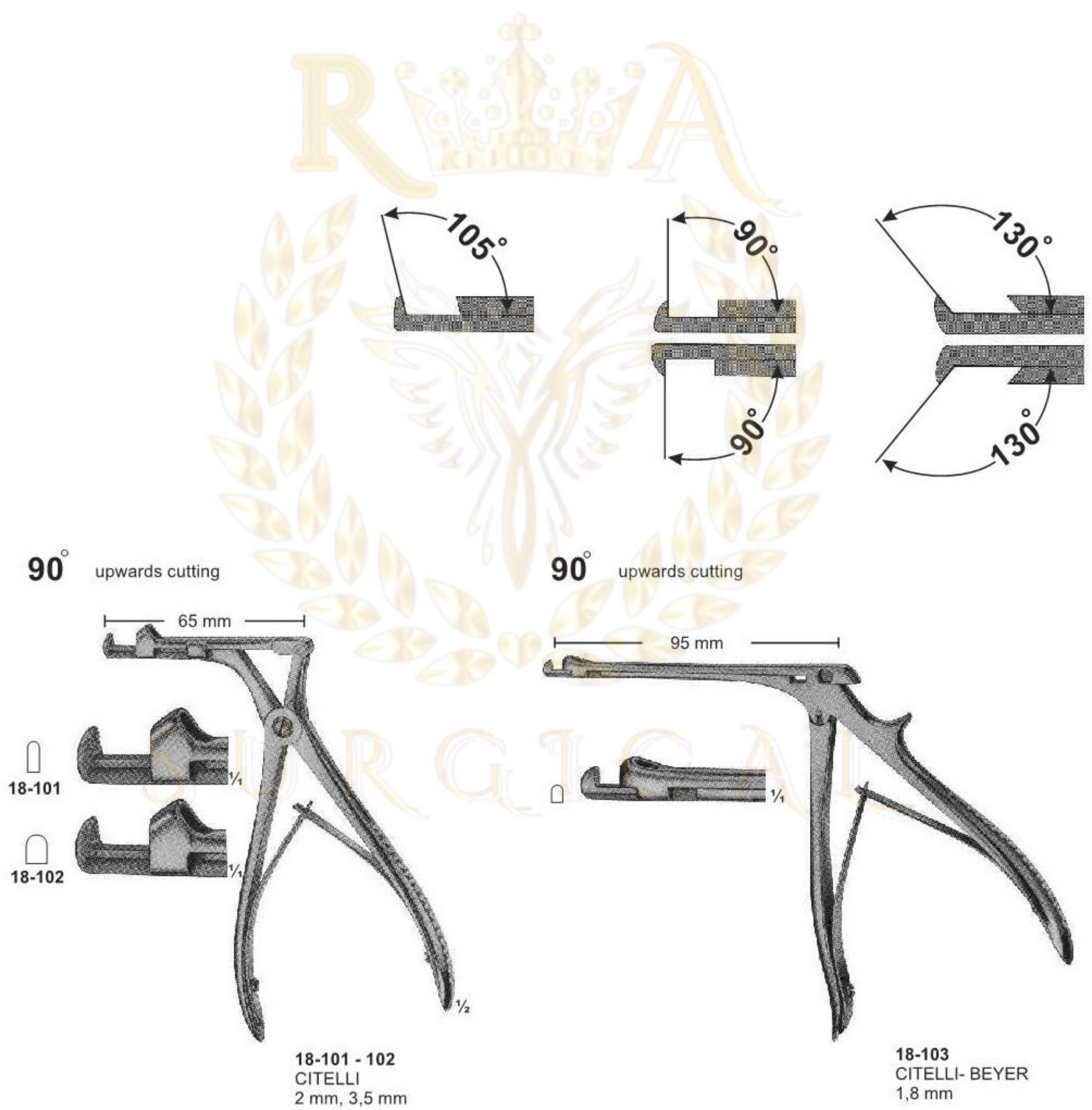

# Punches

90° upwards cutting

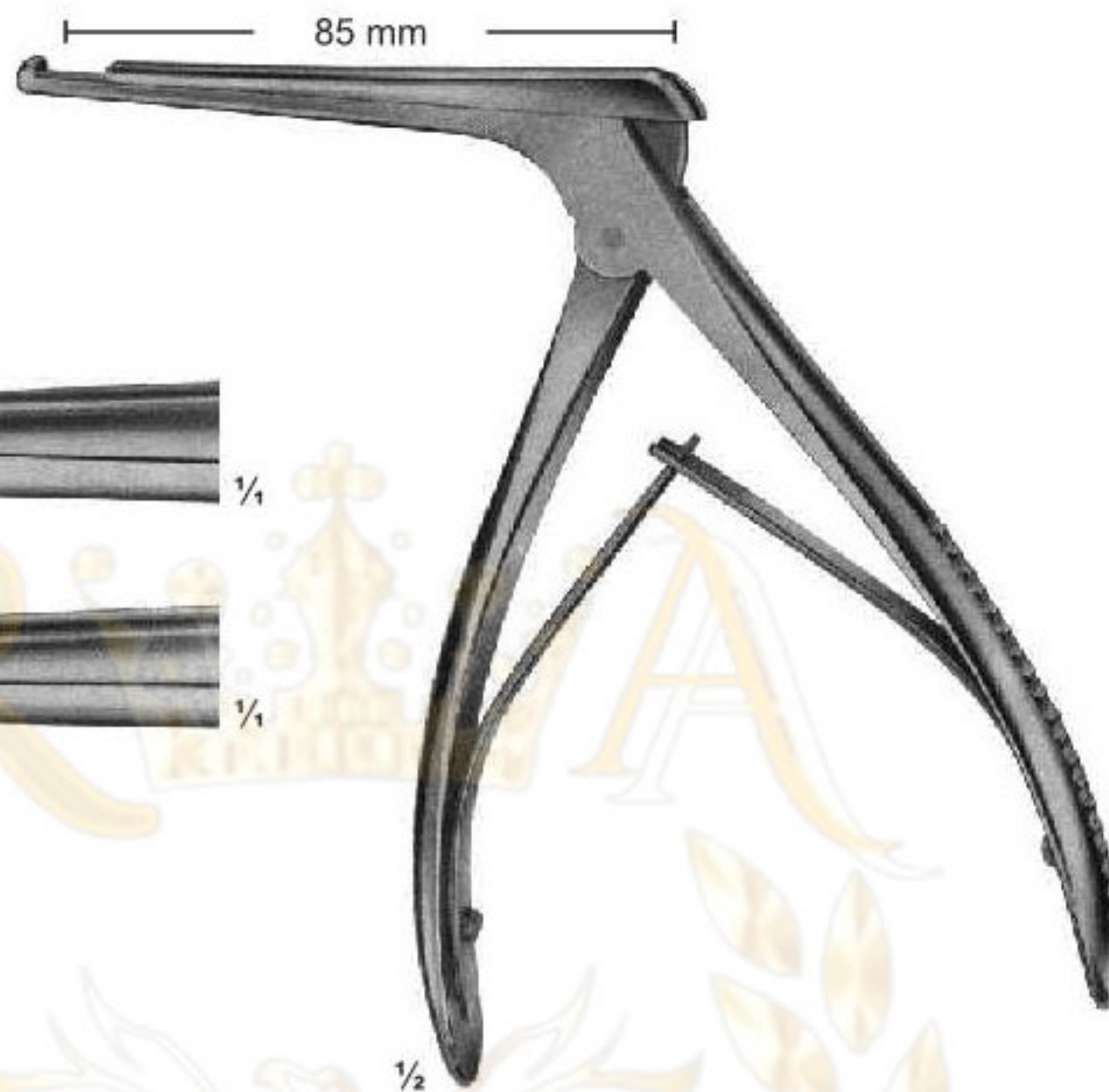

18-104  
4 mm



18-105  
5 mm



18-104 - 105  
KERRISON

90° upwards cutting



18-106  
3,3 mm



18-107  
4,0 mm



18-106 - 107  
HAJEK-KOFLER

# Punches

**130°** upwards cutting

**18-108**  
1 mm



140 mm

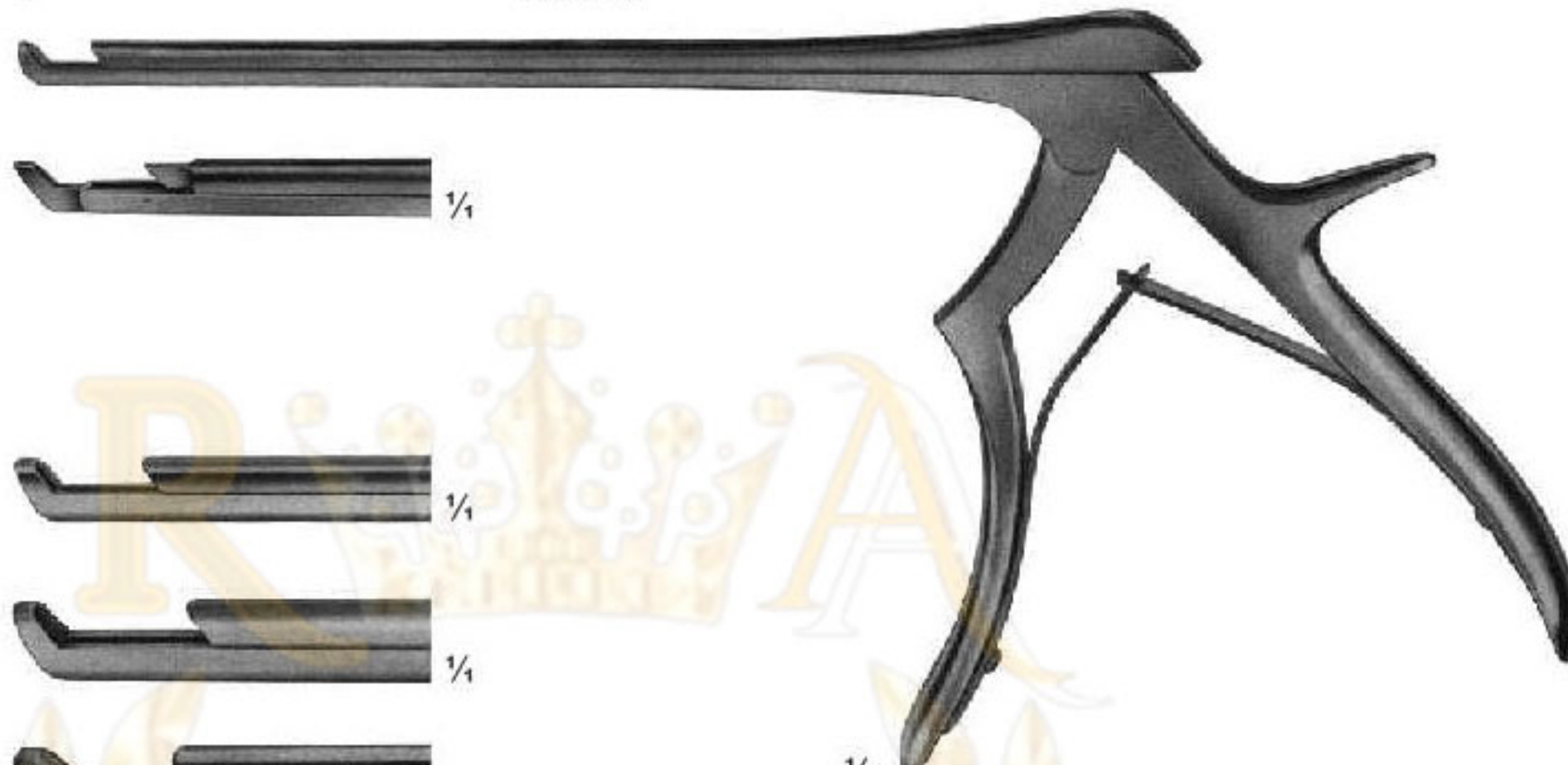

**18-109**  
2 mm



**18-110**  
3 mm



**18-111**  
4 mm



**18-112**  
5 mm



**18-108 - 112**  
KERRISON-JACOBY

**90°** upwards cutting

**18-113**  
1 mm



**18-114**  
2 mm



FERRIS-SMITH-KERRISON

**18-115**  
3 mm



**18-116**  
4 mm



**18-117**  
5 mm



180 mm



**18-113 - 117**  
KERRISON-JACOBY

# Rongeurs

Angled positions for rongeurs

- 18-118  
3,0 mm
- 18-119  
3,6 mm
- 18-120  
4,2 mm
- 18-121  
4,8 mm
- 18-122  
5,8 mm



18-118 - 122  
WEIL-BLAKESLEY



18-123  
TAKAHASHI  
3 mm

130°

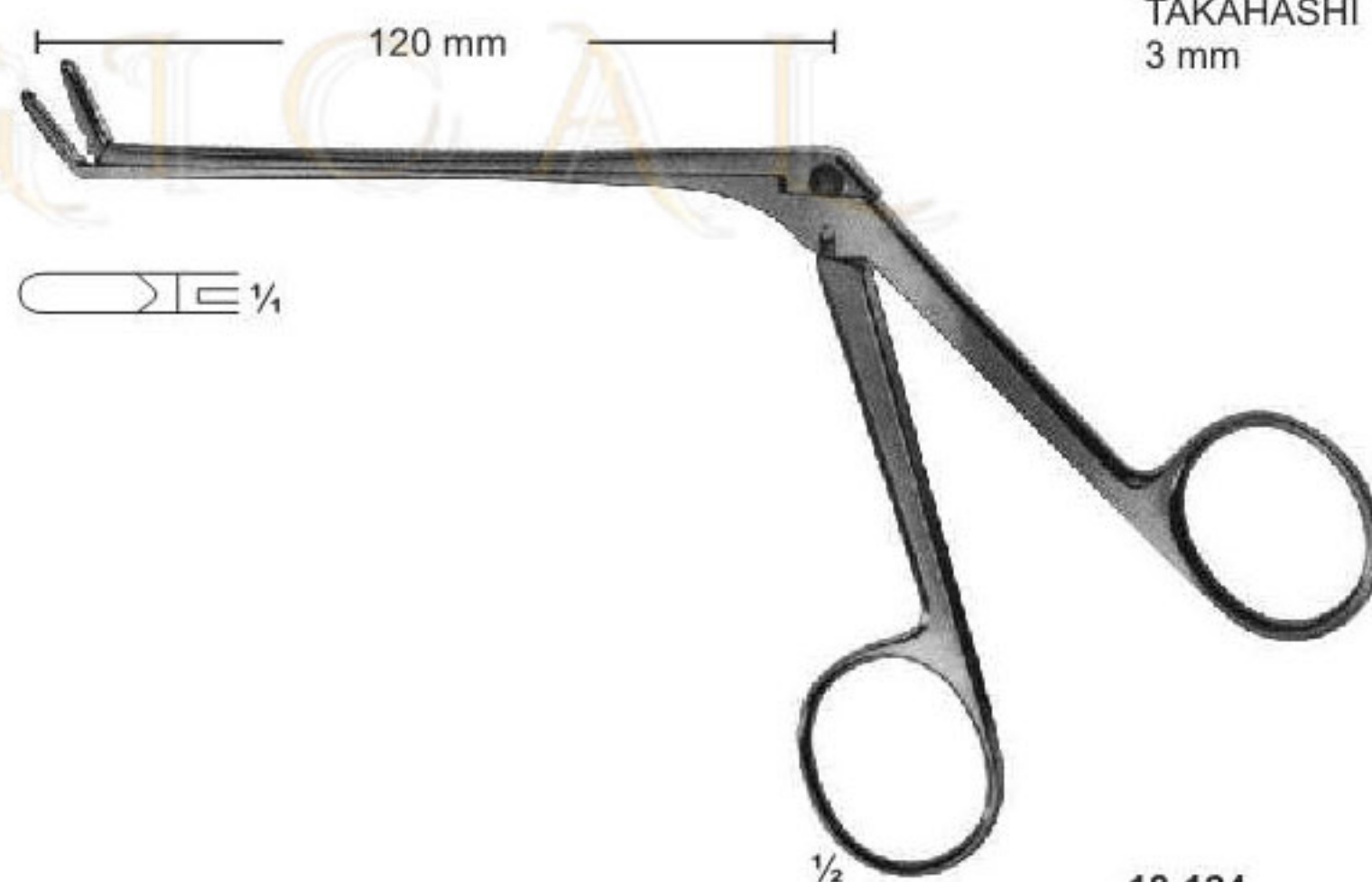

18-124  
TAKAHASHI  
3 mm



# Rongeurs

**18-125**  
2 X 10 mm



**18-126**  
3 X 10 mm



**18-127**  
4 X 10 mm

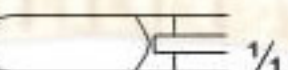

**18-125 - 127**  
LOVE-GRUENWALD

**18-128**  
2 mm

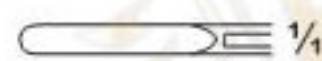

**18-129**  
3 mm



**18-130**  
4 mm



**18-131**  
5 mm



**18-128 - 131**  
CASPAR

**18-132**  
2 mm



**18-133**  
3 mm



**18-134**  
4 mm

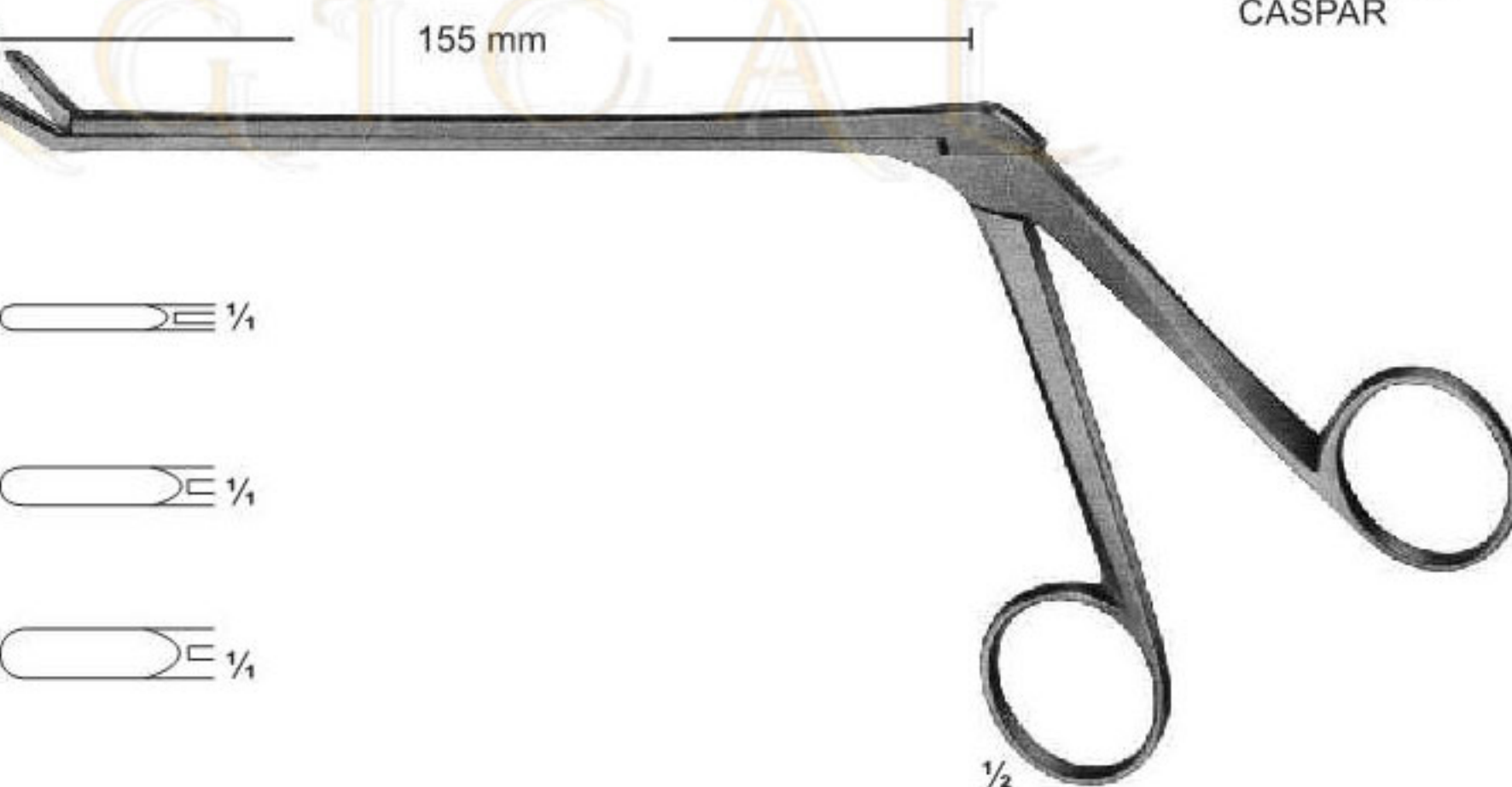

**18-132 - 134**  
CASPAR

# Rongeurs

155 mm

18-135  
2 mm

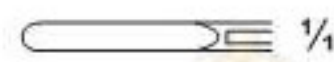

18-136  
3 mm

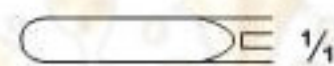

18-137  
4 mm

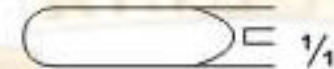

1/2

18-135 - 137  
CASPAR

Length of shaft  
140 mm

Length of shaft  
160 mm

Length of shaft  
185 mm

size of jaws

18-138

18-143

18-148

2 X12 mm



18-139

18-144

18-149

3 X12 mm



18-140

18-145

18-150

4 X14 mm



18-141

18-146

18-151

5 X14 mm



18-142

18-147

18-152

6 X16 mm



1/2

18-138 - 152  
CASPAR

Length of shaft  
140 mm

Length of shaft  
160 mm

Length of shaft  
185 mm

size of jaws

18-153

18-156

18-159

3 X12 mm



18-154

18-157

18-160

4 X14 mm



18-155

18-158

18-161



5 X14 mm





1/2

18-153 - 161  
CASPAR

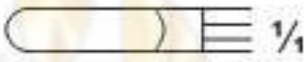

# Rongeurs

Length of shaft 140 mm	Length of shaft 160 mm	Length of shaft 185 mm	size of jaws		
<b>18-162</b>	<b>18-164</b>	<b>185-166</b>	3 X 12 mm		$\frac{1}{4}$
<b>18-163</b>	<b>18-165</b>	<b>18-167</b>	4 X 14 mm		$\frac{1}{4}$



  

<b>18-168</b> 2 X 10 mm GUSHING		$\frac{1}{4}$
<b>18-169</b> 3 X 10 mm LOVE-GRUENWALD		$\frac{1}{4}$
<b>18-170</b> 4 X 10 mm SPURLING		$\frac{1}{4}$

<b>18-171</b> 3 X 10 mm LOVE-GRUENWALD		$\frac{1}{4}$
<b>18-172</b> 4 X 10 mm SPURLING		$\frac{1}{4}$

<b>18-162 - 167</b> GUSHING		$\frac{1}{2}$
<b>18-168 - 170</b> LOVE-GRUENWALD		$\frac{1}{2}$
<b>18-171 - 172</b> LOVE-GRUENWALD		$\frac{1}{2}$

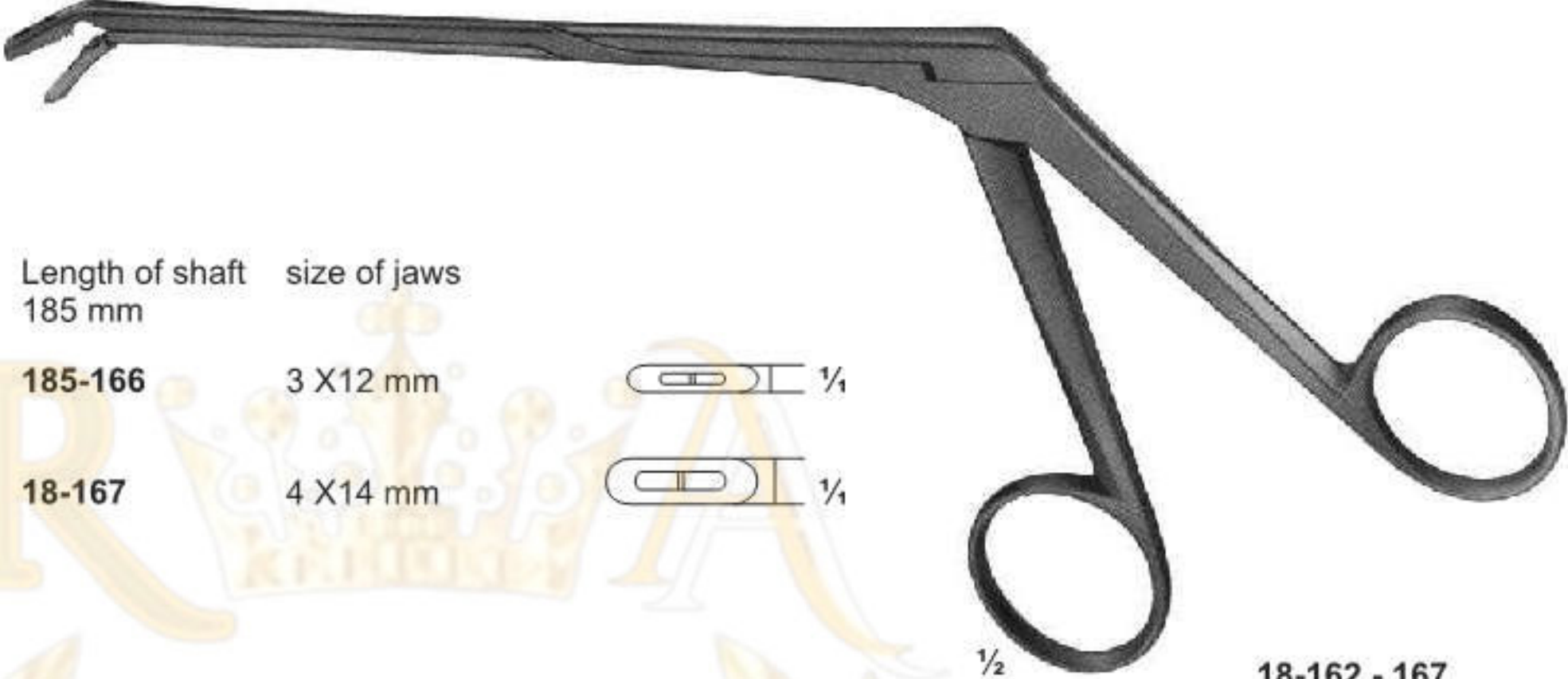
# Rongeurs

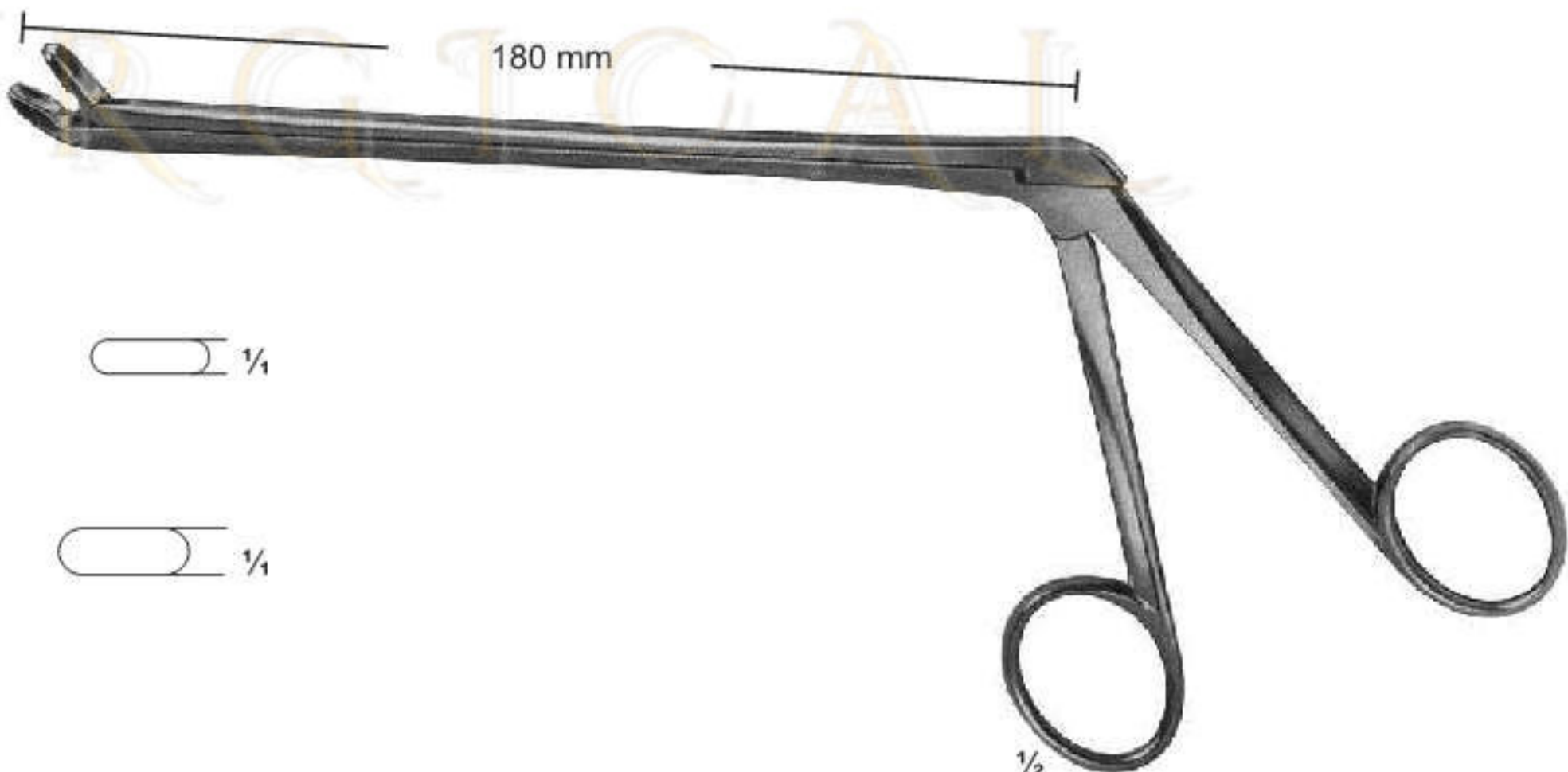
**18-173**  
3 X 10 mm  
LOVE-GRUENWALD



**18-174**  
4 X 10 mm  
SPURLING



**18-173 - 174**  
LOVE-GRUENWALD

**18-175**  
7 mm



**18-175**  
OLDBERG

**18-176**  
YASARGIL  
2,2 mm

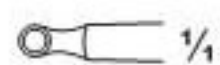

**18-177**  
YASARGIL  
3,5 mm

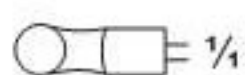

**18-176 - 177**

# Rongeurs

145 mm

18-178  
4 mm

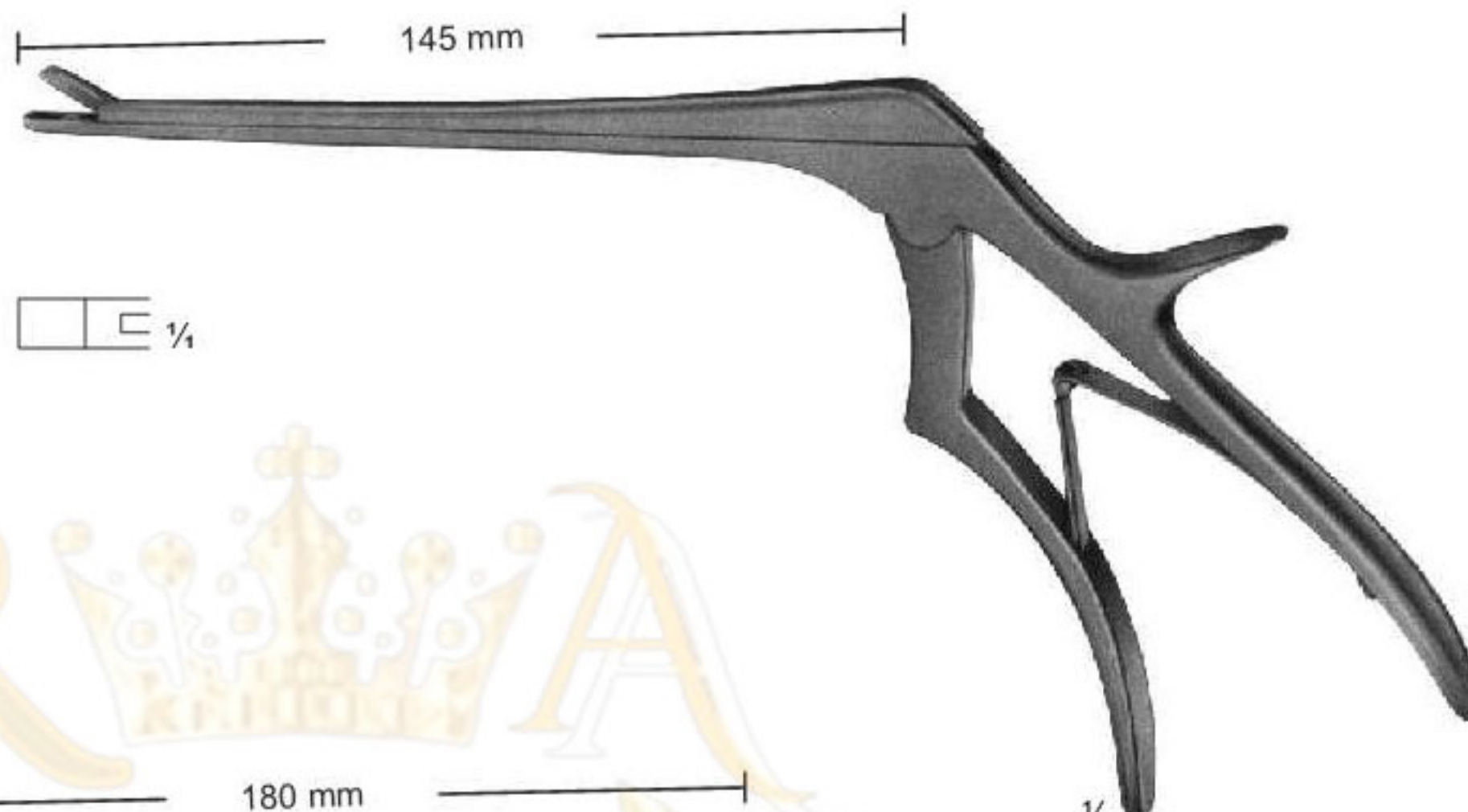
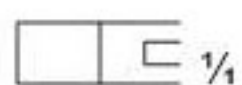

180 mm

18-179  
4 mm

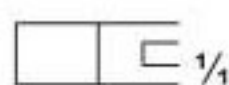

200 mm

18-180  
5,5 mm

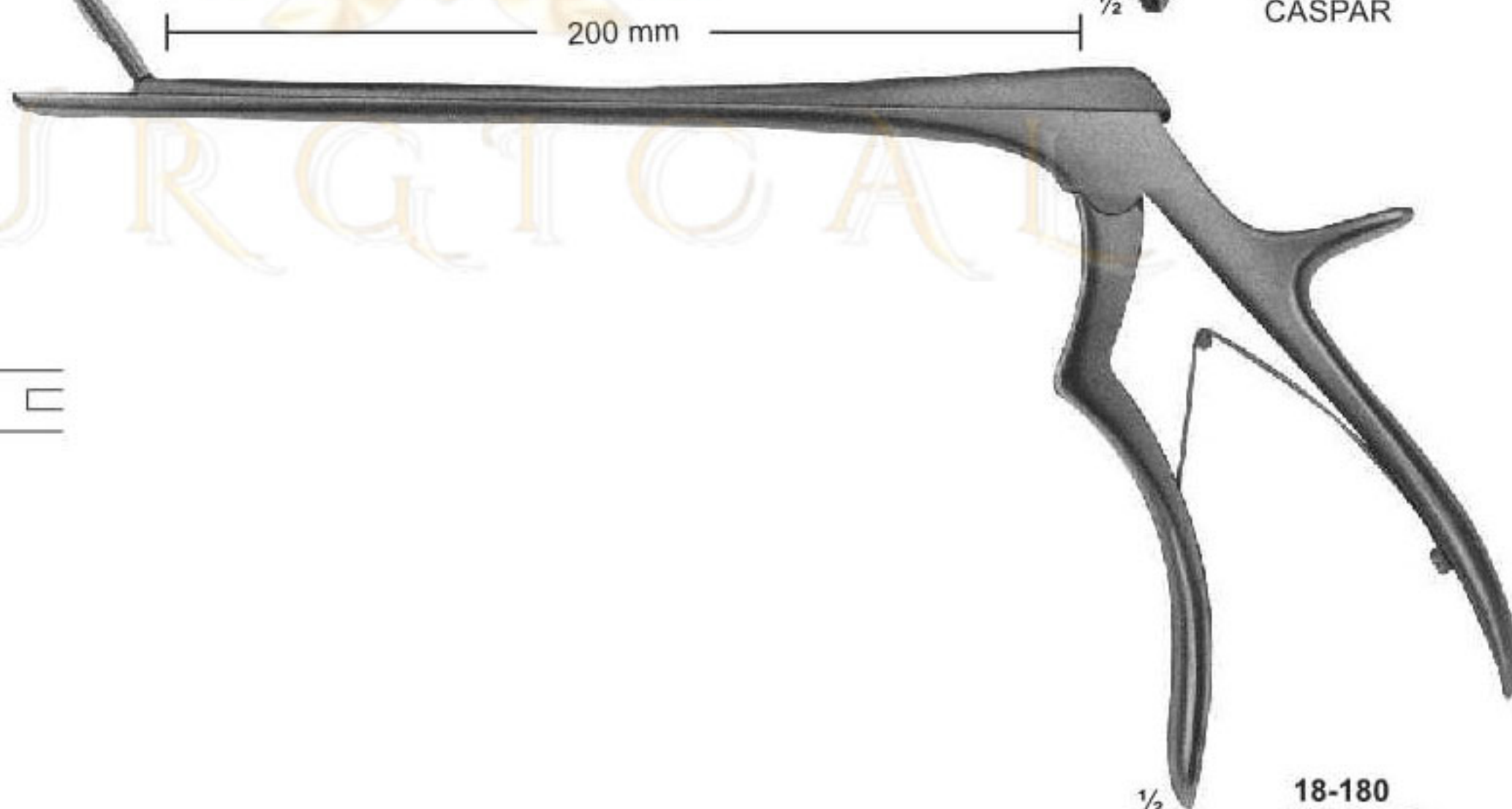

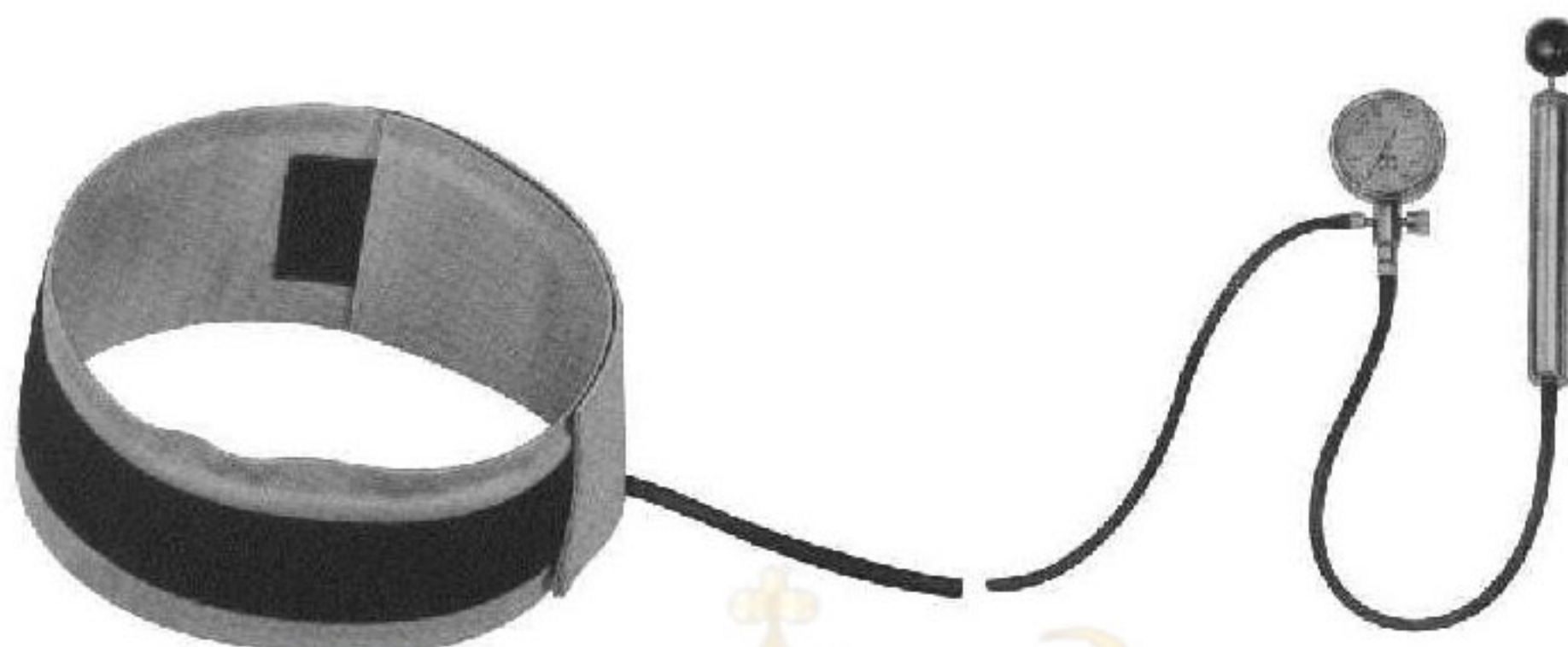

**19-101**  
Comprimeter. Compression apparatus for producing exsanguination in the extremities. Manometer registers up to 600 mm Hg. Complete, consisting of:  
19-101 2 Pump with manometer  
19-102 3 Cuff for the leg  
19-103 14 Cuff for the upper arm

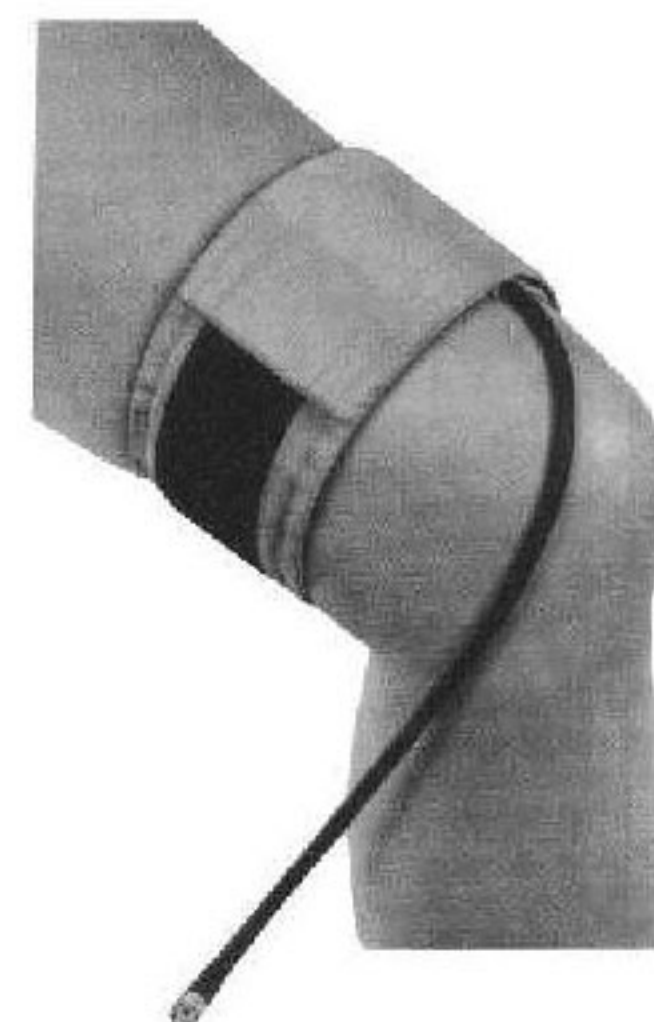

19-104 3 Cuff for the leg  
19-105 4 Cuff for the lower arm  
19-106 5 Cuff for children  
19-107 14 Cuff for the upper arm



**19-108**  
ESMARCH  
Staubinde  
Compression bandage  
5 m lang/long  
6 cm breit/wide



**19-109**  
ESMARCH  
Stauschlauch  
Compression tube  
1 m lang/long

# Amputation and Resection Knives



**19-110**  
Length of blades  
Phalangeal knife  
105 mm



**19-111**  
Length of blades  
Interosseous knife  
110 mm



**19-112**  
Length of blades  
Periosteum knife  
with raspator  
65 mm



**19-113 - 114**  
LANGENBECK  
Length of blades  
Resection knives  
55 mm



**19-113**

**19-114**

# Amputation Retractors

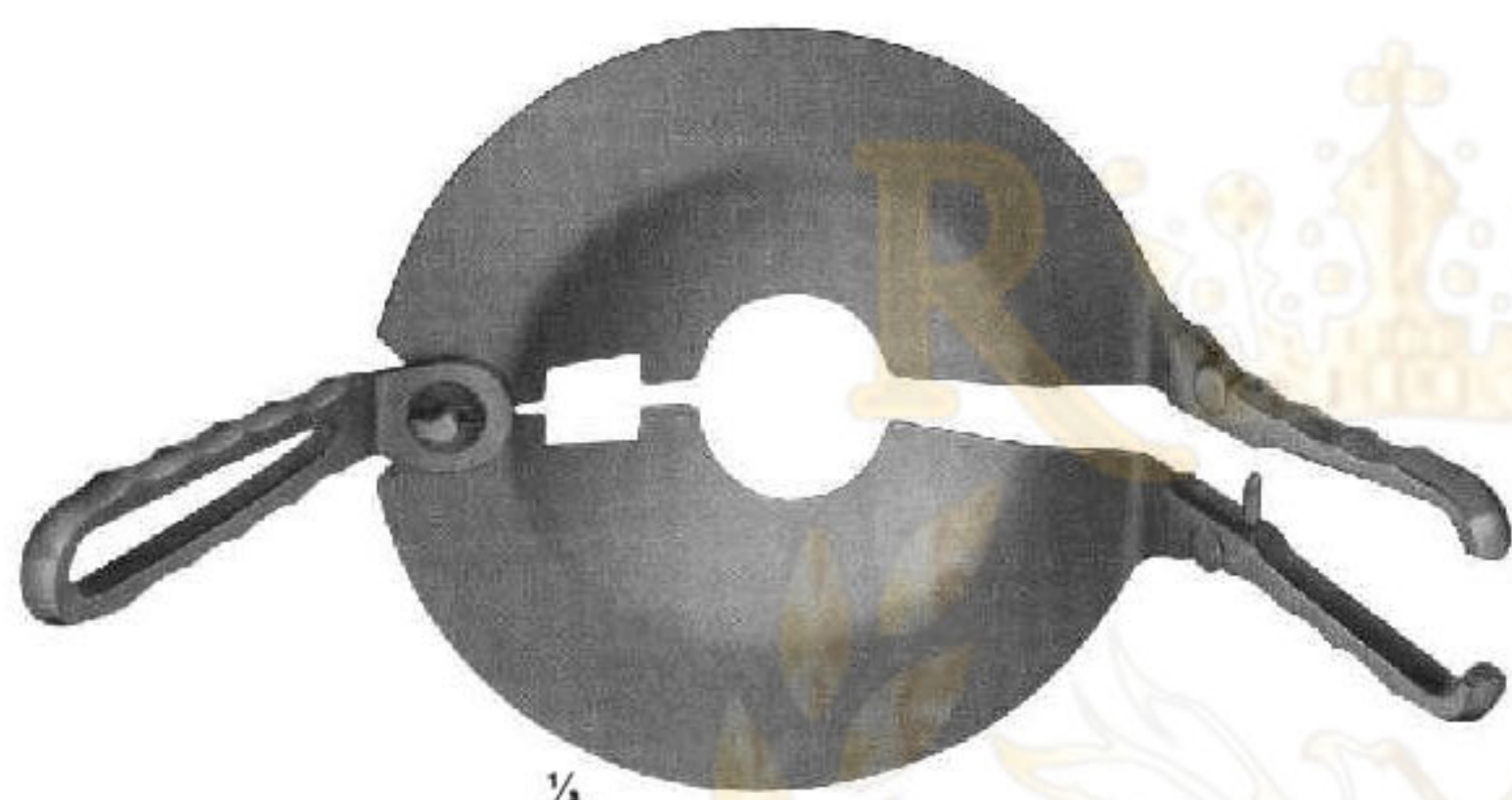

**19-115**  
PERCY  
removeable handles

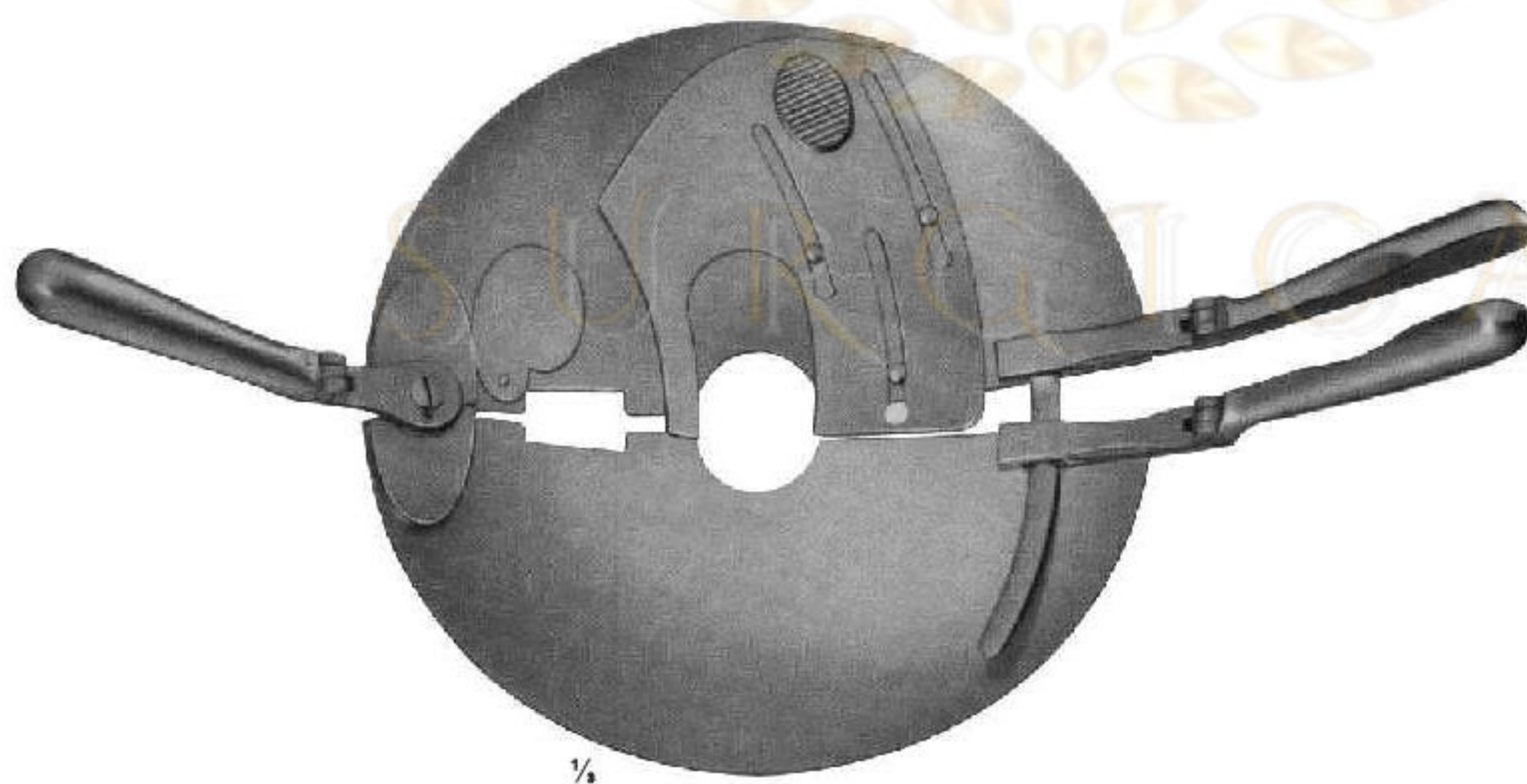

**19-116**  
PERCY  
reversible handles



# Amputation Saws

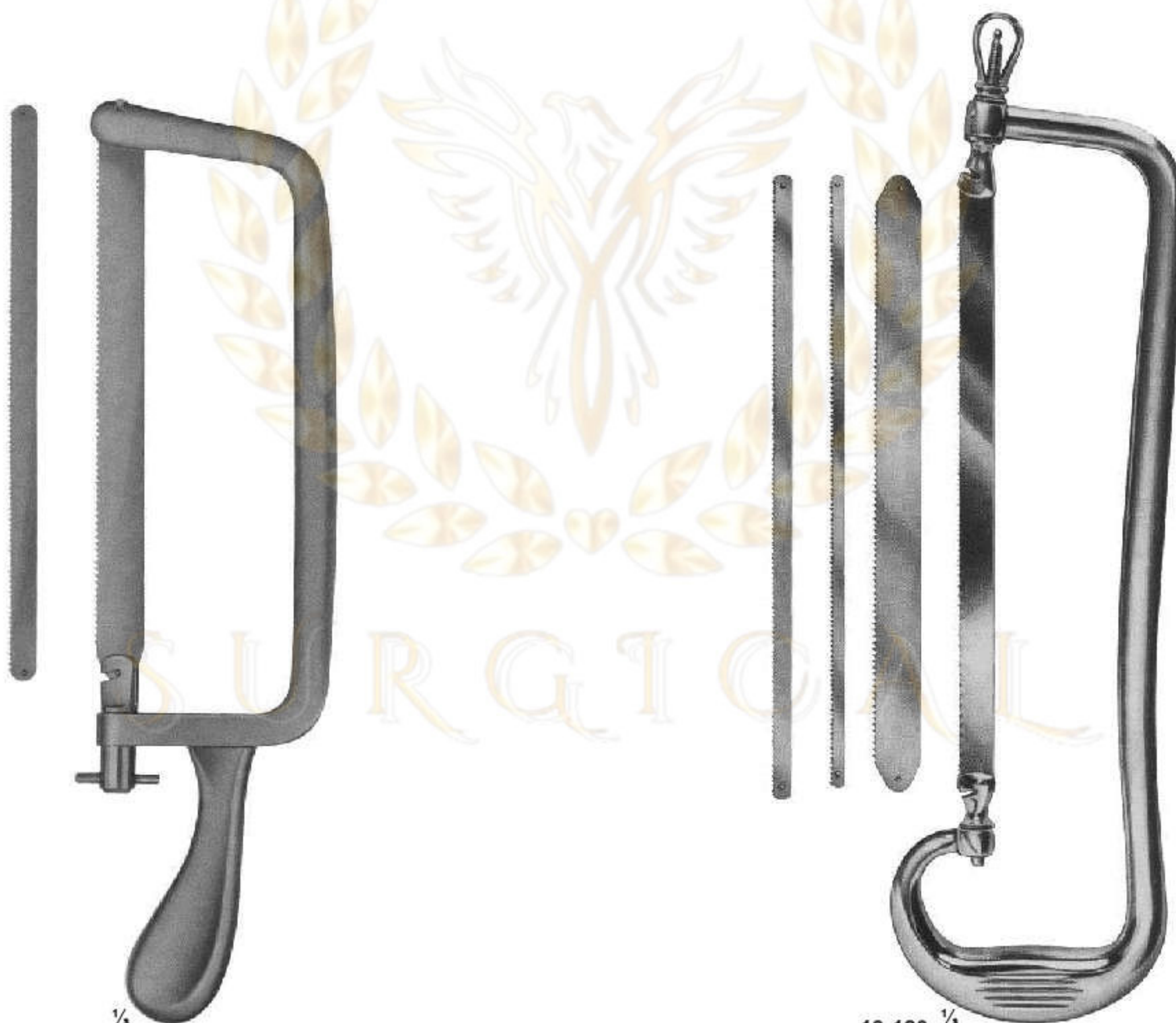

19-117  
CHARRIÈRE  
Length of blade  
215 mm  
complete with one saw  
blade each  
350 mm  
Spare saw blades, carbon steel  
19-118 12 mm  
19-119 20 mm

19-120 1/2  
RUST  
Length of blade  
235 mm  
complete with one saw  
blade each  
390 mm  
19-121 Bow only  
Spare saw blades, carbon steel  
19-122 6 mm  
19-123 8 mm  
19-124 12 mm  
19-125 20 mm

# Amputation Saws



1/2

**19-126**  
BIER  
Length of blade  
270 mm  
complete with one saw  
blade each  
420 mm  
Spare saw blades, carbon steel  
**19-127** 4 mm  
**19-128** 6 mm  
**19-129** 8 mm



1/2

**19-130**  
CHARRIERE  
Length of blade  
180 mm  
Spare saw blades,  
carbon steel  
270 mm

**19-131**  
CHARRIERE  
Length of blade  
240 mm  
Spare saw blades,  
carbon steel  
340 mm



1/2

**19-132**  
SATTERLEE  
Length of blade  
200 mm  
Spare saw blades,  
carbon steel  
290 mm



1/2

**19-133**  
LANGENBACK  
Length of blade  
115 mm  
Metacarpal saw  
235 mm

# Wire Saws and Conductor



**OLIVECRONA**  
**19-134** 300 mm  
**19-135** 400 mm  
**19-136** 500 mm  
**19-137** 700 mm



**GIGLI**  
**19-138** 300 mm  
**19-139** 400 mm  
**19-140** 500 mm  
 fine, 6 wires twisted  
**19-141**  
 coares, 4 wires twisted



$\frac{1}{4}$   
**19-142**  
**GIGLI**  
 Handle



$\frac{1}{2}$   
**19-143**  
**LEBSCHE**  
 Conductor for  
 wire saws, malleable  
 250 mm

# Elevators and Bone Levers



# Bone Levers

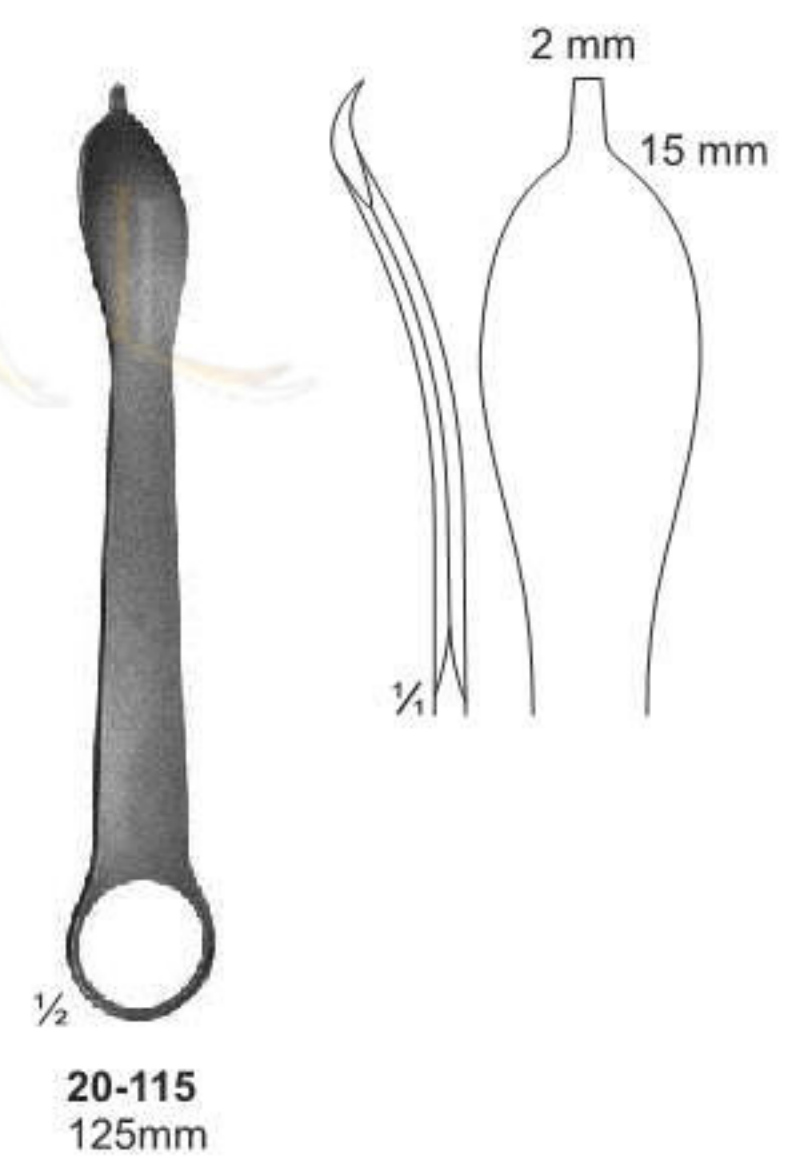
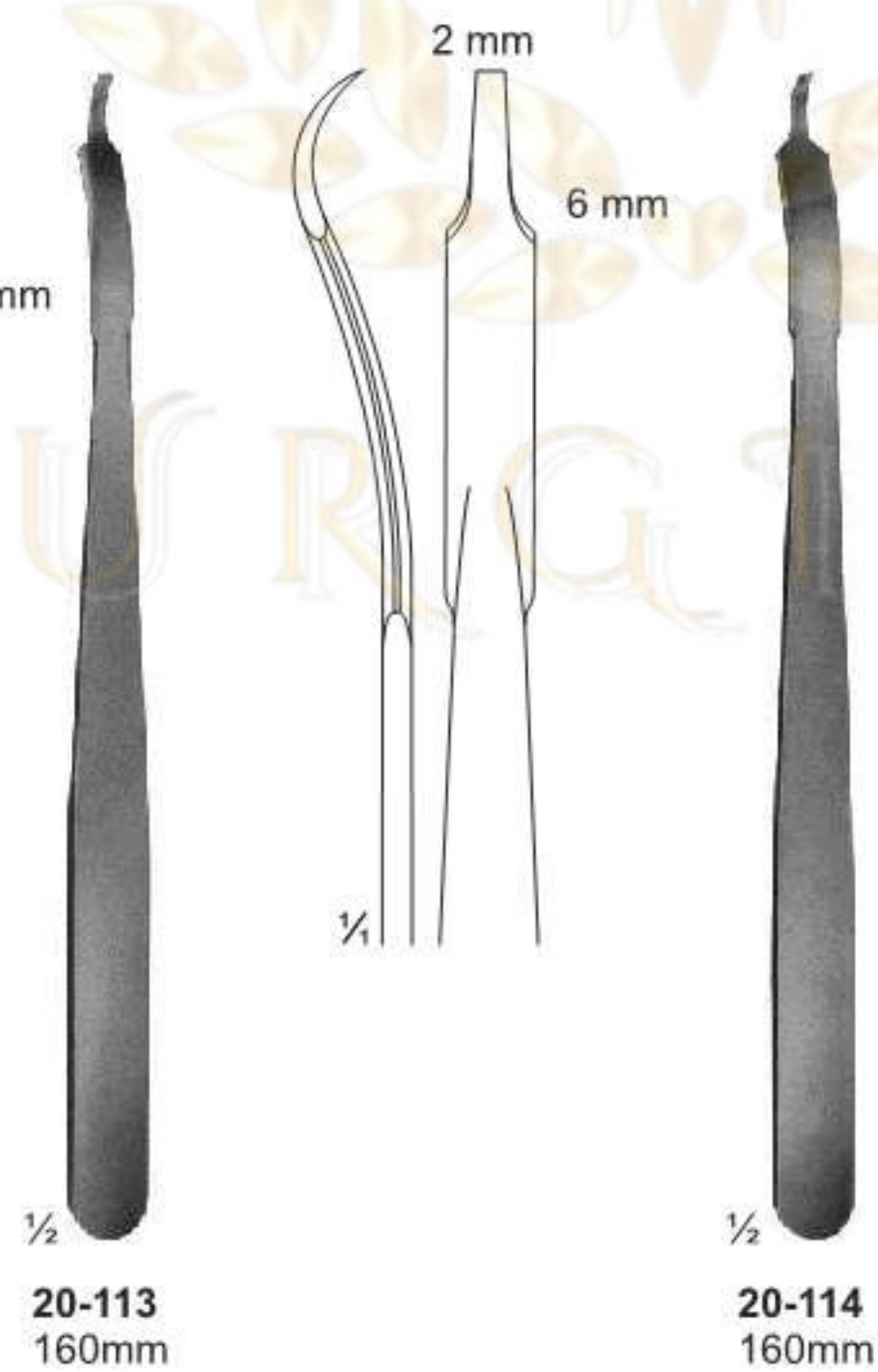
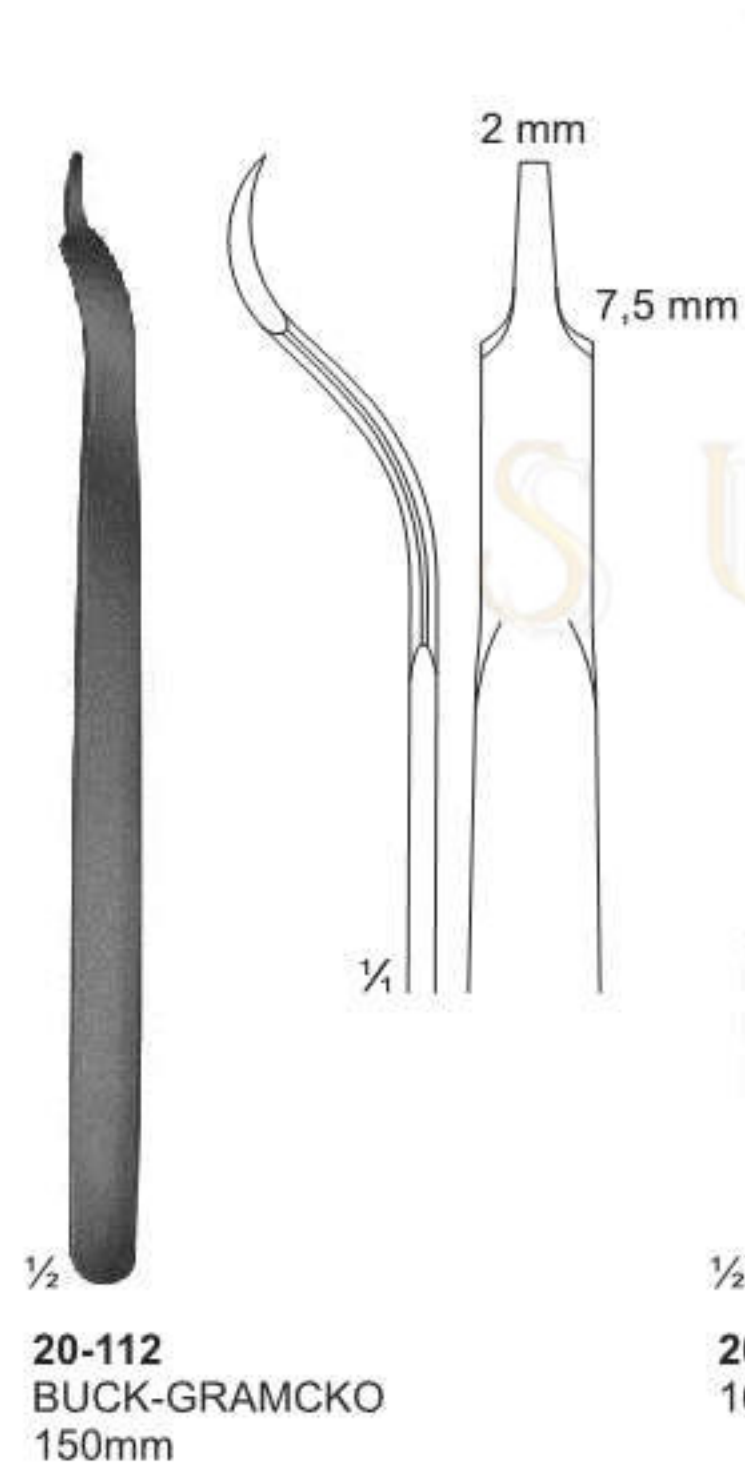
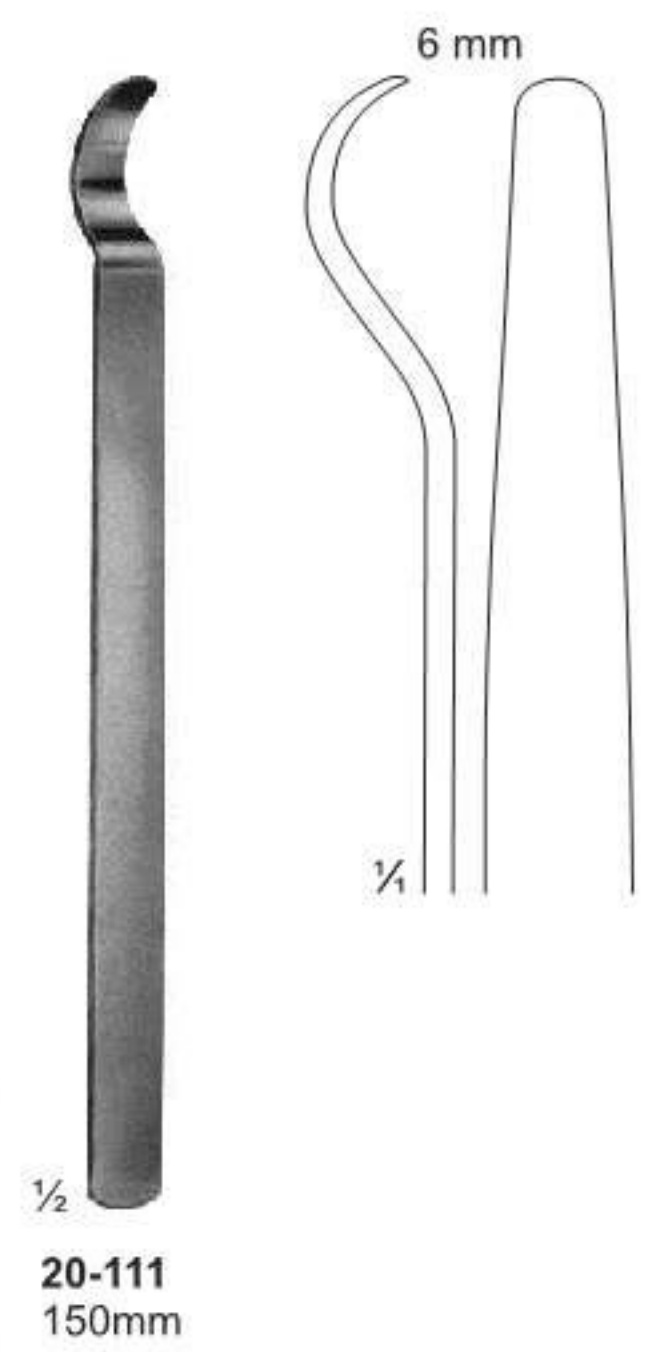
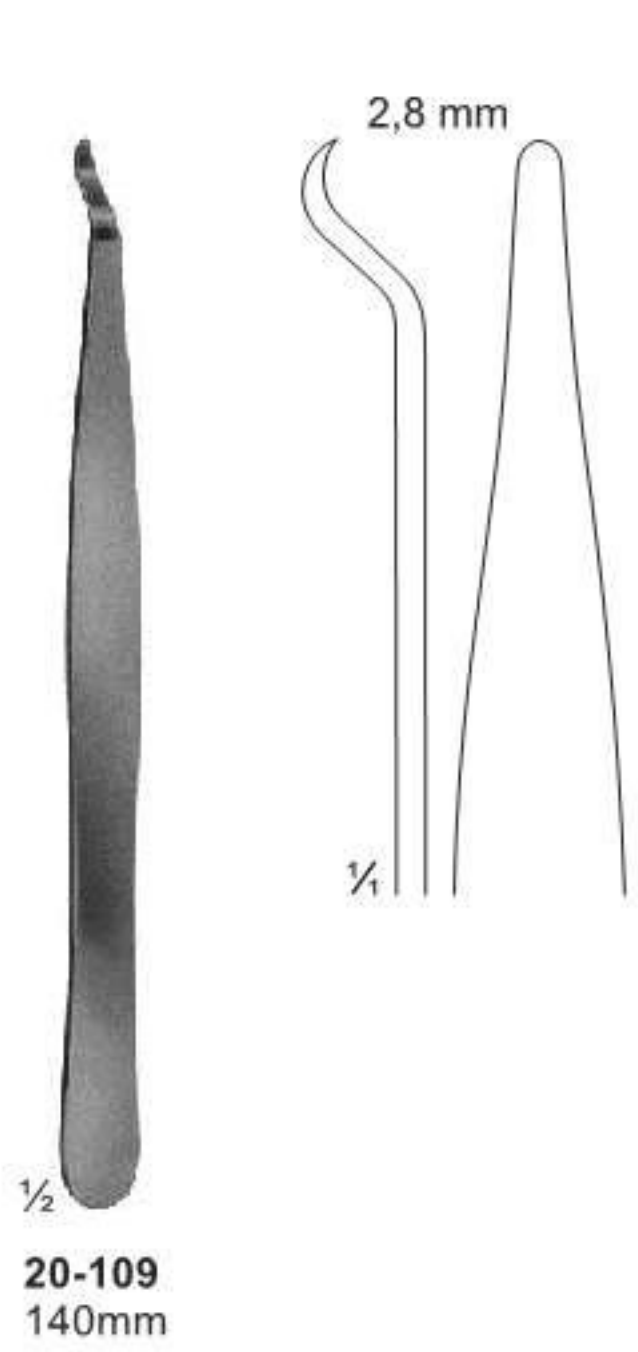

# Bone Levers



**20-116**  
LANE TRETOWAN  
215mm

**20-117**  
LANE  
255mm

**20-118**  
LANGE-HOHMANN  
250mm

**20-119 - 120**  
LANGE-HOHMANN  
20-119 265mm  
20-120 280mm

# Bone Levers

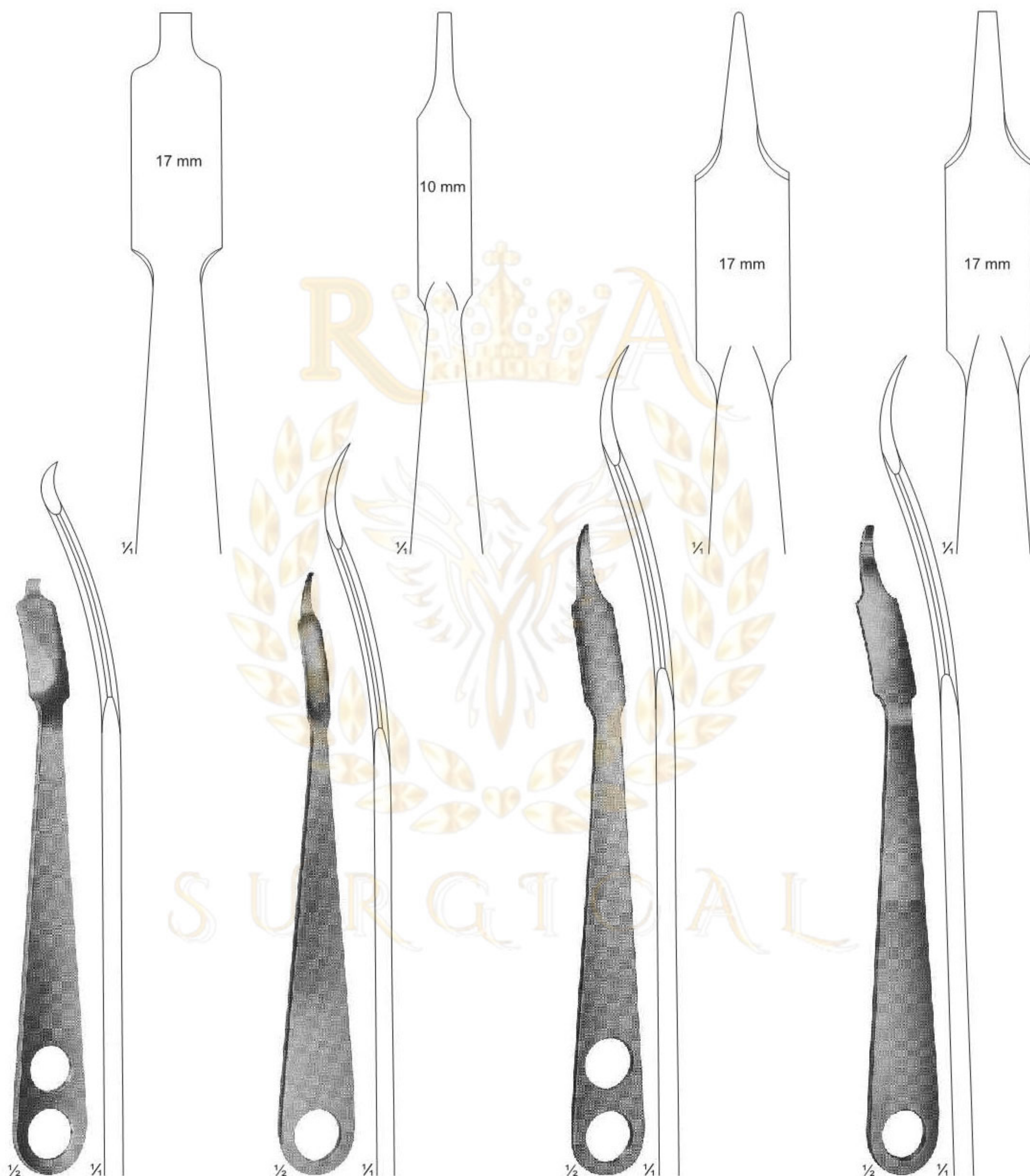

**20-121**  
WAGNER  
220 mm

**20-122**  
220 mm

**20-123**  
240 mm

**20-124**  
240 mm

# Bone Levers

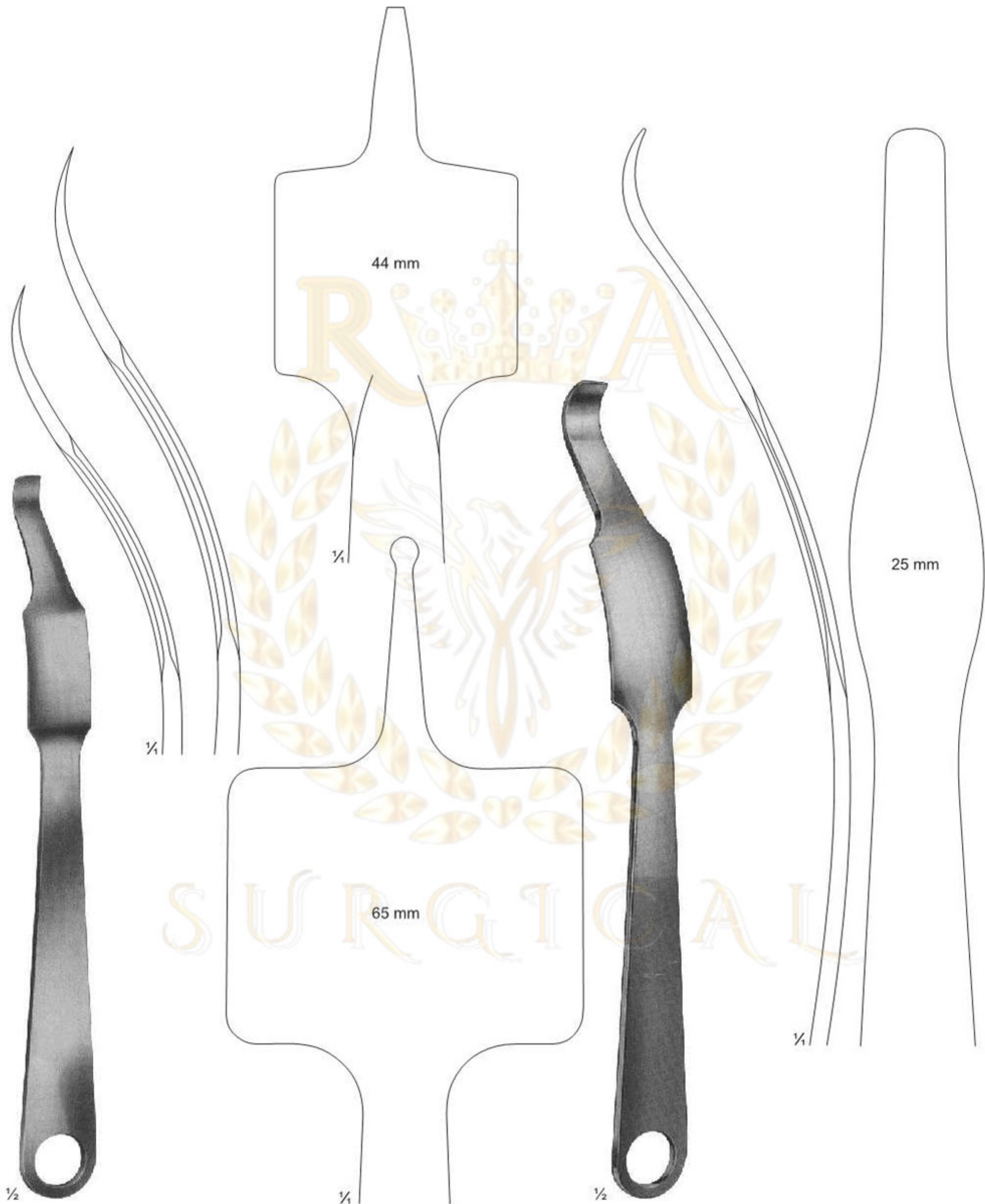

20-125 - 126  
VERBRUGGE-MULLER  
20-125 240 mm  
20-126 255 mm

20-127  
260 mm



# Bone Levers



**20-128**  
HOHMANN-ALDINGER  
270 mm

**20-129**  
SCHUMACHER mod. WAGNER  
345 mm

**20-130**  
SCHUMACHER  
290 mm

# Special Bone Levers

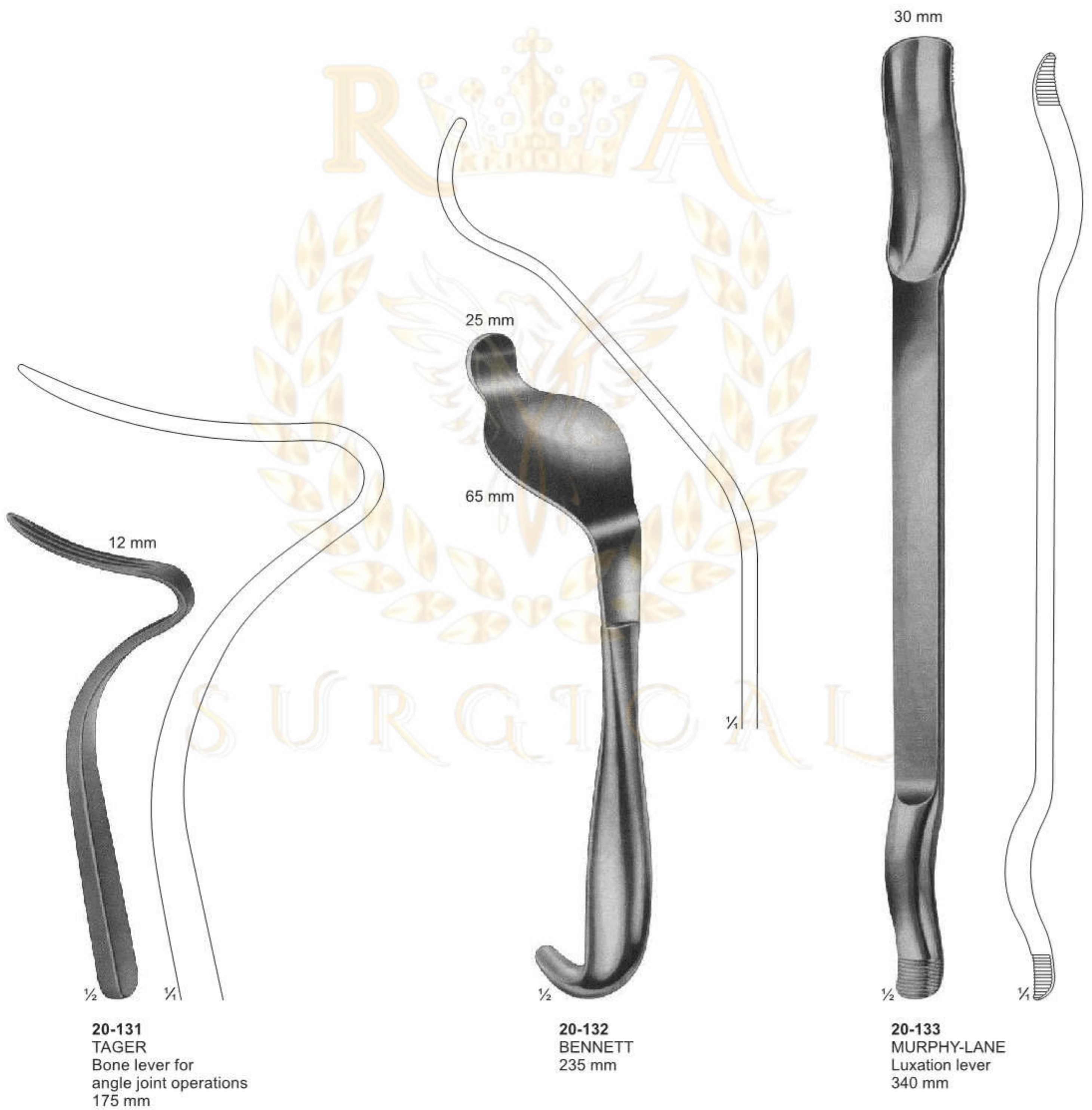

**20-131**  
**TAGER**  
Bone lever for  
angle joint operations  
175 mm

**20-132**  
**BENNETT**  
235 mm

**20-133**  
**MURPHY-LANE**  
Luxation lever  
340 mm

# Raspatories

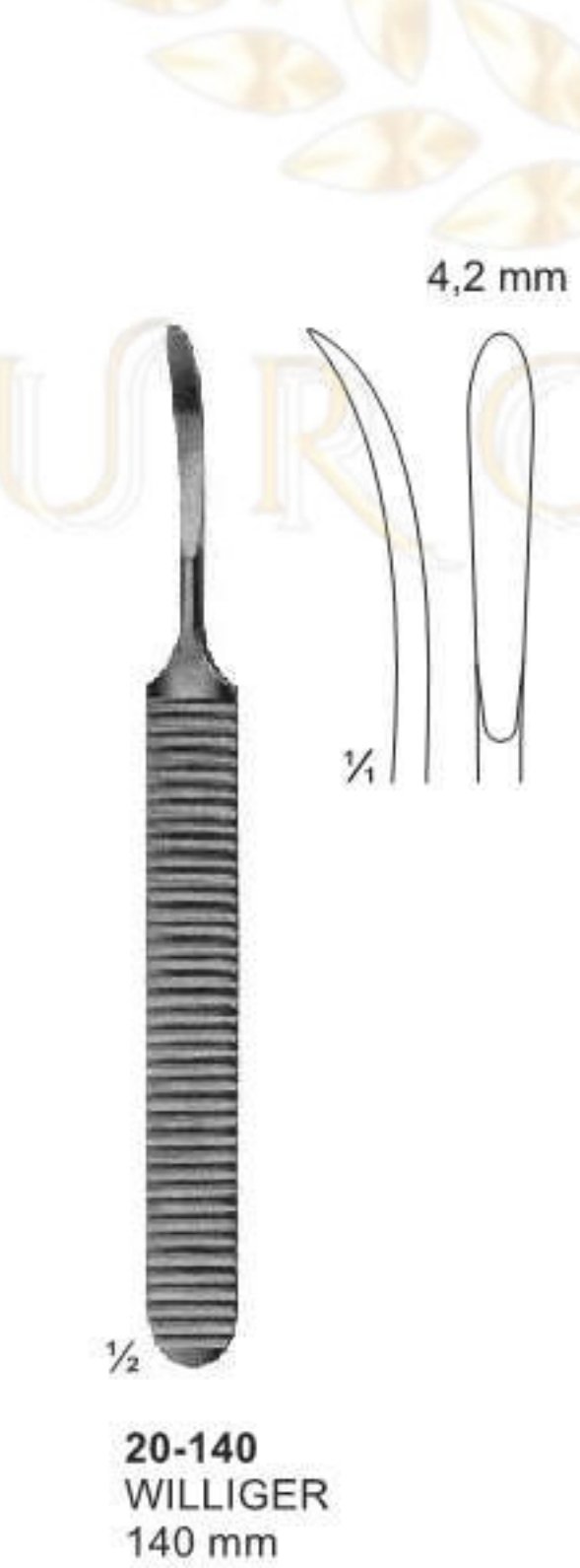
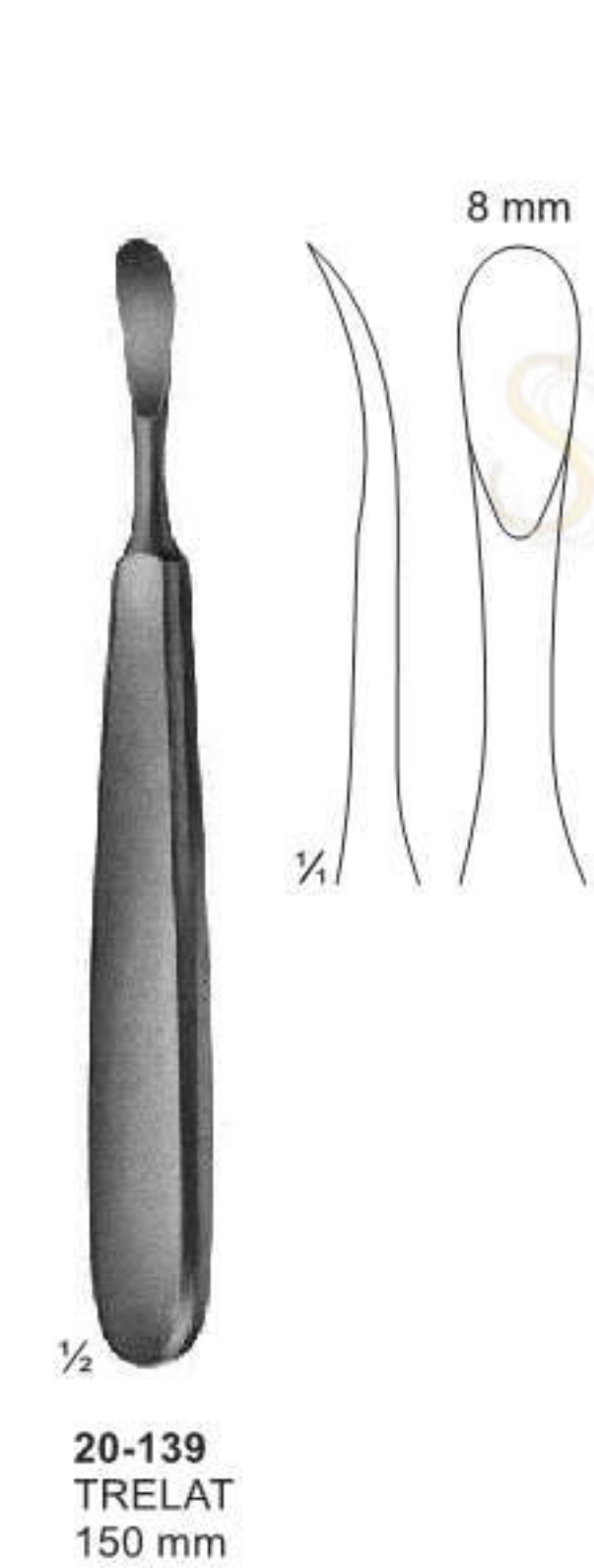
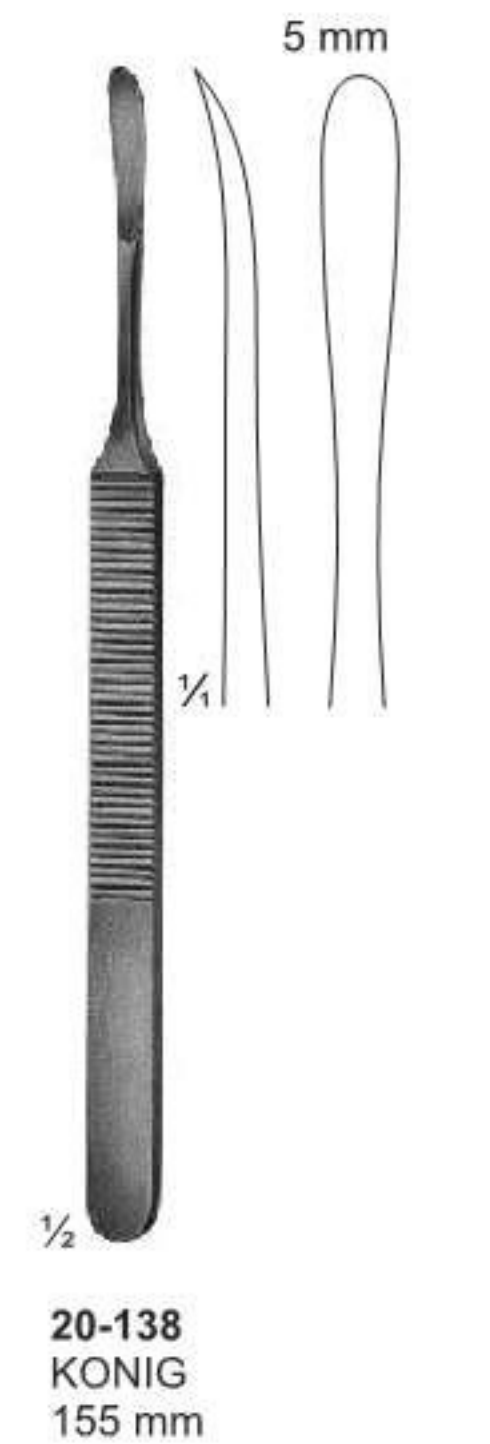
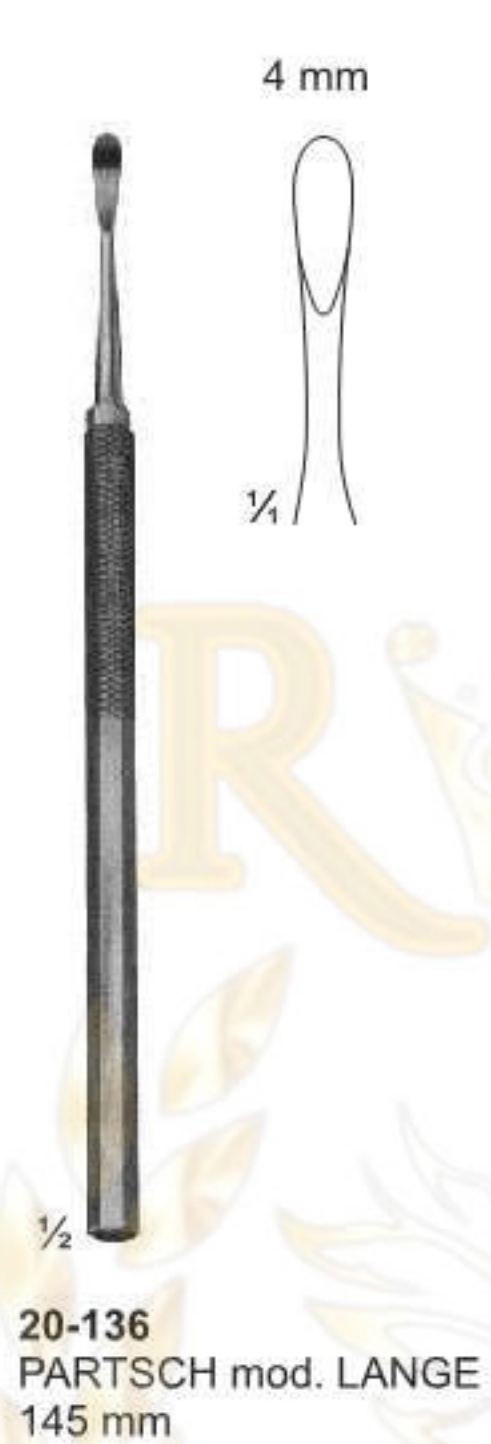
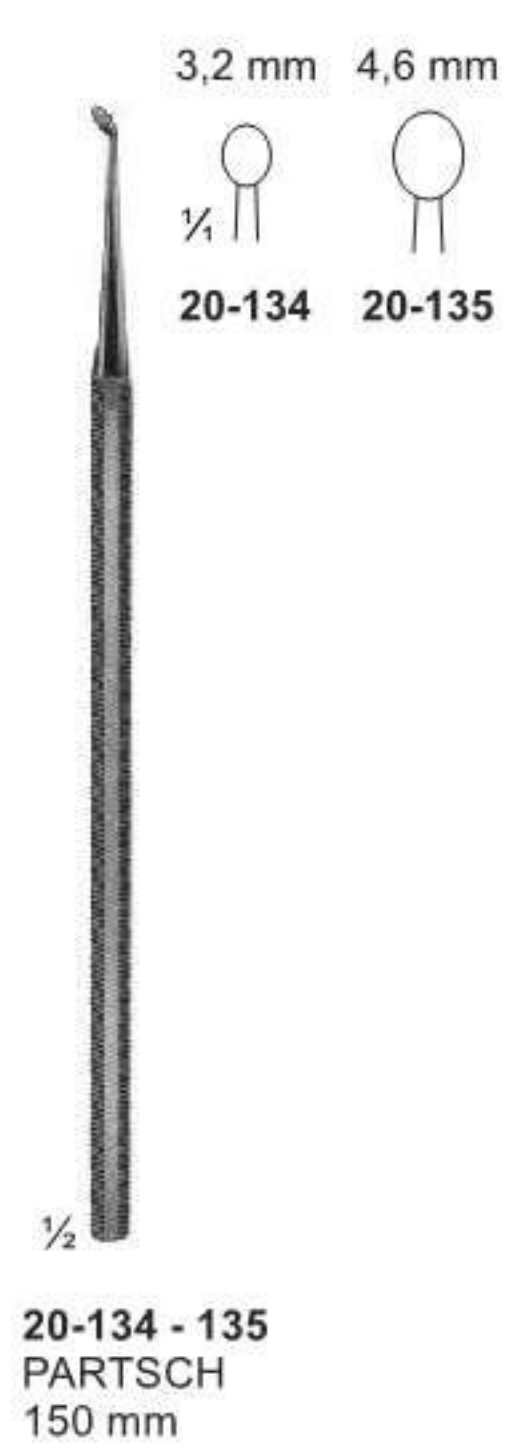

# Raspatories

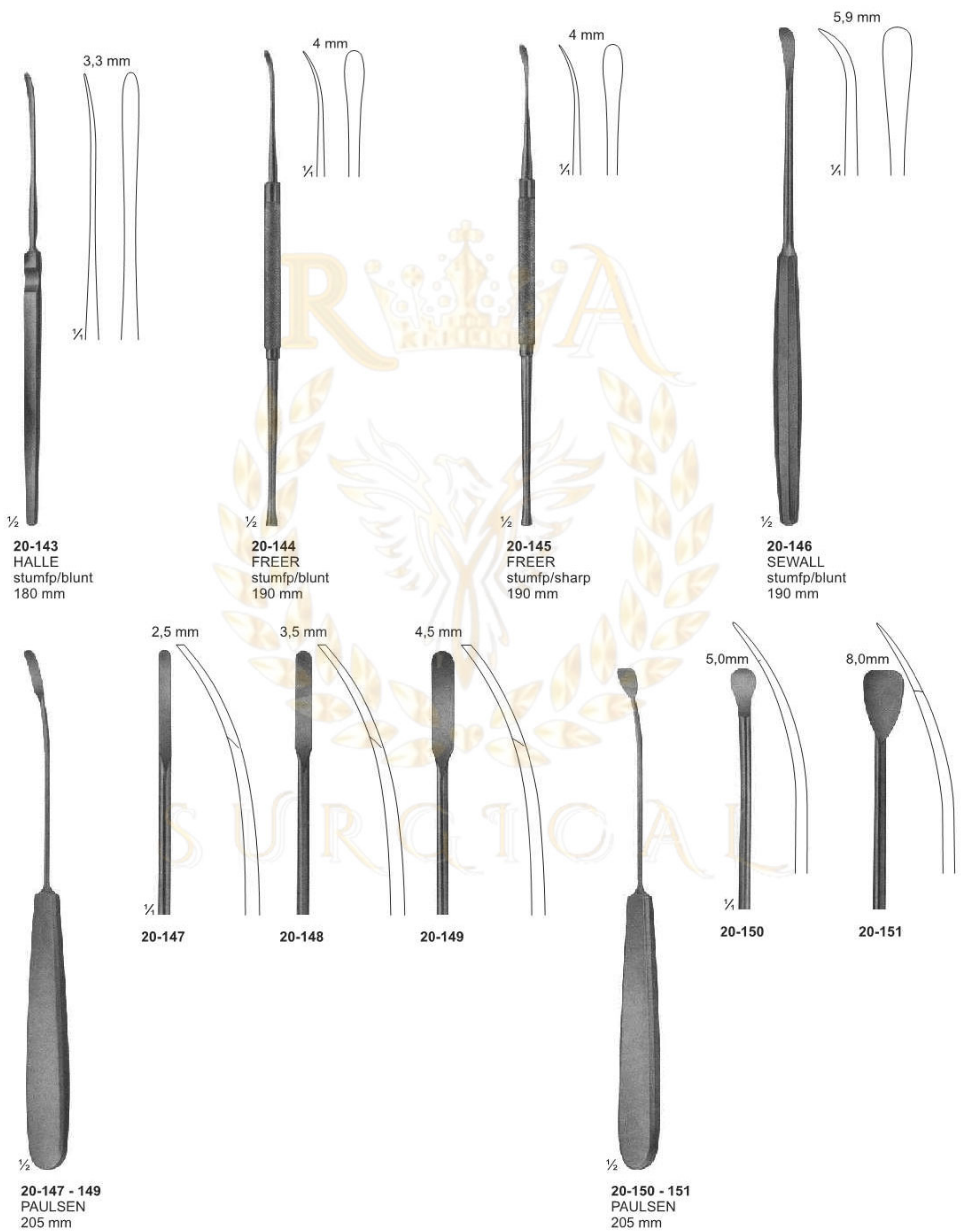

3,3 mm  
 $\frac{1}{2}$   
**20-143**  
 HALLE  
 stumfp/blunt  
 180 mm

4 mm  
 $\frac{1}{2}$   
**20-144**  
 FREER  
 stumfp/blunt  
 190 mm

4 mm  
 $\frac{1}{2}$   
**20-145**  
 FREER  
 stumfp/sharp  
 190 mm

5,9 mm  
 $\frac{1}{2}$   
**20-146**  
 SEWALL  
 stumfp/blunt  
 190 mm

$\frac{1}{2}$   
**20-147 - 149**  
 PAULSEN  
 205 mm

2,5 mm  
 $\frac{1}{4}$   
**20-147**

3,5 mm  
 $\frac{1}{4}$   
**20-148**

4,5 mm  
 $\frac{1}{4}$   
**20-149**

5,0mm  
 $\frac{1}{4}$   
**20-150 - 151**  
 PAULSEN  
 205 mm

8,0mm  
 $\frac{1}{4}$   
**20-150**  
**20-151**

# Raspatories

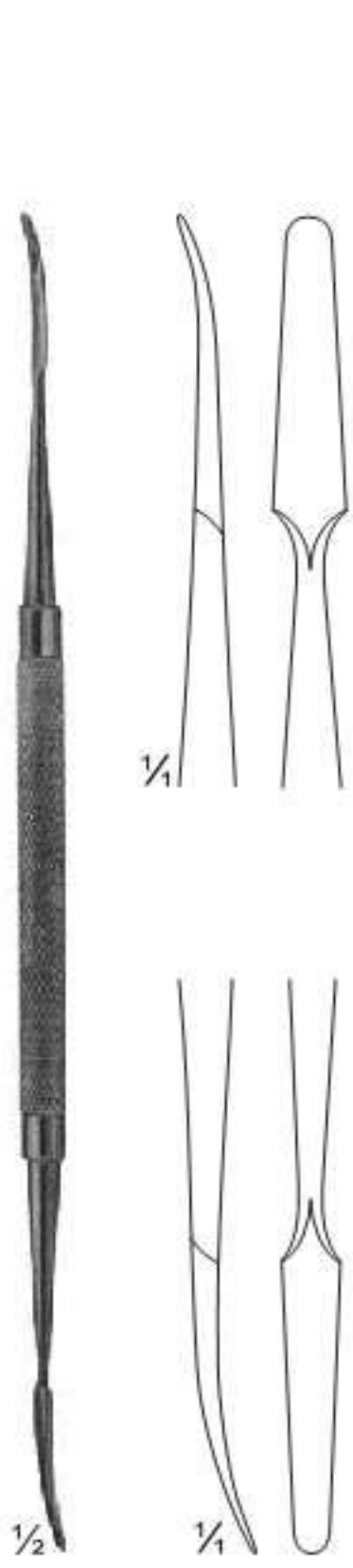

**20-152**  
KILLIAN  
sharp/blunt  
185 mm



**20-153**  
HOWARTH  
sharp/blunt  
215 mm



**20-154**  
KILLIAN  
sharp/blunt  
185 mm

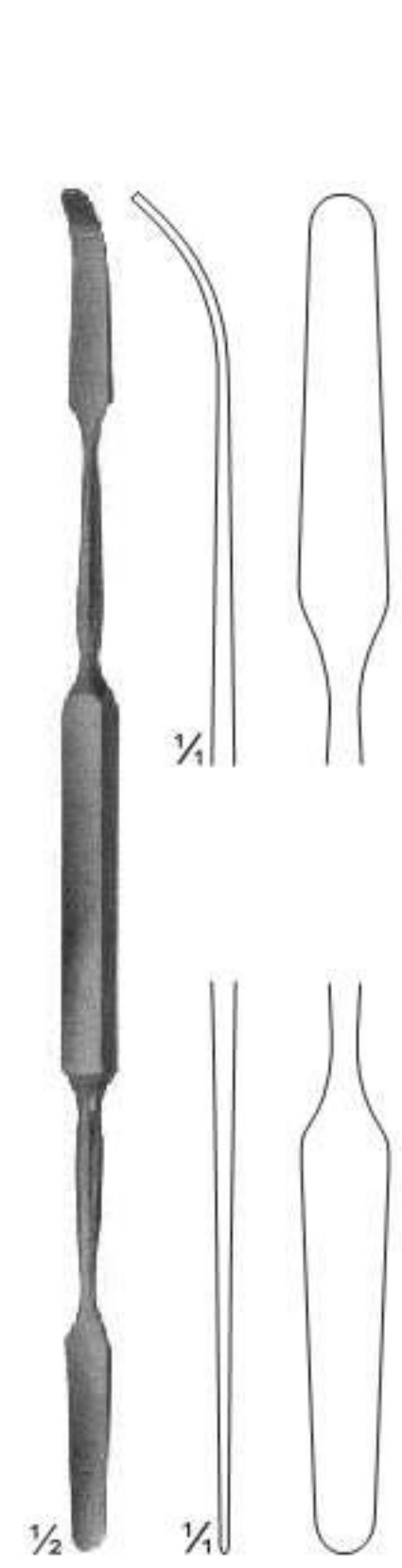

**20-155**  
MAC DONALD  
blunt/blunt  
185 mm

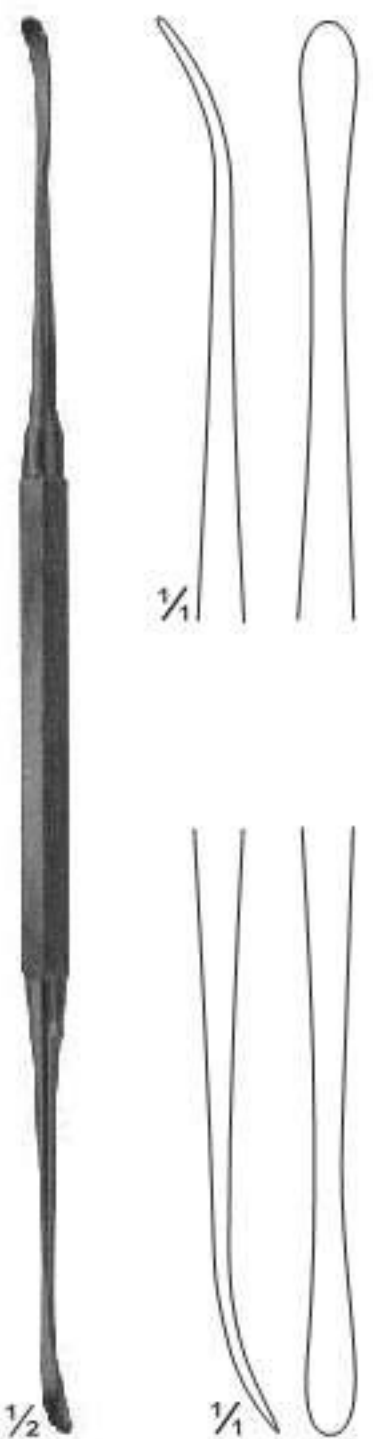

**20-156**  
FREER  
sharp/blunt  
185 mm

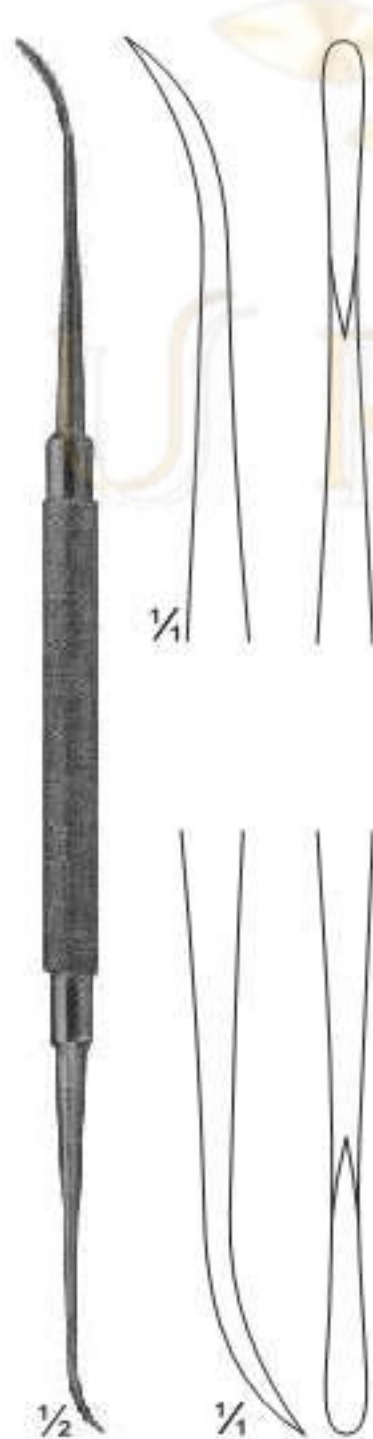

**20-157**  
FREER-YASARGIL  
sharp/sharp  
185 mm

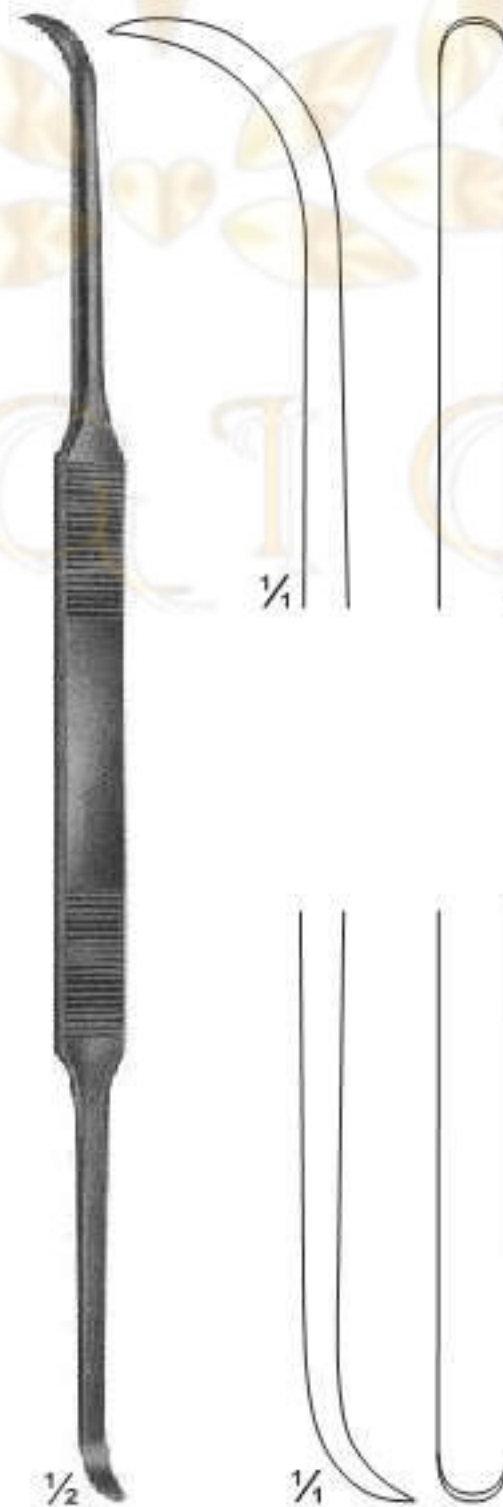

**20-158**  
COTTLE  
sharp/sharp  
200 mm

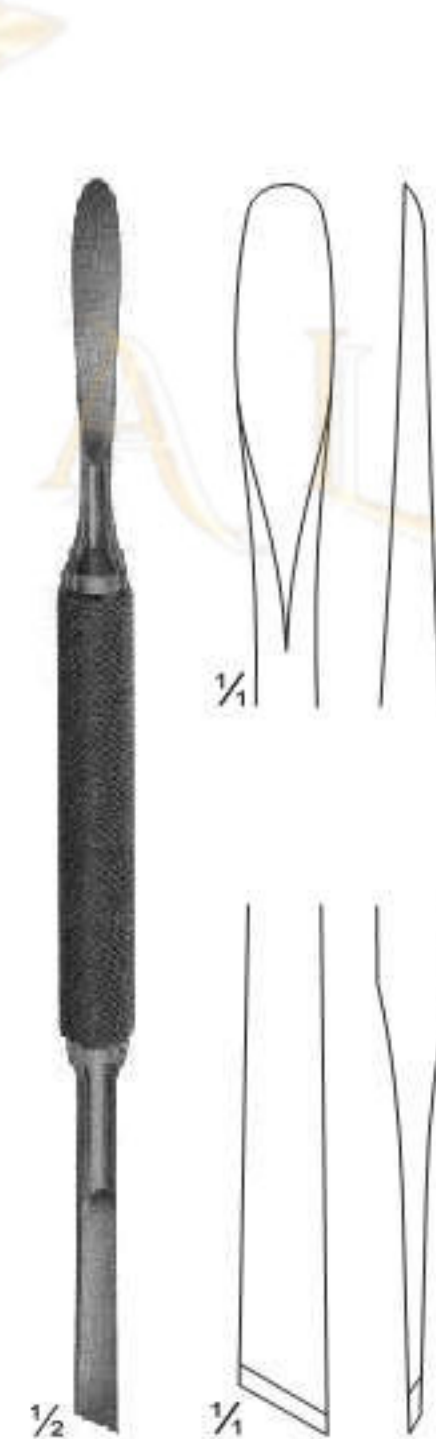

**20-159**  
MEAD  
sharp/sharp  
165 mm

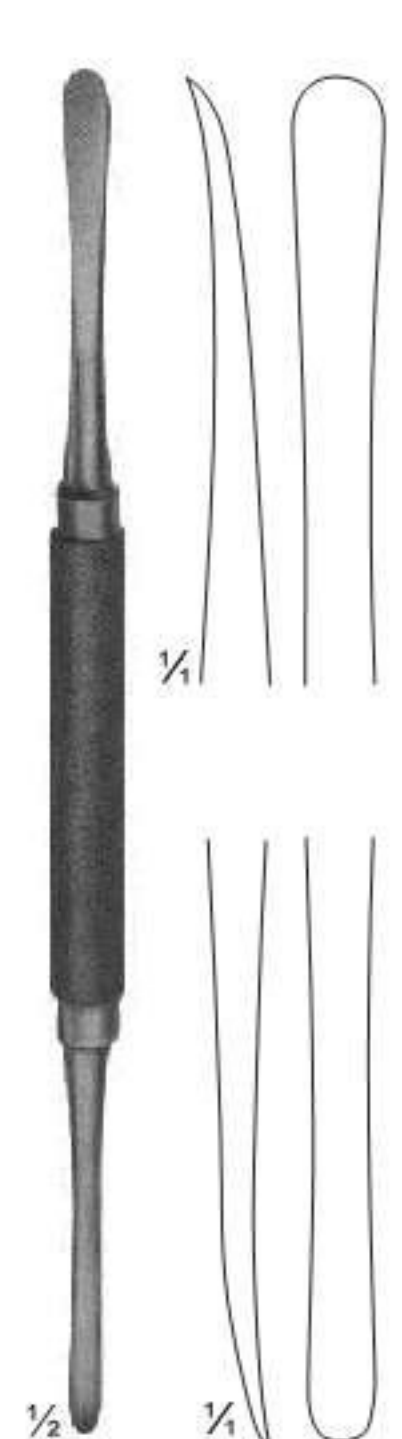

**20-160**  
MOLT  
sharp/sharp  
180 mm

# Raspatories

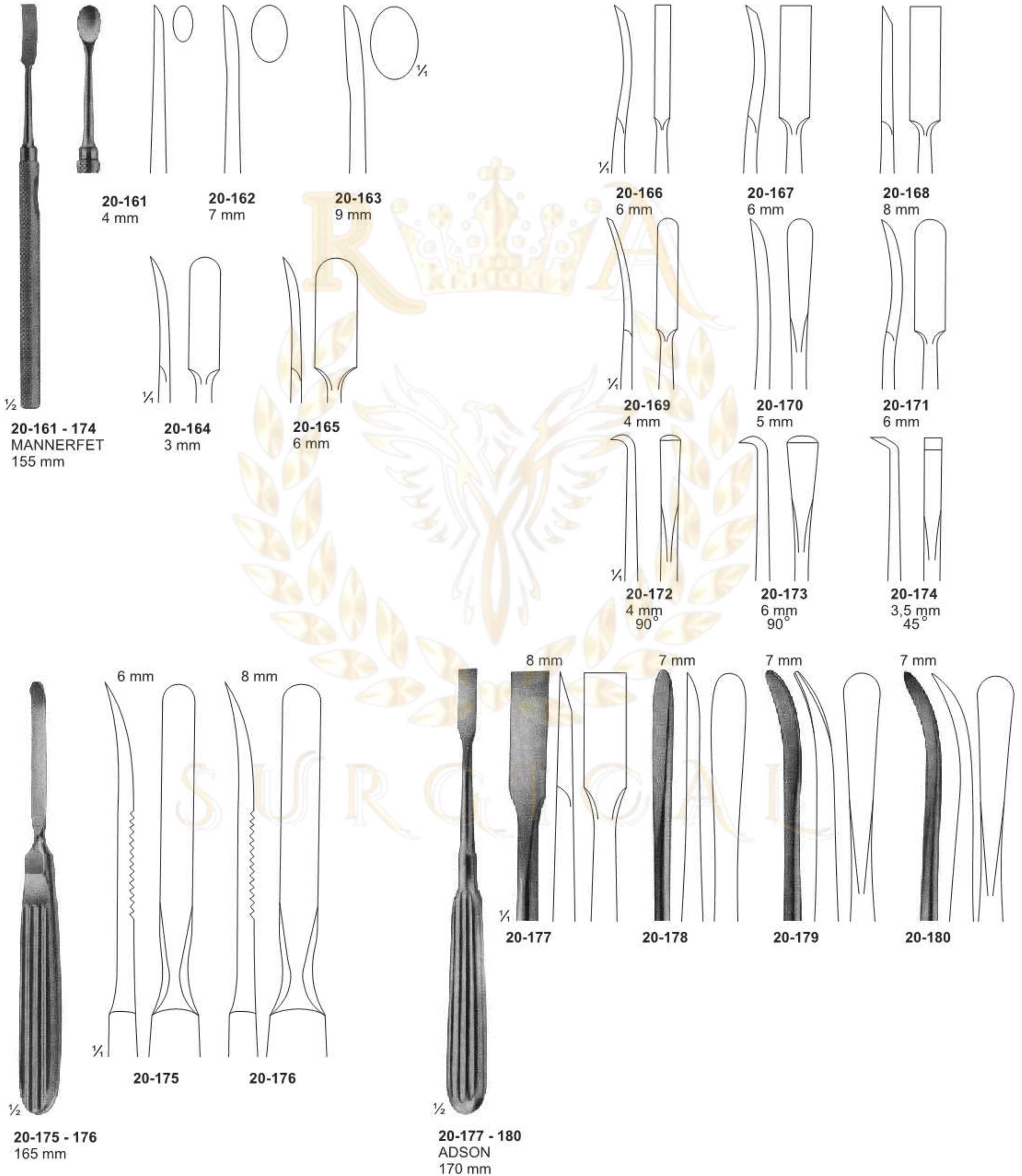

# Raspatories

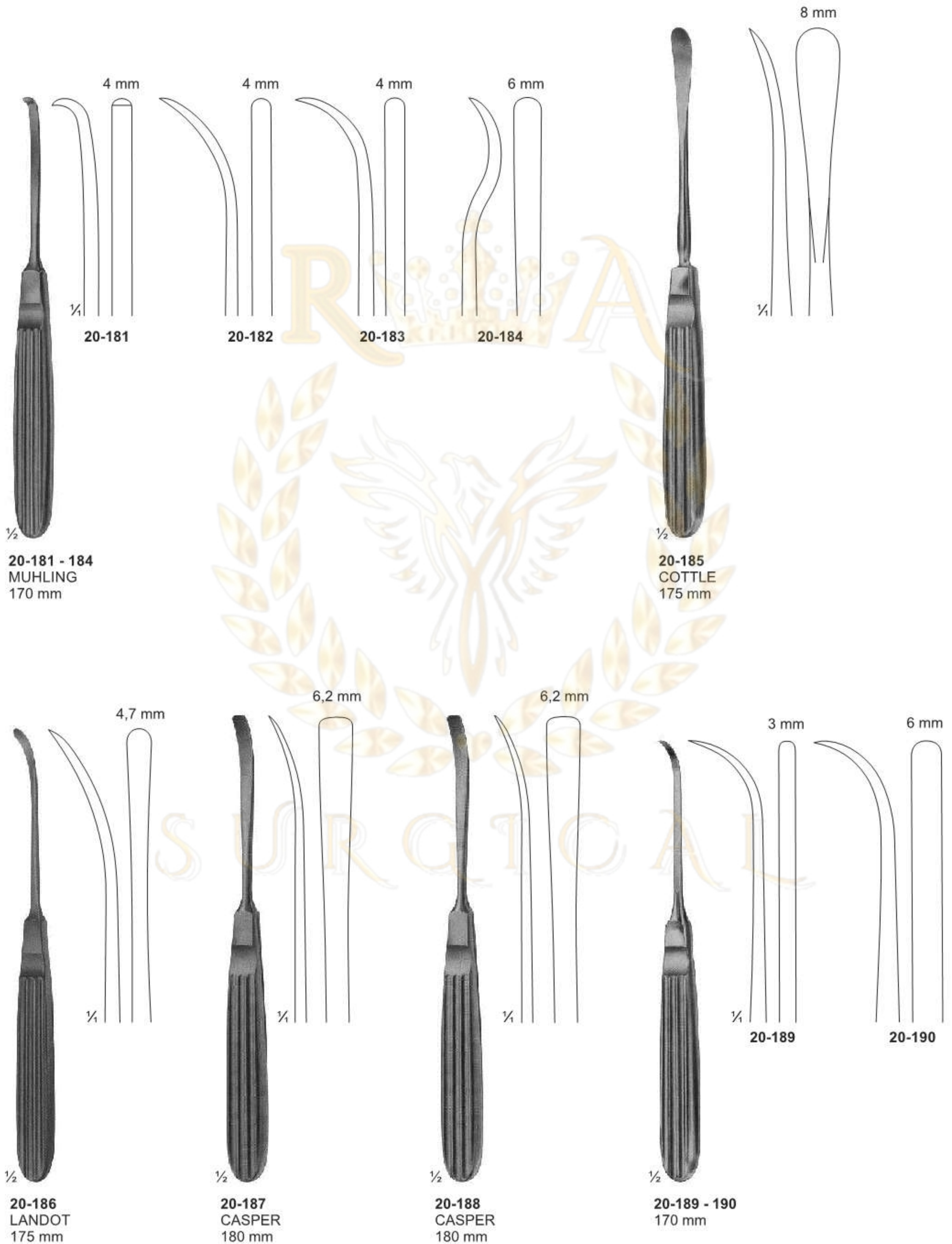

# Raspatories

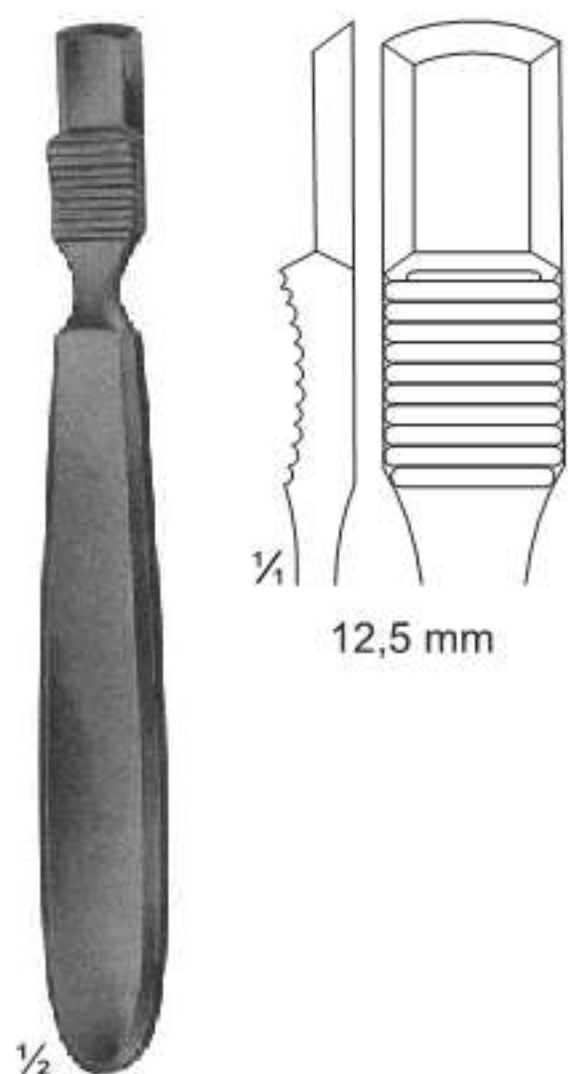

**20-191**  
FARABEUF  
140 mm

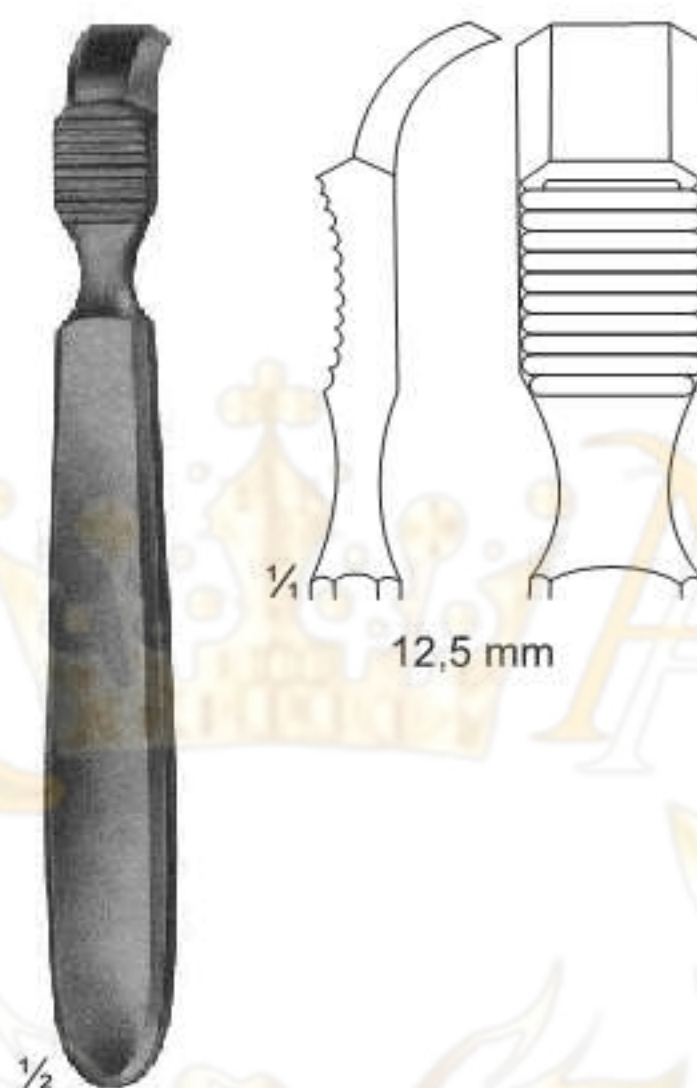

**20-192**  
FARABEUF  
140 mm

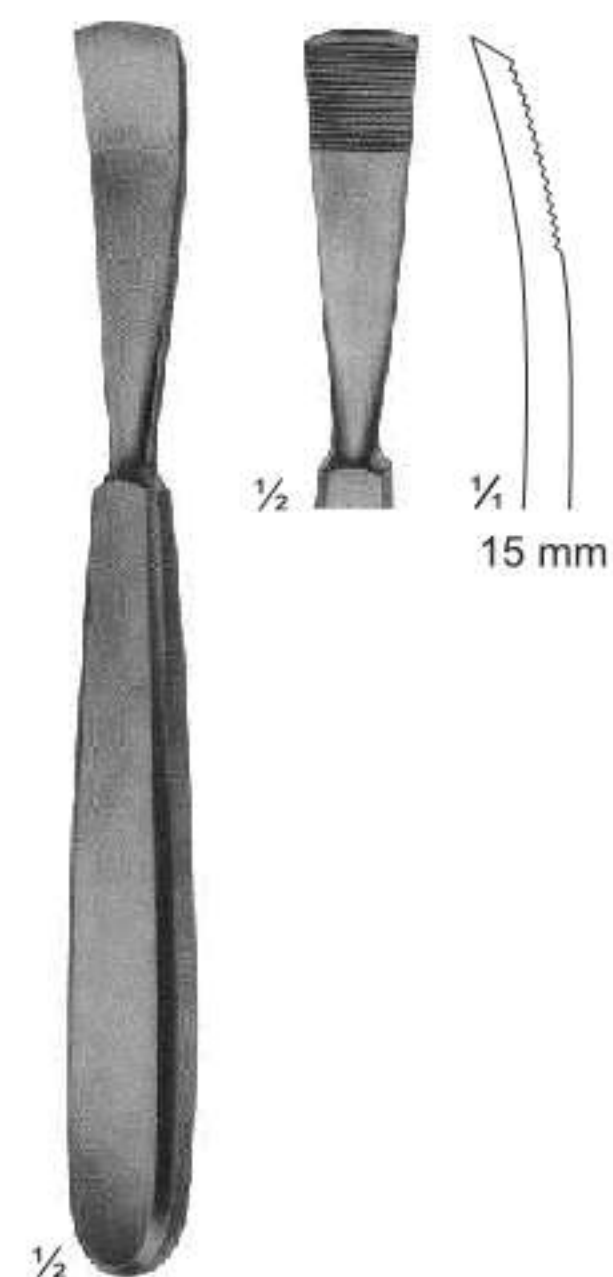

**20-193**  
JANSEN  
165 mm

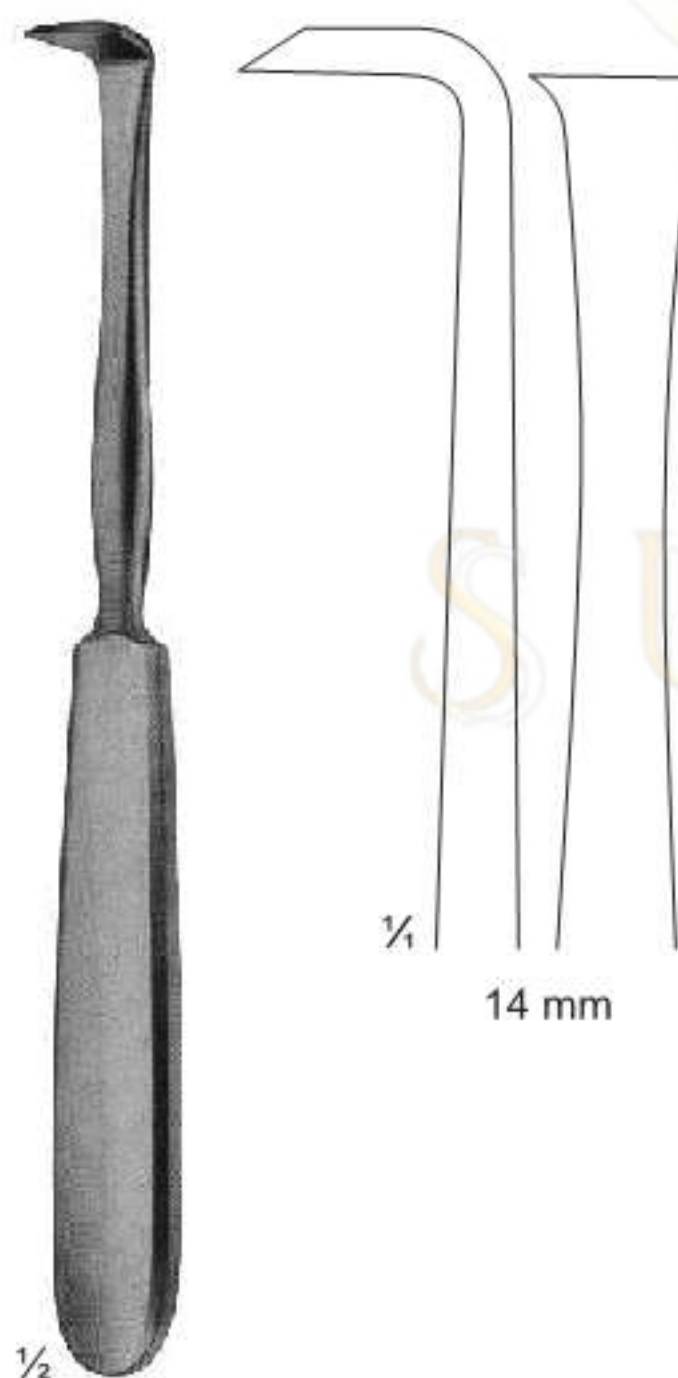

**20-194**  
LANGENBACK  
180 mm

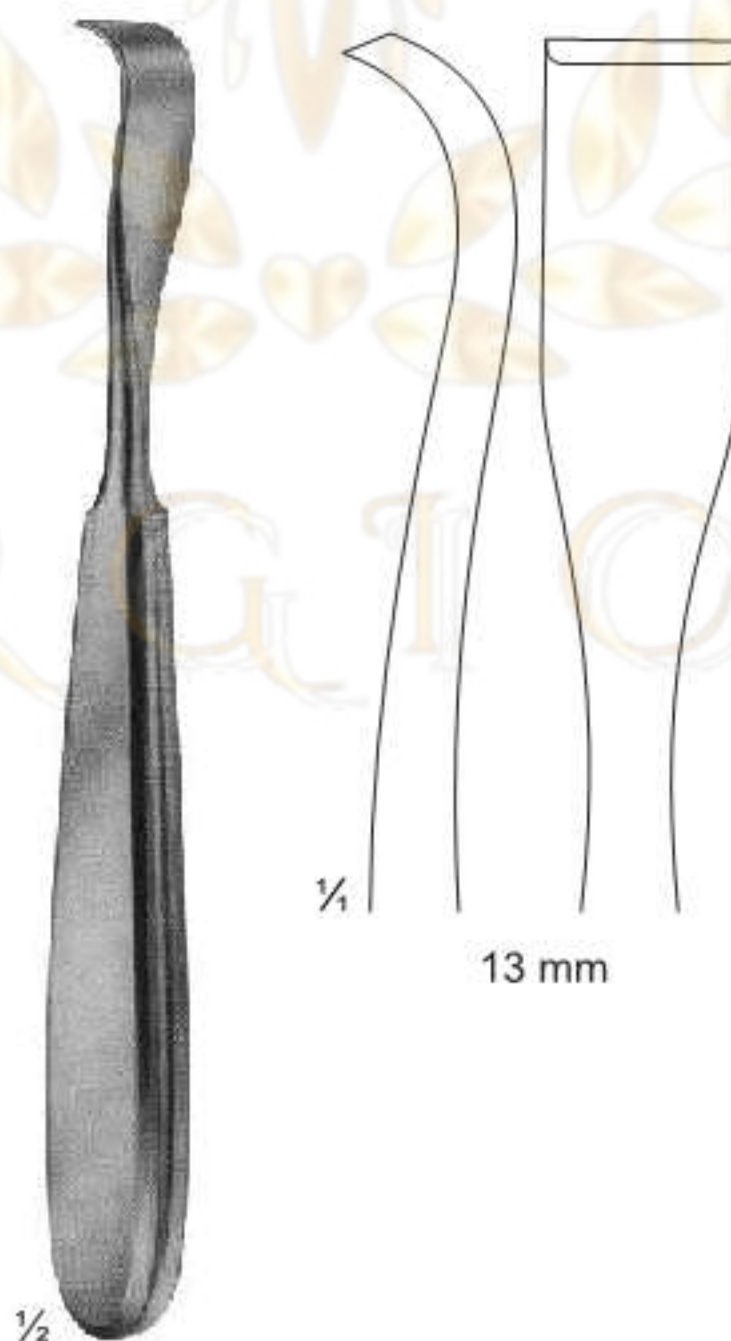

**20-195**  
SCHNEIDER  
175 mm

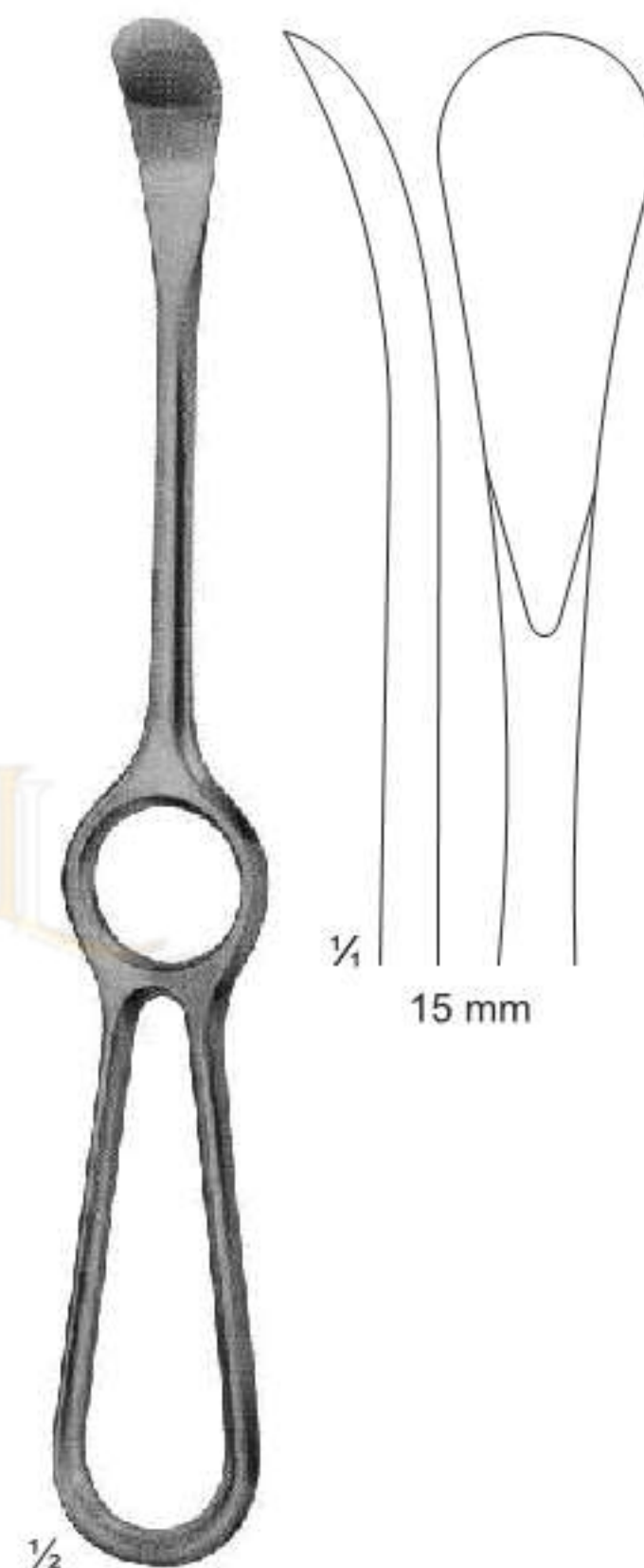

**20-196**  
SEDILLOT  
215 mm



# Raspatories

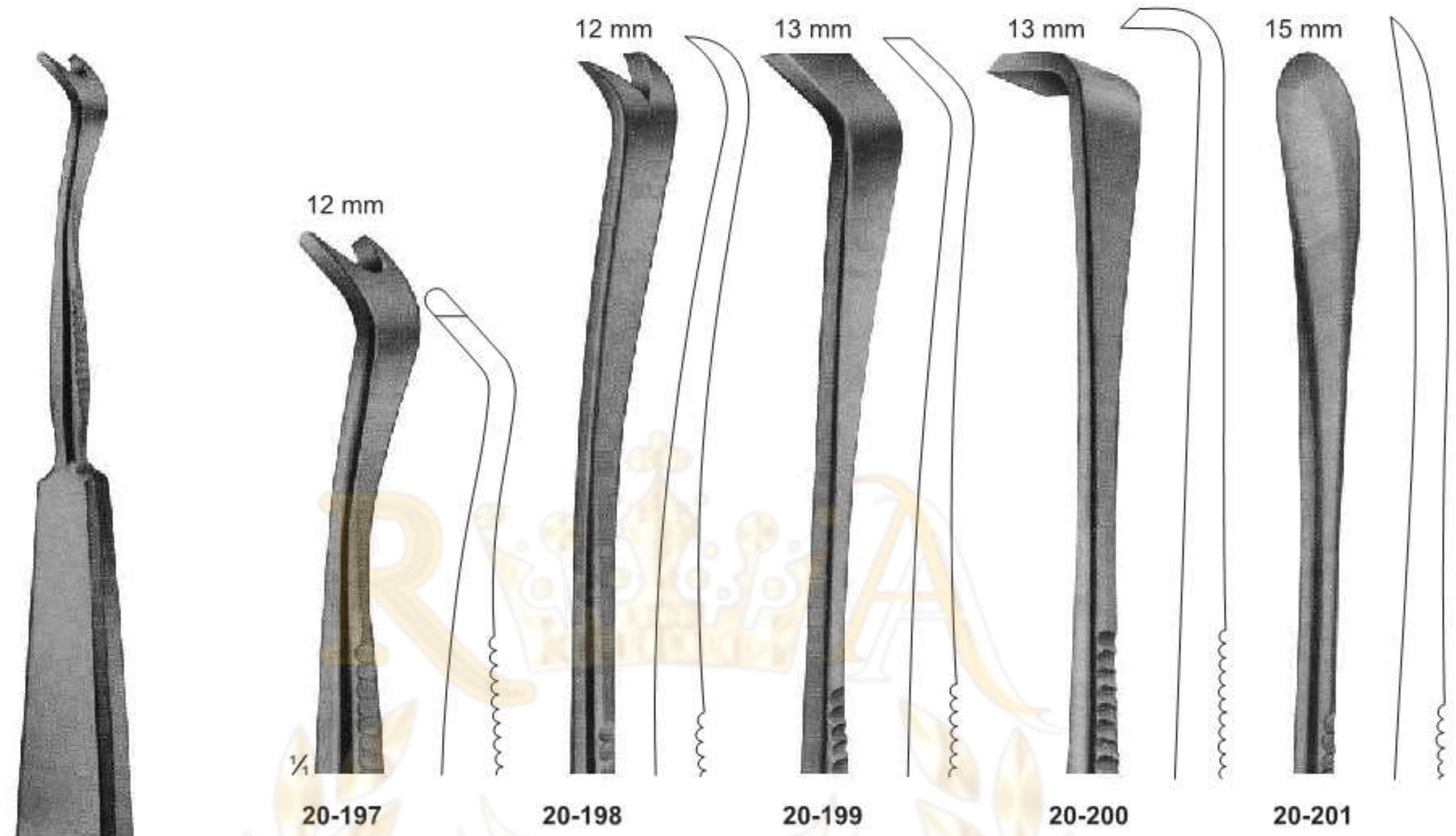

1/2  
20-197 - 201  
SEMB  
230 mm

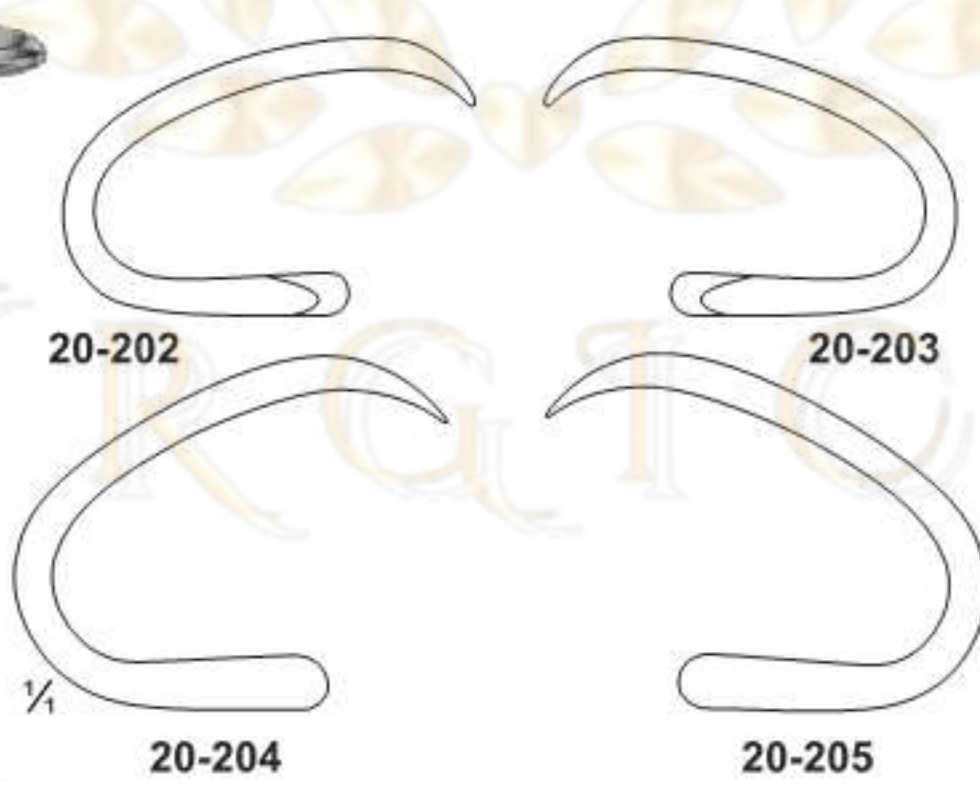

20-202 - 203  
DOYEN  
for children  
20-204 - 205  
for adults  
175 mm



20-206 - 207  
DOYEN  
240 mm

# Raspatories with HARTPRESS-handle



# Bone File and Rasps



# Bone File and Rasps

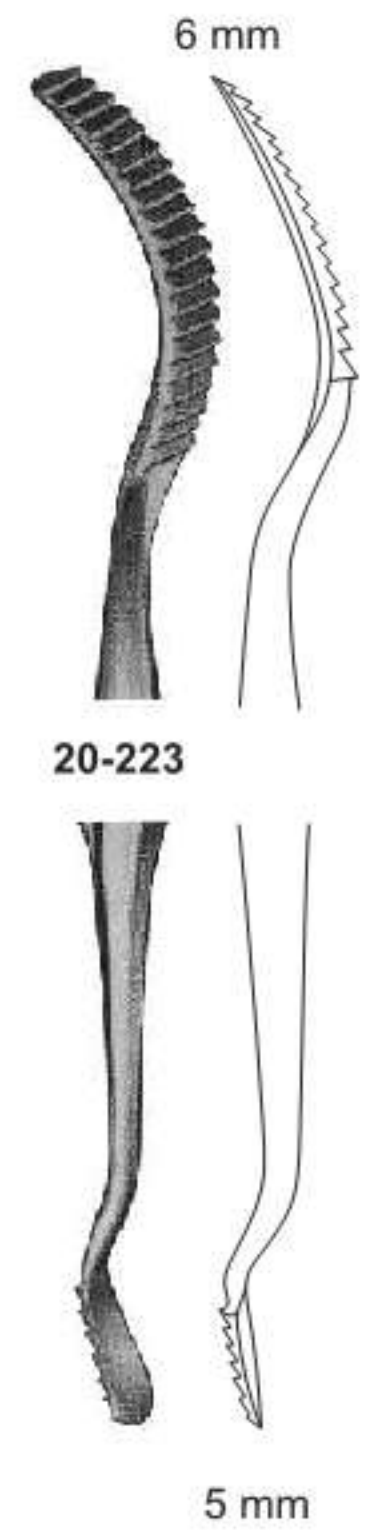
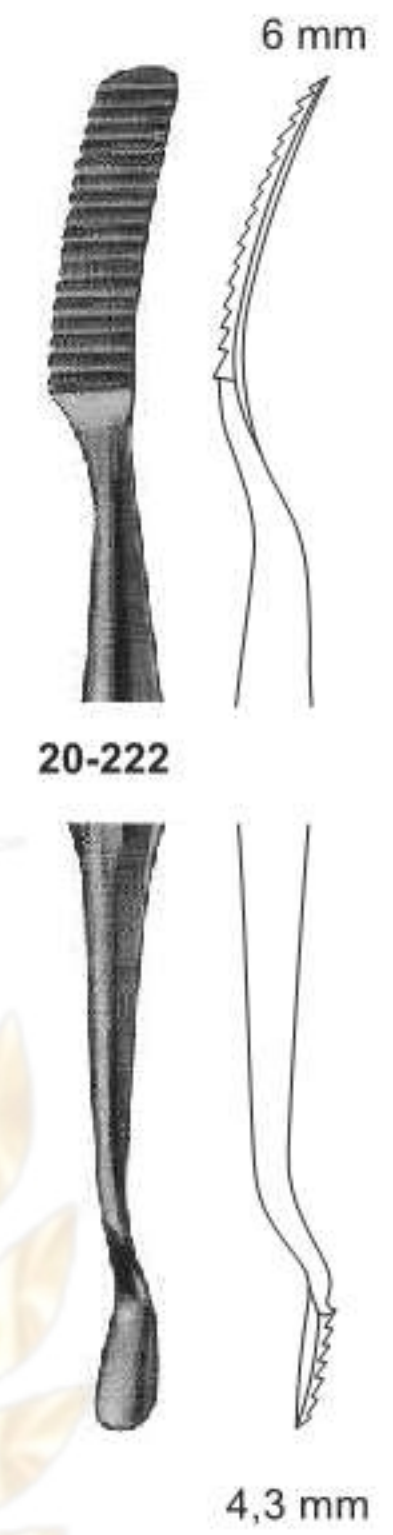
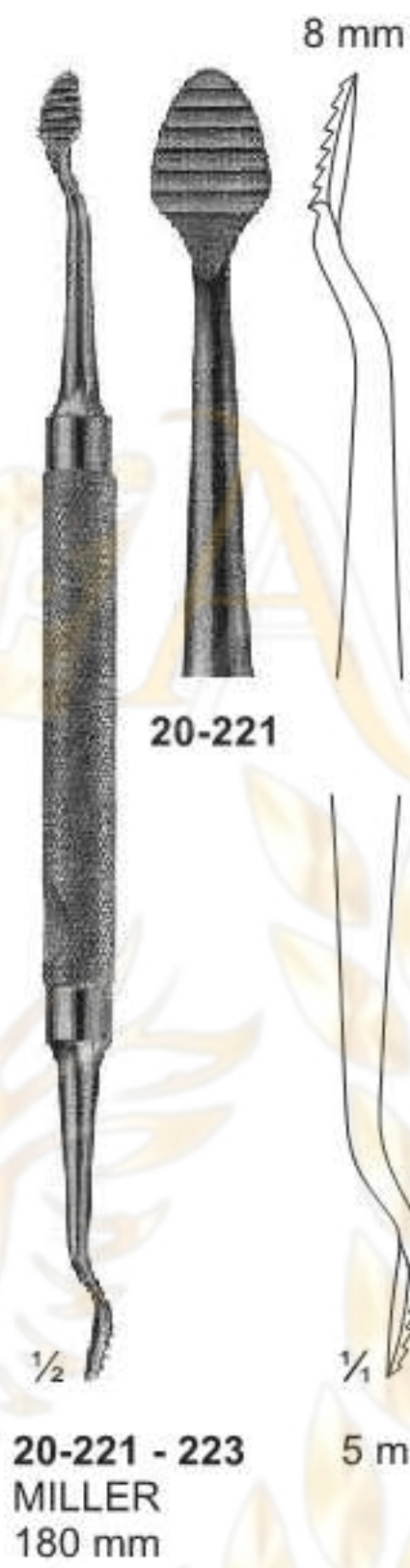

# Bone File and Rasps



# Bone Curettes



**20-233**  
JACOBSON  
140 mm



**20-234**  
MARTINI  
140 mm



**20-235**  
MARTINI  
140 mm



**20-236**  
WILLIGER  
145 mm



**20-237**  
JANSEN  
160 mm



**20-238**  
BARTH  
180 mm

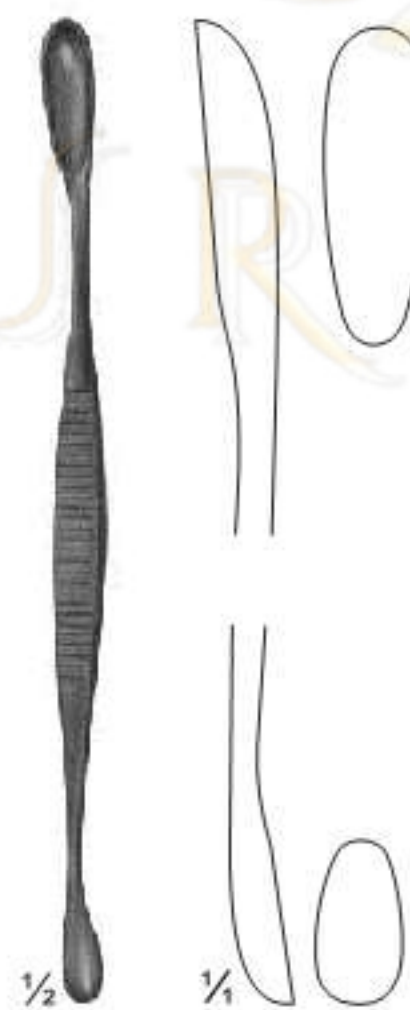

**20-239**  
VOLKMANN  
130 mm



**20-240**  
VOLKMANN  
145 mm

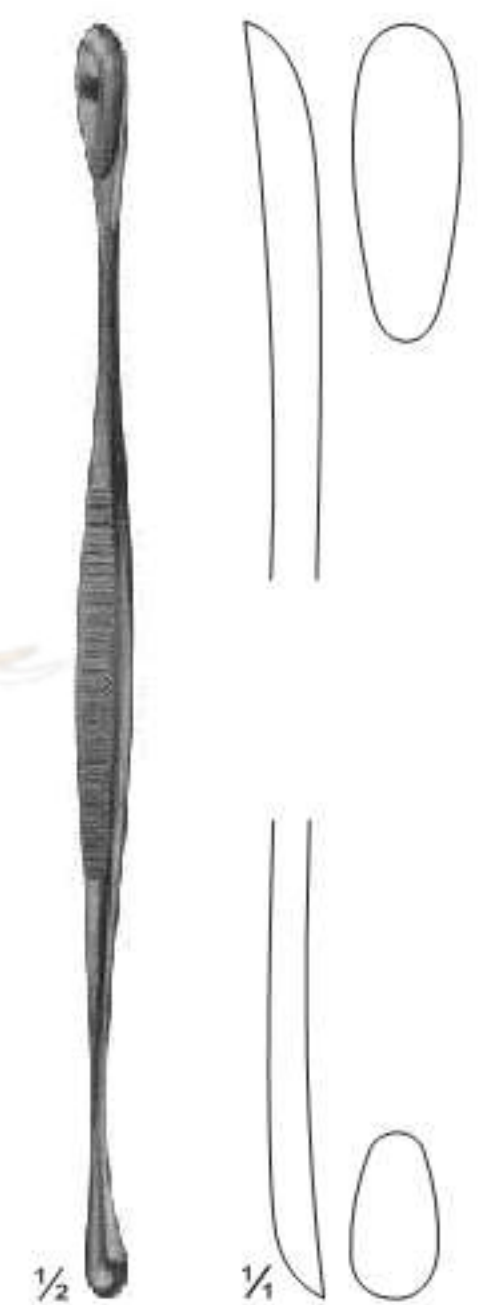

**20-241**  
VOLKMANN  
170 mm

# Bone Curettes



**20-242**  
JANSEN  
160 mm



**20-243**  
HEMINGWAY  
170 mm



**20-244**  
HEMINGWAY  
175 mm



**20-245**  
LUCAS  
180 mm

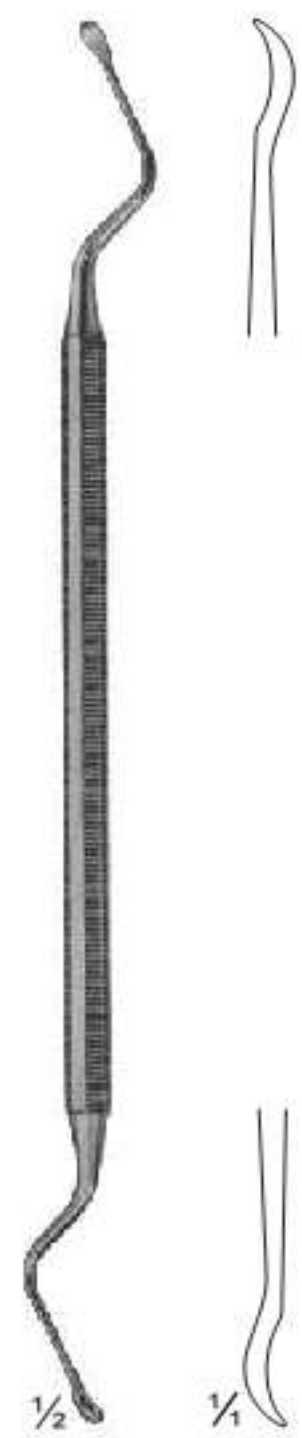

**20-246**  
LUCAS  
185 mm



**20-247 - 248**  
KERPEL  
145 mm



**20-249 - 250**  
KERPEL  
145 mm

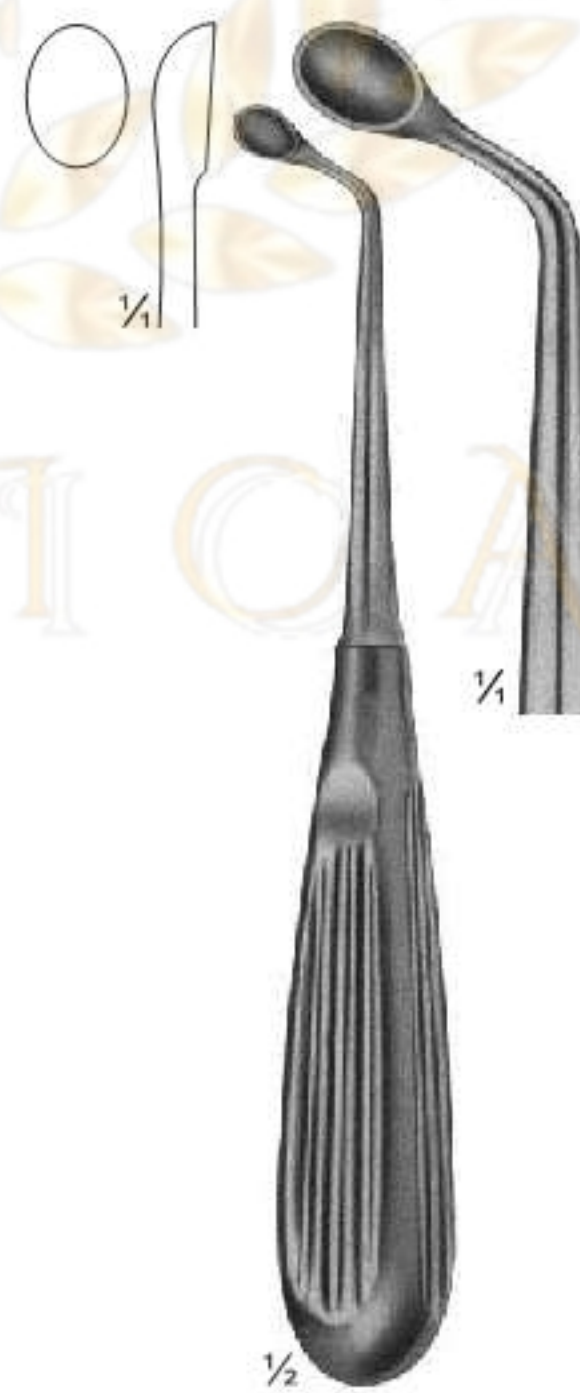

**20-251**  
UFFENDORDE  
170 mm



**20-252**  
UFFENDORDE  
170 mm

# Bone Currettes



1/2

**20-253 - 259**  
BRUNS  
165 mm



**20-253**  
3 mm  
Fig: 000



**20-254**  
4 mm  
00



**20-255**  
5 mm  
0



**20-256**  
6 mm  
Fig: 1



**20-257**  
8 mm  
2



**20-258**  
10 mm  
3

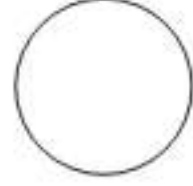

**20-259**  
12 mm  
4



1/2

**20-260 - 266**  
SCHEIDE  
170 mm



**20-260**  
2,5 mm  
Fig: 000



**20-261**  
3,4 mm  
00



**20-262**  
4,2 mm  
0



**20-263**  
5,2 mm  
Fig: 1



**20-264**  
6,3 mm  
2



**20-265**  
7,4 mm  
3

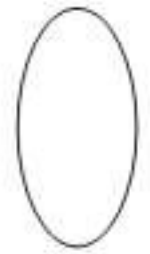

**20-266**  
8 mm  
4



1/2

**20-267 - 276**  
VOLKMANN  
170 mm

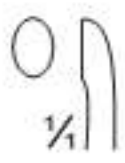

**20-267**  
2,8 mm  
Fig: 0000



**20-268**  
3,6 mm  
000



**20-269**  
4,4 mm  
00



**20-270**  
5,2 mm  
0



**20-271**  
6,8 mm  
1

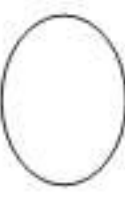

**20-272**  
8,5 mm  
Fig: 2



**20-273**  
10 mm  
3



**20-274**  
11,5 mm  
4



**20-275**  
13 mm  
5



**20-276**  
14,5 mm  
6



**20-277**  
3,4 mm  
Fig: 00



**20-278**  
5,2 mm  
1



1/2

**20-277 - 278**  
WILLIGER  
170 mm



# Bone Curettes

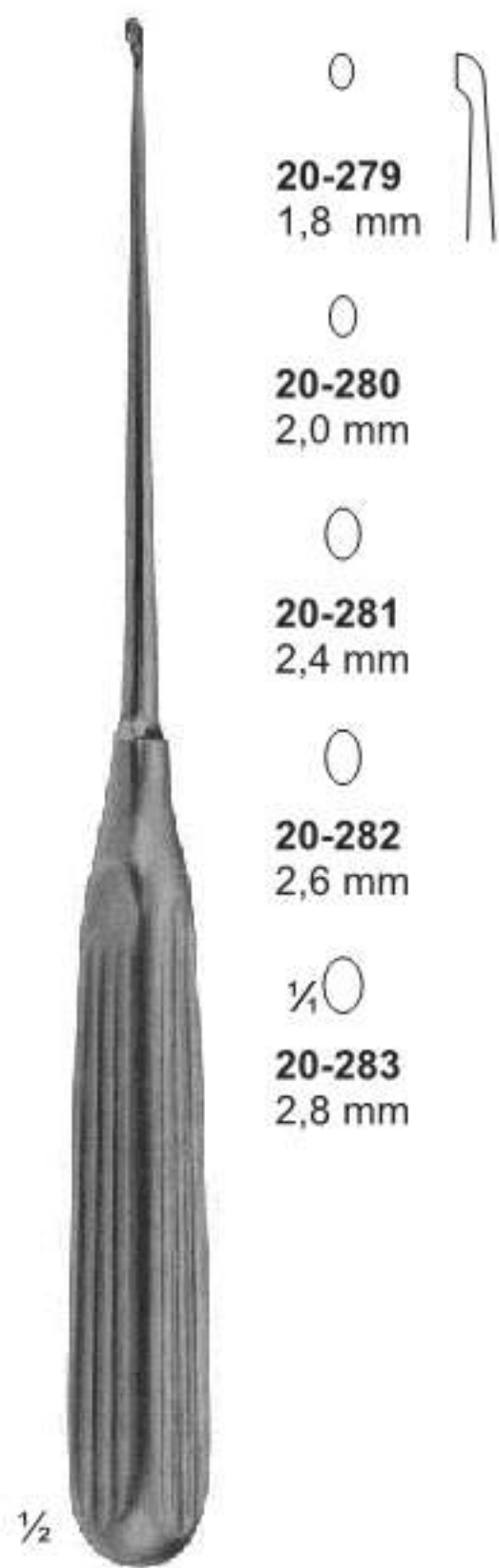

-  20-279  
1,8 mm
-  20-280  
2,0 mm
-  20-281  
2,4 mm
-  20-282  
2,6 mm
-  20-283  
2,8 mm

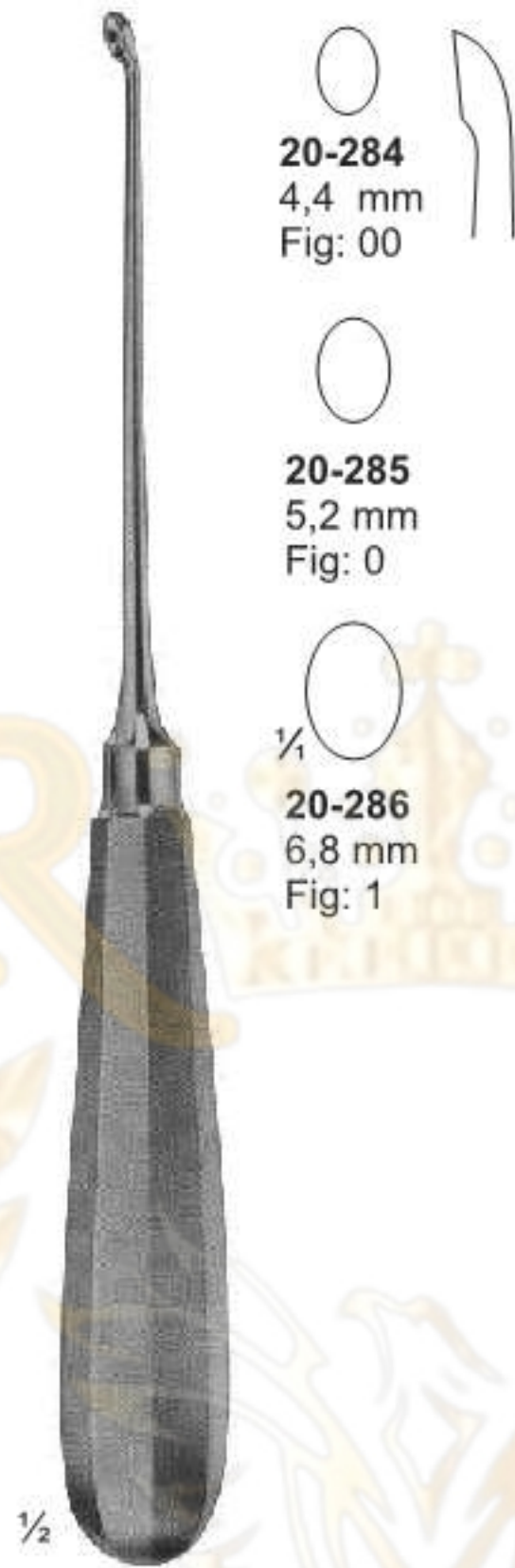

20-279 - 283  
LEMPERT  
215 mm



-  20-284  
4,4 mm  
Fig: 00
-  20-285  
5,2 mm  
Fig: 0
-  20-286  
6,8 mm  
Fig: 1

20-284 - 286  
HALLE  
215 mm

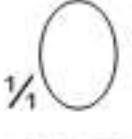

-  20-287  
4,4 mm  
Fig: 0000
-  20-288  
5,2 mm  
Fig: 000
-  20-289  
5,2 mm  
Fig: 00
-  20-290  
6,8 mm  
Fig: 0



20-287 - 290  
DAUBENSPECK  
200 mm



-  20-291  
3,6 mm  
Fig: 000
-  20-292  
4,4 mm  
Fig: 00
-  20-293  
5,2 mm  
Fig: 0
-  20-294  
6,8 mm  
Fig: 1



20-291 - 294  
250 mm

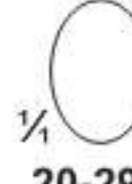

-  20-295  
3,6 mm  
Fig: 000
-  20-296  
4,4 mm  
Fig: 00
-  20-297  
5,2 mm  
Fig: 0
-  20-298  
6,8 mm  
Fig: 1

20-295 - 298  
250 mm



-  20-299  
3 mm
-  20-300  
4 mm
-  20-301  
5 mm

20-299 - 301  
BUSHE  
250 mm

# Bone Curettes

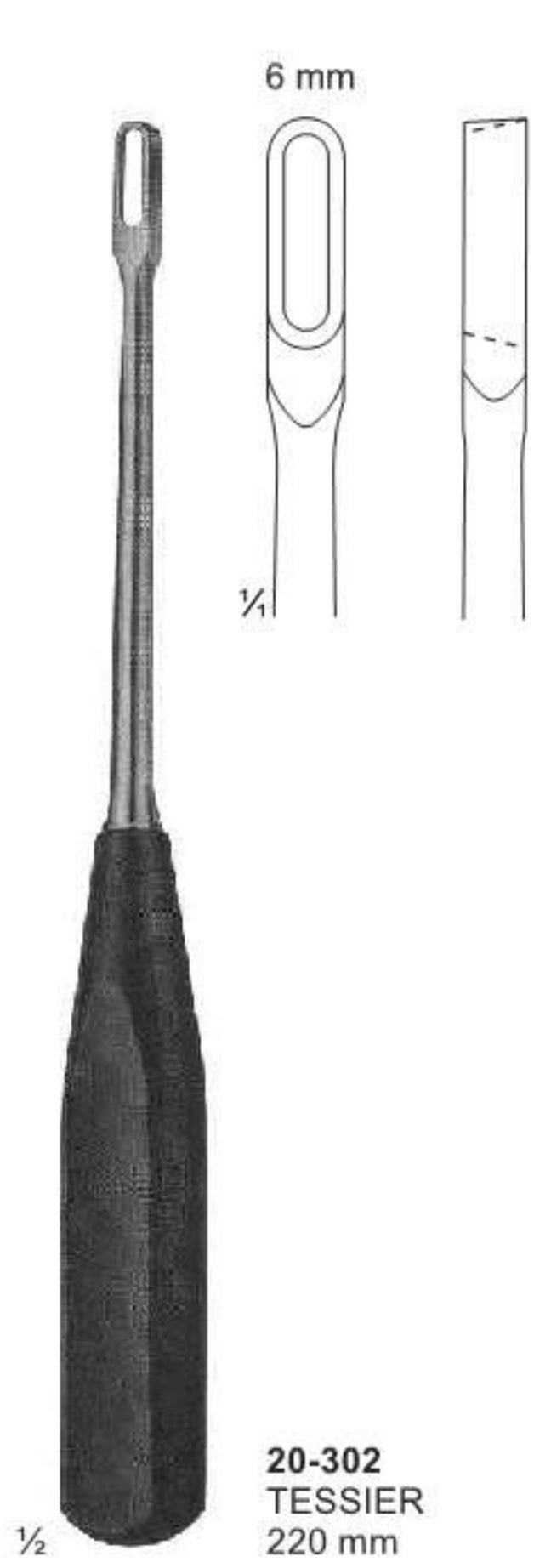

**20-302**  
TESSIER  
220 mm



**20-303**  
3,6 mm  
Fig: 000

**20-304**  
4,4 mm  
Fig: 00

**20-305**  
5,2 mm  
Fig: 0

**20-303 - 305**  
SIMON  
235 mm

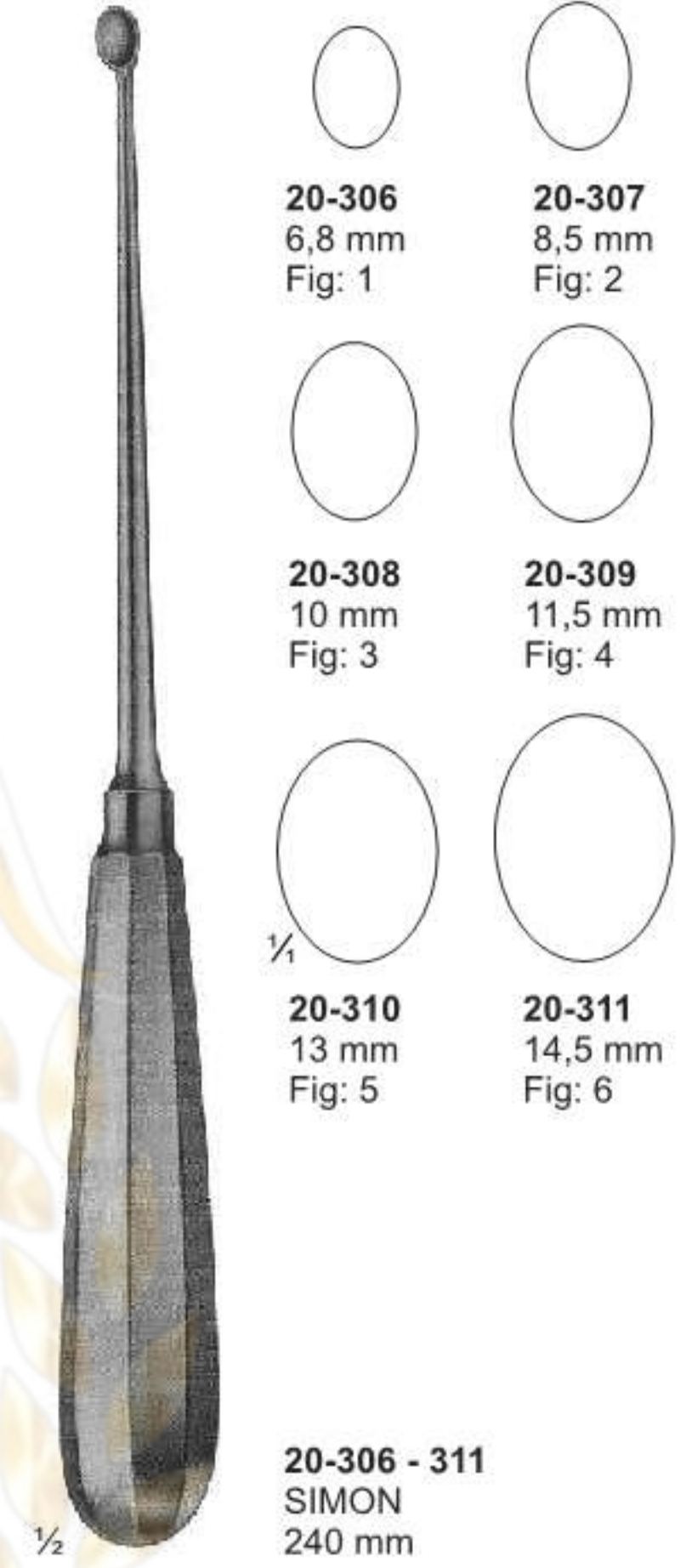

**20-306**  
6,8 mm  
Fig: 1

**20-307**  
8,5 mm  
Fig: 2

**20-308**  
10 mm  
Fig: 3

**20-309**  
11,5 mm  
Fig: 4

**20-310**  
13 mm  
Fig: 5

**20-311**  
14,5 mm  
Fig: 6

**20-306 - 311**  
SIMON  
240 mm

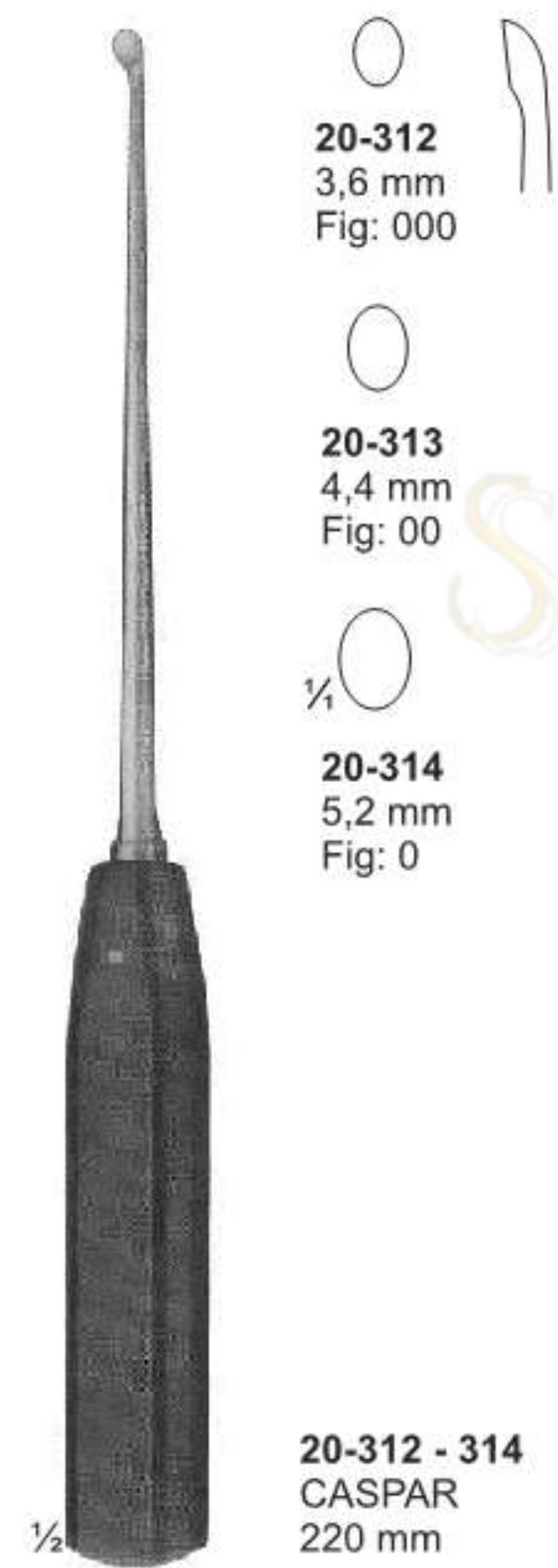

**20-312**  
3,6 mm  
Fig: 000

**20-313**  
4,4 mm  
Fig: 00

**20-314**  
5,2 mm  
Fig: 0

**20-312 - 314**  
CASPAR  
220 mm



**20-315**  
3,6 mm  
Fig: 000

**20-316**  
4,4 mm  
Fig: 00

**20-317**  
5,2 mm  
Fig: 0

**20-315 - 317**  
CASPAR  
220 mm

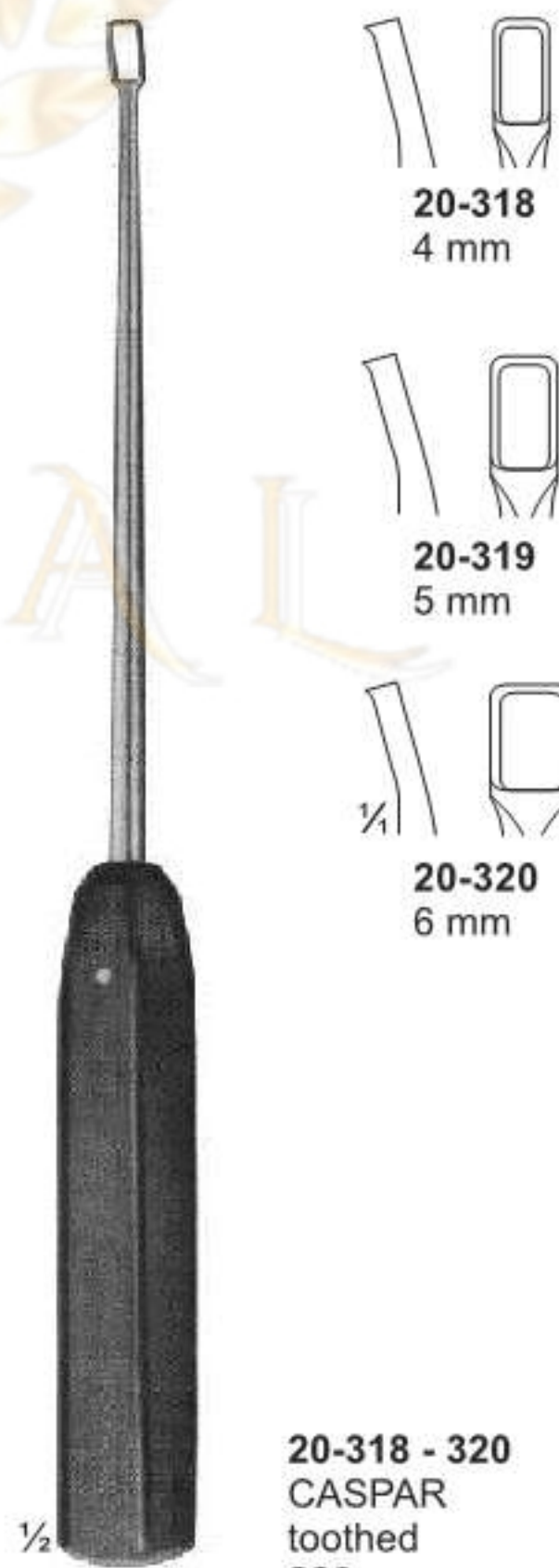

**20-318**  
4 mm

**20-319**  
5 mm

**20-320**  
6 mm

**20-318 - 320**  
CASPAR  
toothed  
220 mm

# Bone Currettes



20-321 - 324  
270 mm

4,4 mm



Fig. 00  
20-321

6,8 mm



Fig. 1  
20-322

8,5 mm



Fig. 2  
20-323

10 mm



Fig. 3  
20-324



20-325 - 332  
SYPERT  
380 mm

2,8 mm



Fig. 0000  
20-325

3,6 mm



Fig. 000  
20-326

5,2 mm



Fig. 0  
20-327

10,0 mm



Fig. 3  
20-328

2,8 mm

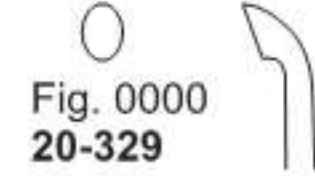

Fig. 0000  
20-329

3,6 mm



Fig. 000  
20-330

5,2 mm

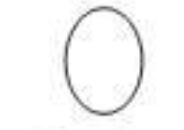

Fig. 0  
20-331

10,0 mm



Fig. 3  
20-332

# Mallets



Ø 20 mm

½

**21-101**  
MEAD  
185 g  
with interchangeable  
plastic disks  
190 mm  
**21-102**  
pair of spare disks



½

**21-103**  
140 g  
with interchangeable  
plastic disks  
185 mm  
**21-104**  
pair of spare disks



Ø 25 mm

½

**21-105**  
COTTLE  
140 g  
1 Seite convex  
1 Side convex  
185 mm



Ø 22 mm

½

**21-106**  
165 g  
lead filled head  
190 mm

# Mallets



Ø27 mm

½

**21-107**  
HAJEK  
140 g  
215 mm



Ø30 mm

½

**21-108**  
215 g  
with interchangeable  
plastic disks  
245 mm  
**21-109**  
pair of spare disks



Ø35 mm

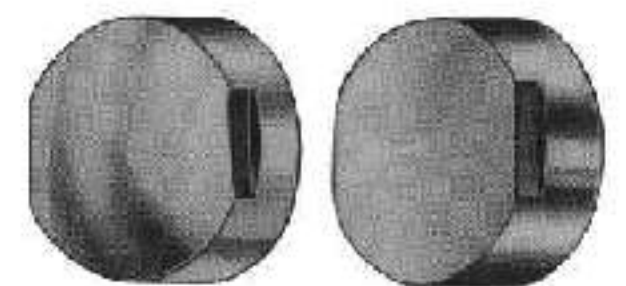

**21-111**  
1 metal disks, flat  
1 metal disks, convex

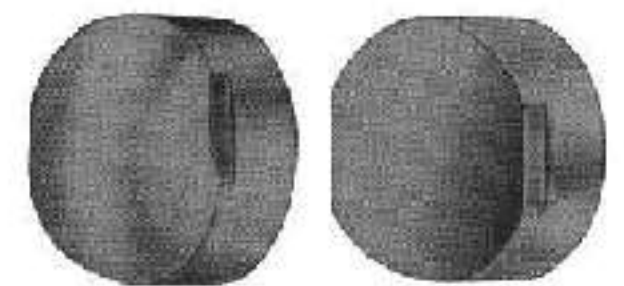

**21-112**  
1 plastic disks, flat  
1 plastic disks, convex

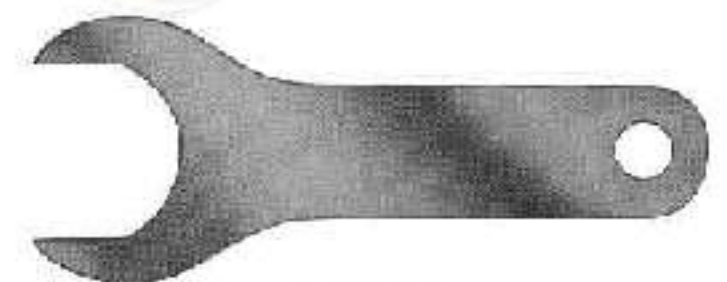

**21-113**  
Wrench

**21-110 - 113**  
WAGNER  
complete with:  
1 pair of metal disks and  
1 pair of plastic disks and  
1 wrench 566  
235 mm

Mallet without disks 130 g

# Mallets



**21-114**  
BERGMANN  
245 mm



**21-115**  
BERGMANN  
235 mm



**21-116**  
OMBREDANNE  
240 mm

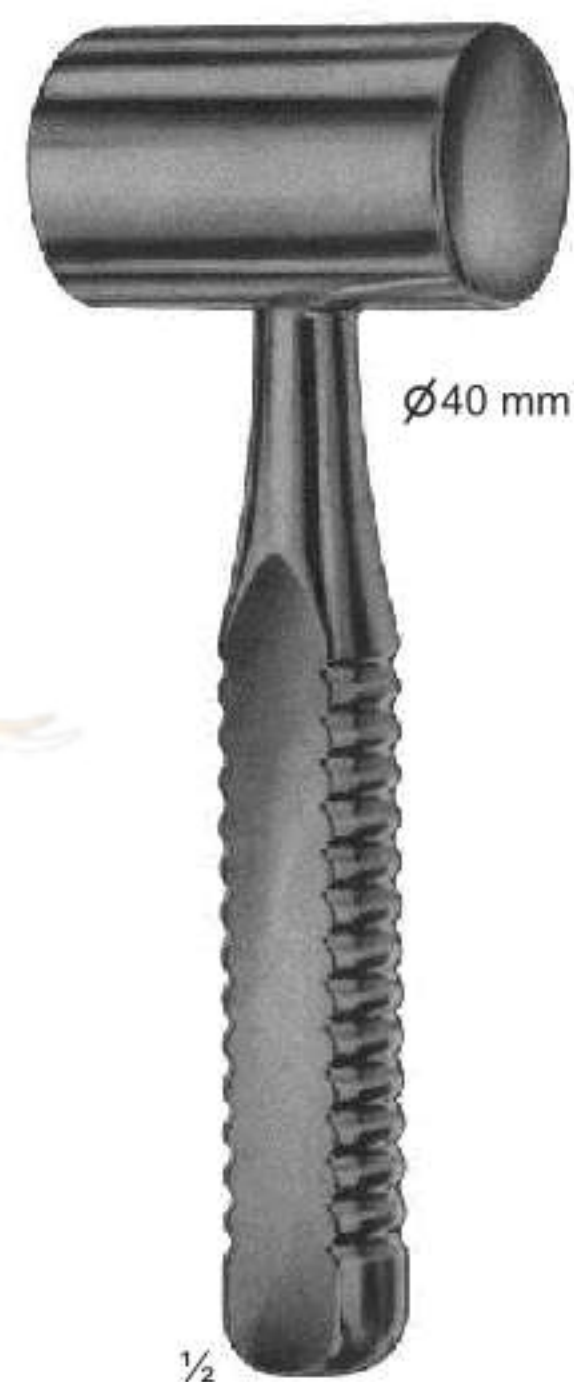

**21-117**  
HEATH  
copper filled head  
700 g  
185 mm

# Tampers - Osteotomes, Chisels and Gouges

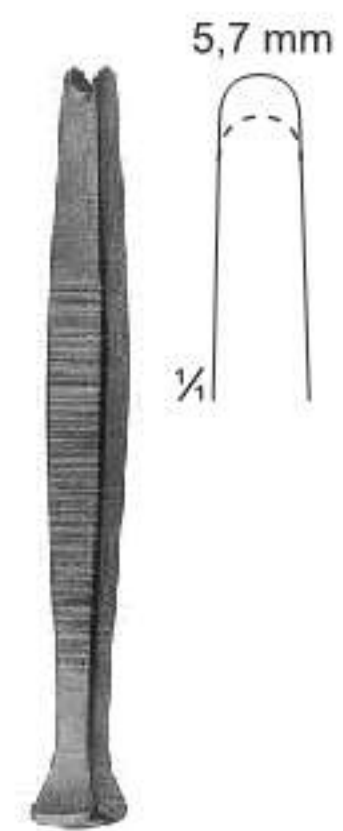

**21-118**  
Haase  
100 mm



**21-119 - 120**  
PASSOW  
120 mm



**21-121 - 123**  
CASPER  
200 mm



**21-124 - 126**  
200 mm

- 21-121  
ø3 mm
- 21-122  
ø5 mm
- 1/4 21-123  
ø8 mm

- 21-124  
ø12 mm
- 21-125  
ø14 mm
- 1/4 21-126  
ø16 mm

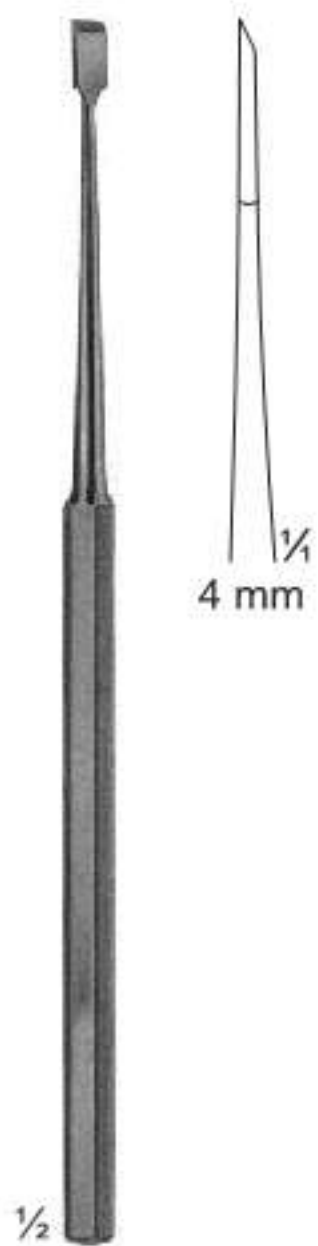

**21-127**  
FREER  
Chisel  
160 mm



**21-128**  
FREER  
Chisel, curved  
160 mm

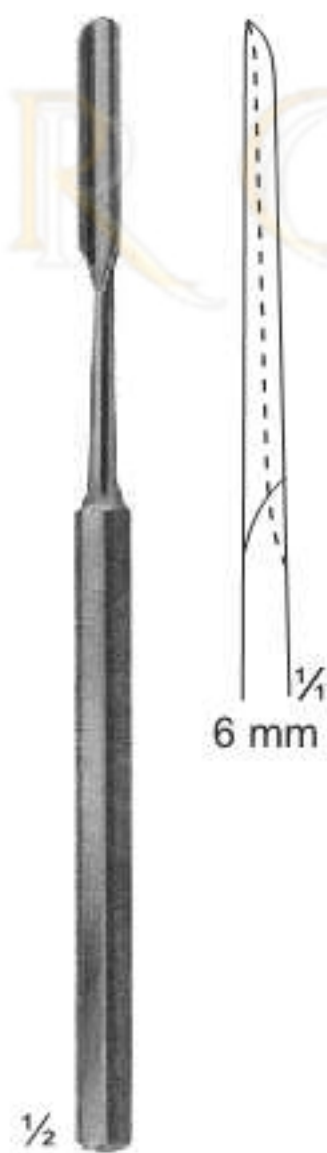

**21-129**  
FREER  
Gouge  
150 mm

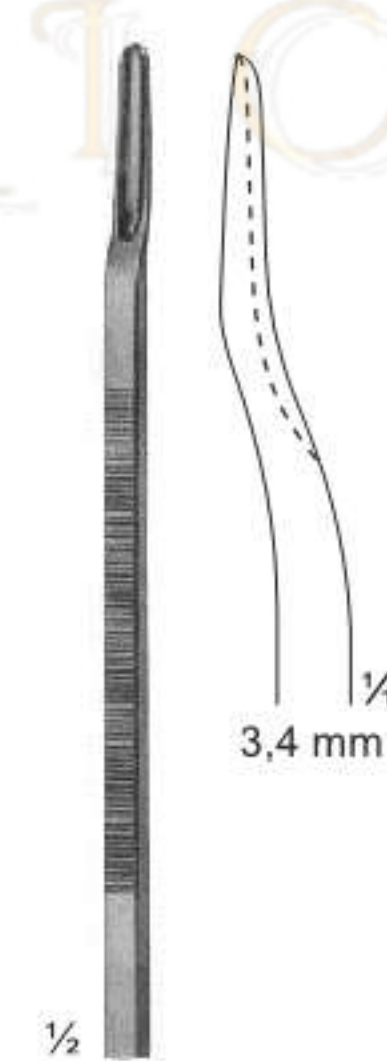

**21-130**  
Scaphoid gouge,  
downwards curved  
135 mm

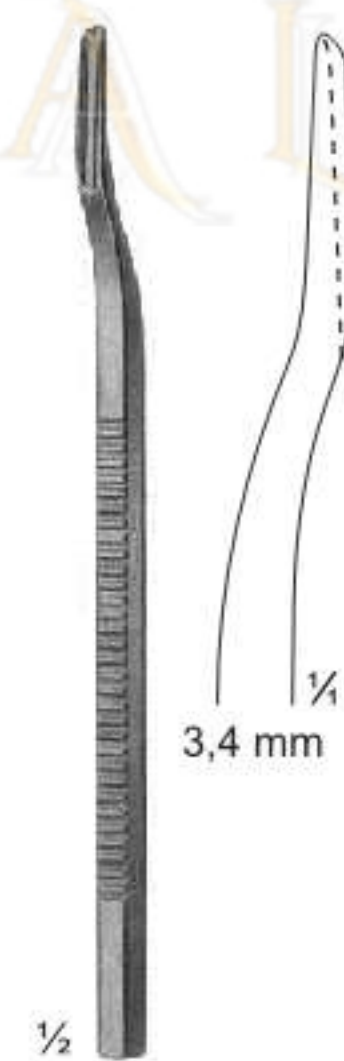

**21-131**  
Scaphoid gouge,  
upwards curved  
135 mm



**21-131A - 133**  
Mannerfelt  
**21-131A** 4 mm  
**21-132** 6 mm  
**21-133** 8 mm  
155 mm

# Osteotomes Chisels and Gouges



**21-134**  
Mannerfelt  
155 mm

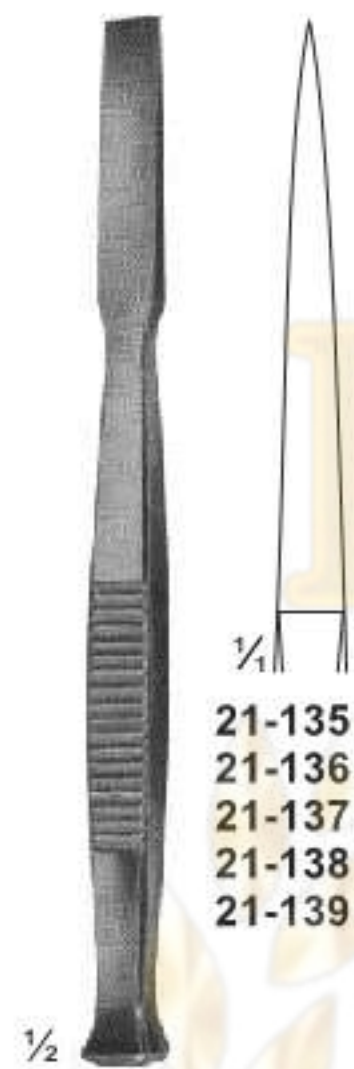

**21-135 - 139**  
Osteotome  
140 mm

- 21-135 4 mm
- 21-136 6 mm
- 21-137 8 mm
- 21-138 10 mm
- 21-139 12 mm



**21-140 - 144**  
Chisels  
140 mm

- 21-140 4 mm
- 21-141 6 mm
- 21-142 8 mm
- 21-143 10 mm
- 21-144 12 mm

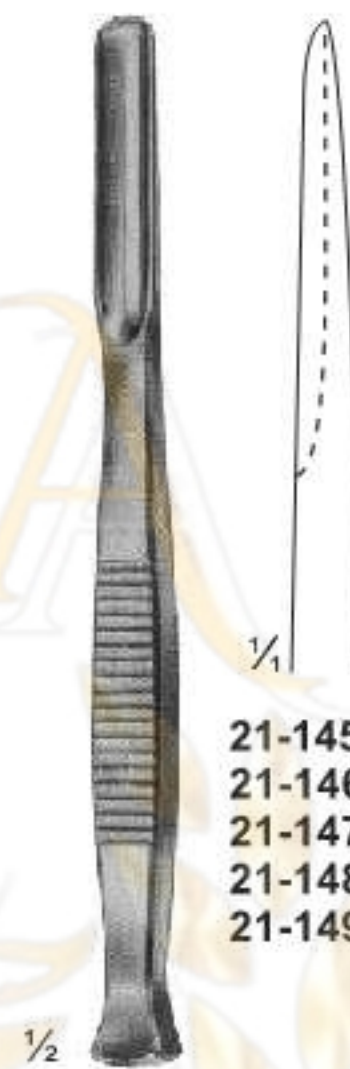

**21-145 - 149**  
Gouges  
140 mm

- 21-145 4 mm
- 21-146 6 mm
- 21-147 8 mm
- 21-148 10 mm
- 21-149 12 mm

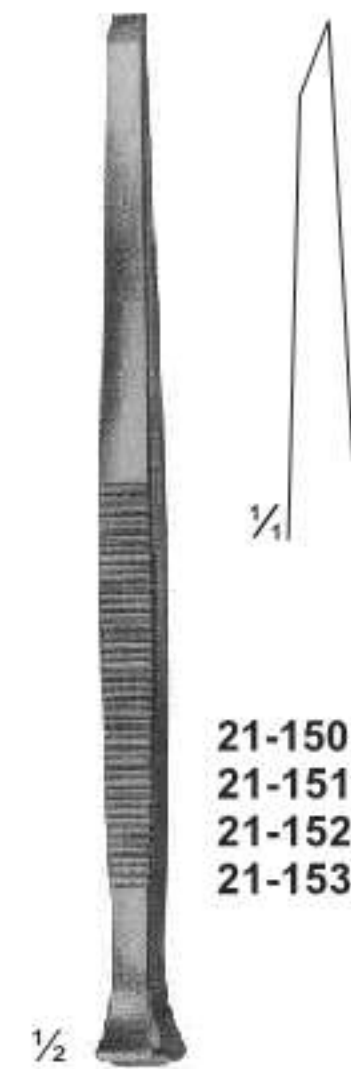

**PARTSCH**  
**21-150 - 153**  
Chisels  
140 mm

- 21-150 3 mm
- 21-151 4 mm
- 21-152 5 mm
- 21-153 6 mm

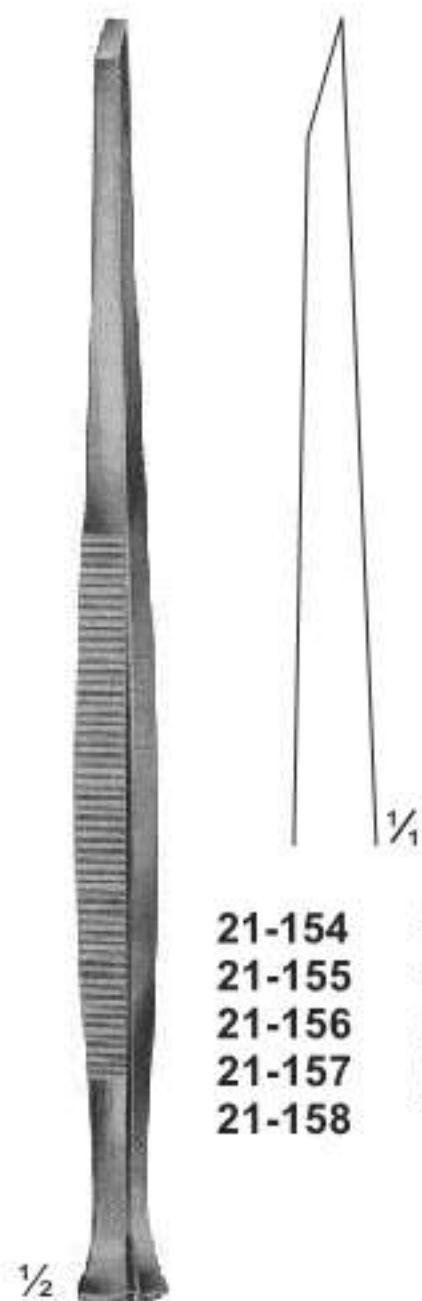

**PARTSCH**  
**21-154 - 158**  
Chisels  
170 mm

- 21-154 3 mm
- 21-155 4 mm
- 21-156 5 mm
- 21-157 6 mm
- 21-158 7 mm

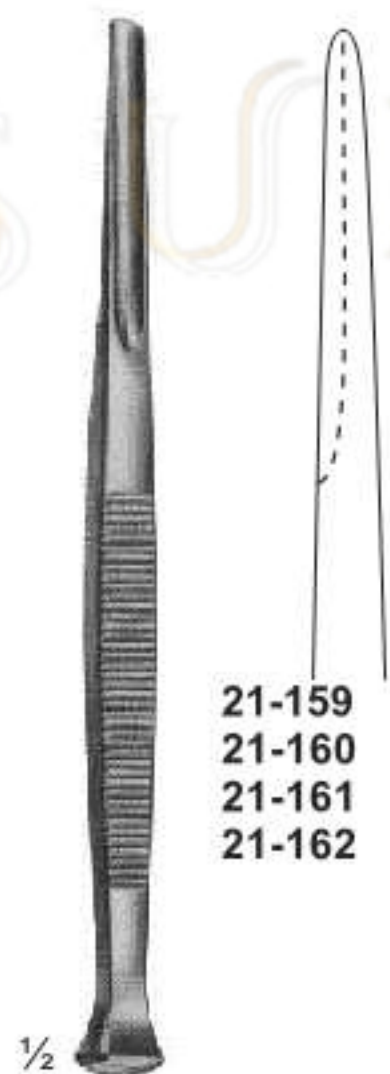

**PARTSCH**  
**21-159 - 162**  
Gouges  
140 mm

- 21-159 3 mm
- 21-160 4 mm
- 21-161 5 mm
- 21-162 6 mm

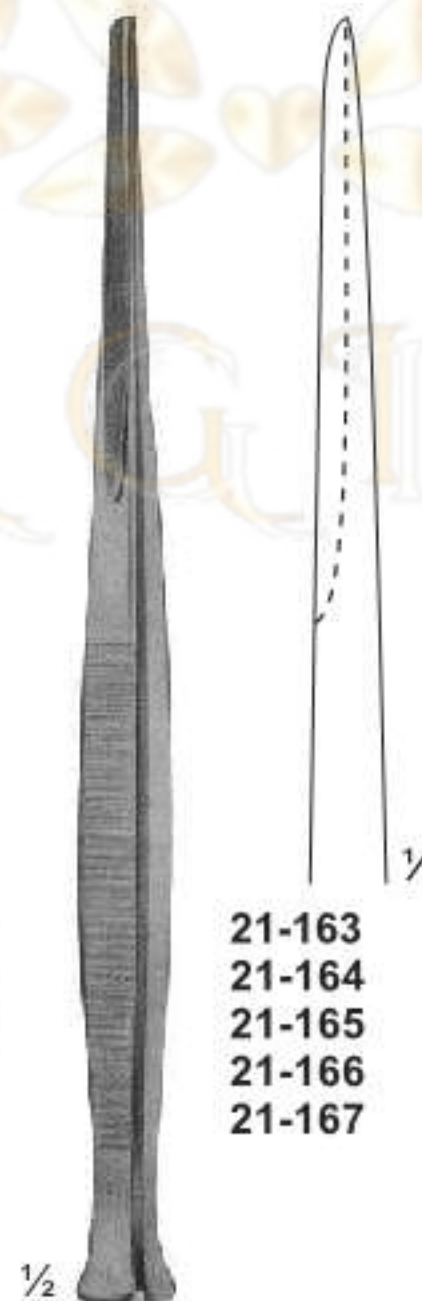

**PARTSCH**  
**21-163 - 167**  
Gouges  
170 mm

- 21-163 3 mm
- 21-164 4 mm
- 21-165 5 mm
- 21-166 6 mm
- 21-167 7 mm



**LUCAS**  
**21-168 - 169**  
Chisels  
160 mm

- 21-168 4 mm
- 21-169 6 mm



**LUCAS**  
**21-170 - 171**  
Gouges  
160 mm

- 21-170 3 mm
- 21-171 5 mm



# Osteotomes Chisels and Gouges

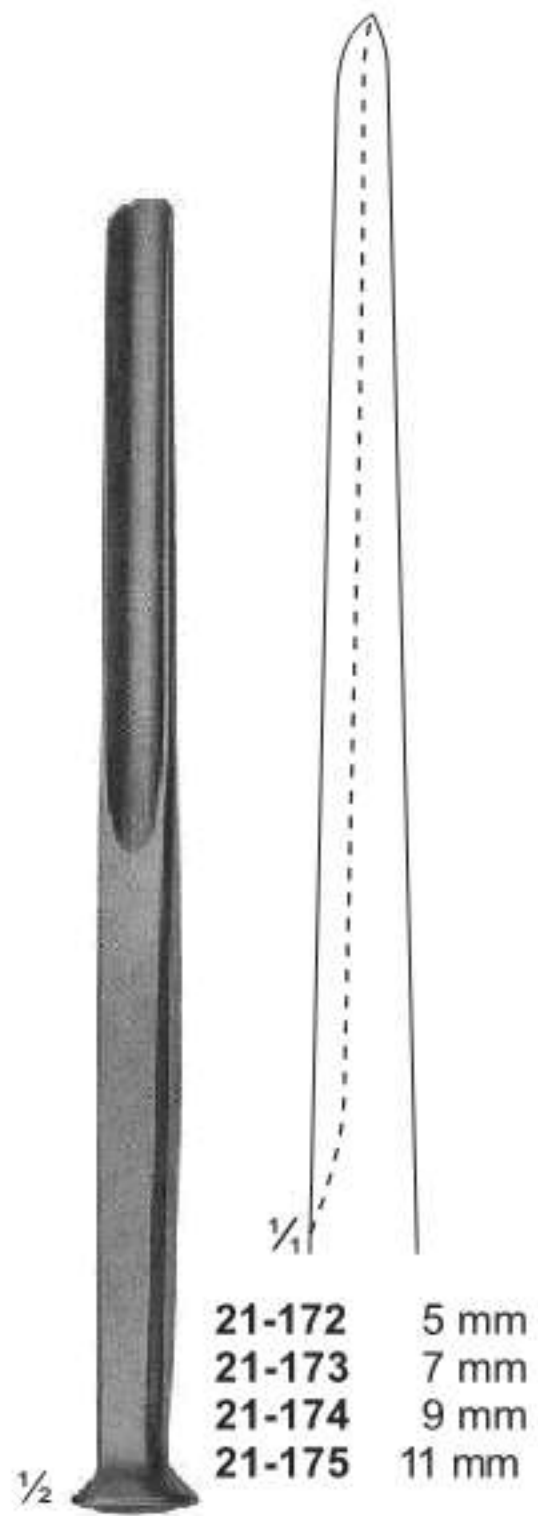

**ALEXANDER**  
21-172 - 175  
Gouges  
170 mm

- |        |       |
|--------|-------|
| 21-172 | 5 mm  |
| 21-173 | 7 mm  |
| 21-174 | 9 mm  |
| 21-175 | 11 mm |



**LAMBOTTE**  
21-176 - 181  
Osteotome  
125 mm

- |        |       |
|--------|-------|
| 21-176 | 4 mm  |
| 21-177 | 6 mm  |
| 21-178 | 8 mm  |
| 21-179 | 10 mm |
| 21-180 | 12 mm |
| 21-181 | 15 mm |

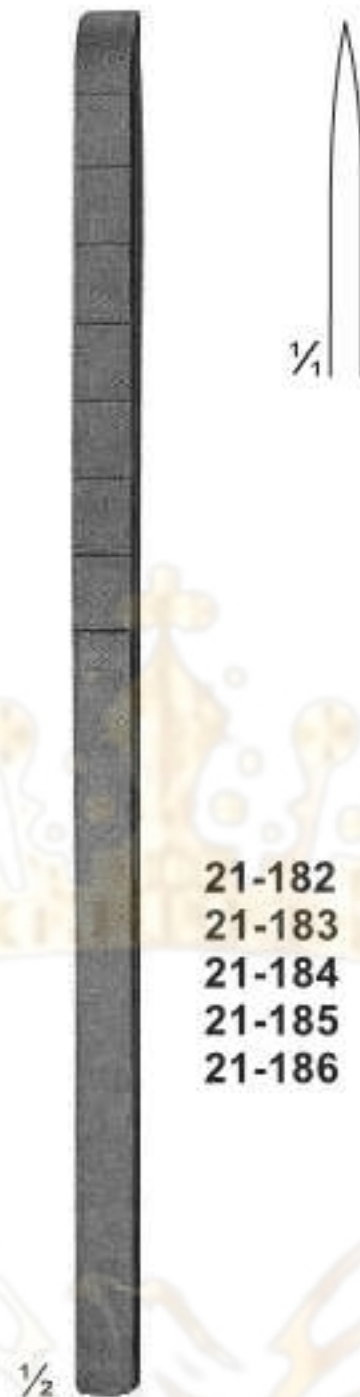

**COTTLE**  
21-182 - 186  
Osteotome with depth  
markings  
180 mm

- |        |       |
|--------|-------|
| 21-182 | 4 mm  |
| 21-183 | 6 mm  |
| 21-184 | 8 mm  |
| 21-185 | 10 mm |
| 21-186 | 12 mm |

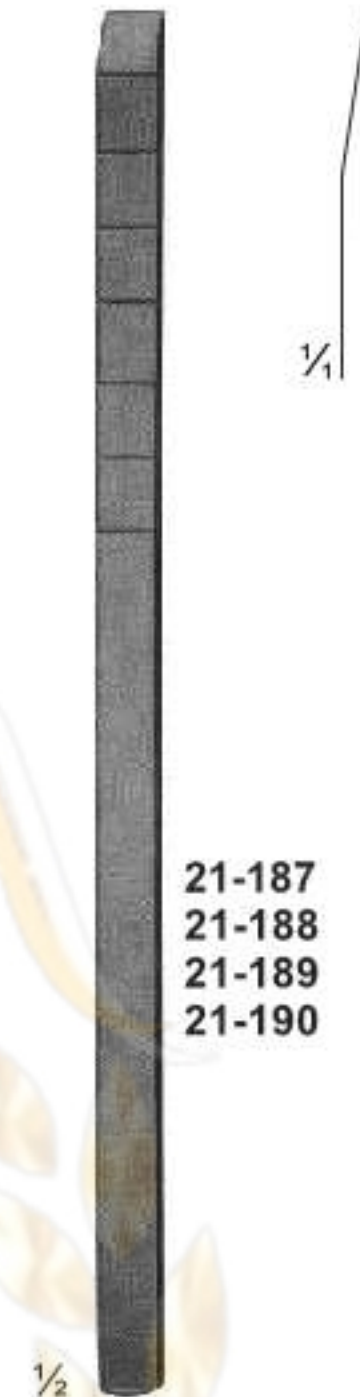

**COTTLE**  
21-187 - 190  
Chisel-Osteotomes  
with depth markings  
180 mm

- |        |       |
|--------|-------|
| 21-187 | 4 mm  |
| 21-188 | 7 mm  |
| 21-189 | 9 mm  |
| 21-190 | 12 mm |



**COTTLE**  
21-191  
Fishtail Chisel,  
with protected ends  
180 mm



**STILLE**  
21-192 - 196  
Chisels  
205 mm

- |        |       |
|--------|-------|
| 21-192 | 10 mm |
| 21-193 | 12 mm |
| 21-194 | 15 mm |
| 21-195 | 20 mm |
| 21-196 | 25 mm |

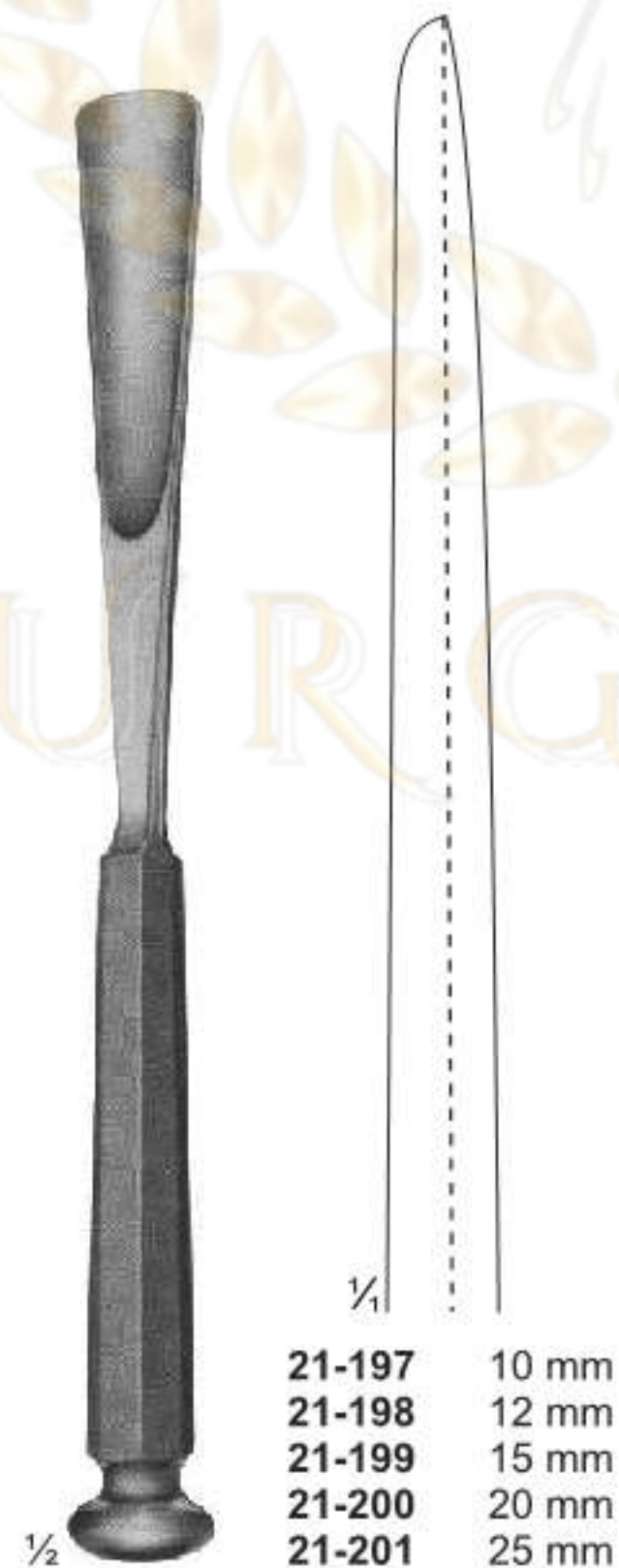

**STILLE**  
21-197 - 201  
Gouges  
205 mm

- |        |       |
|--------|-------|
| 21-197 | 10 mm |
| 21-198 | 12 mm |
| 21-199 | 15 mm |
| 21-200 | 20 mm |
| 21-201 | 25 mm |

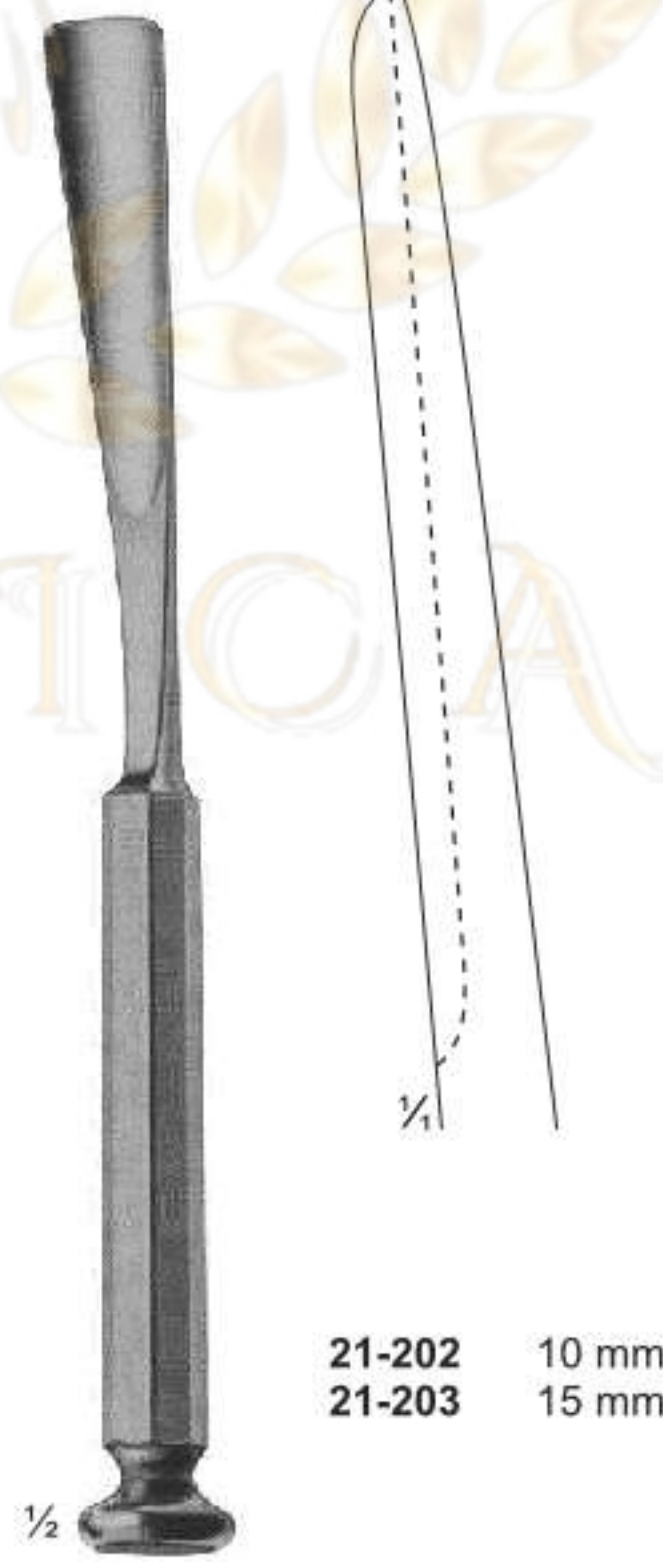

**WALTER**  
21-202 - 203  
Osteotomes  
gouges for taking  
grafts from the rib  
205 mm

- |        |       |
|--------|-------|
| 21-202 | 10 mm |
| 21-203 | 15 mm |

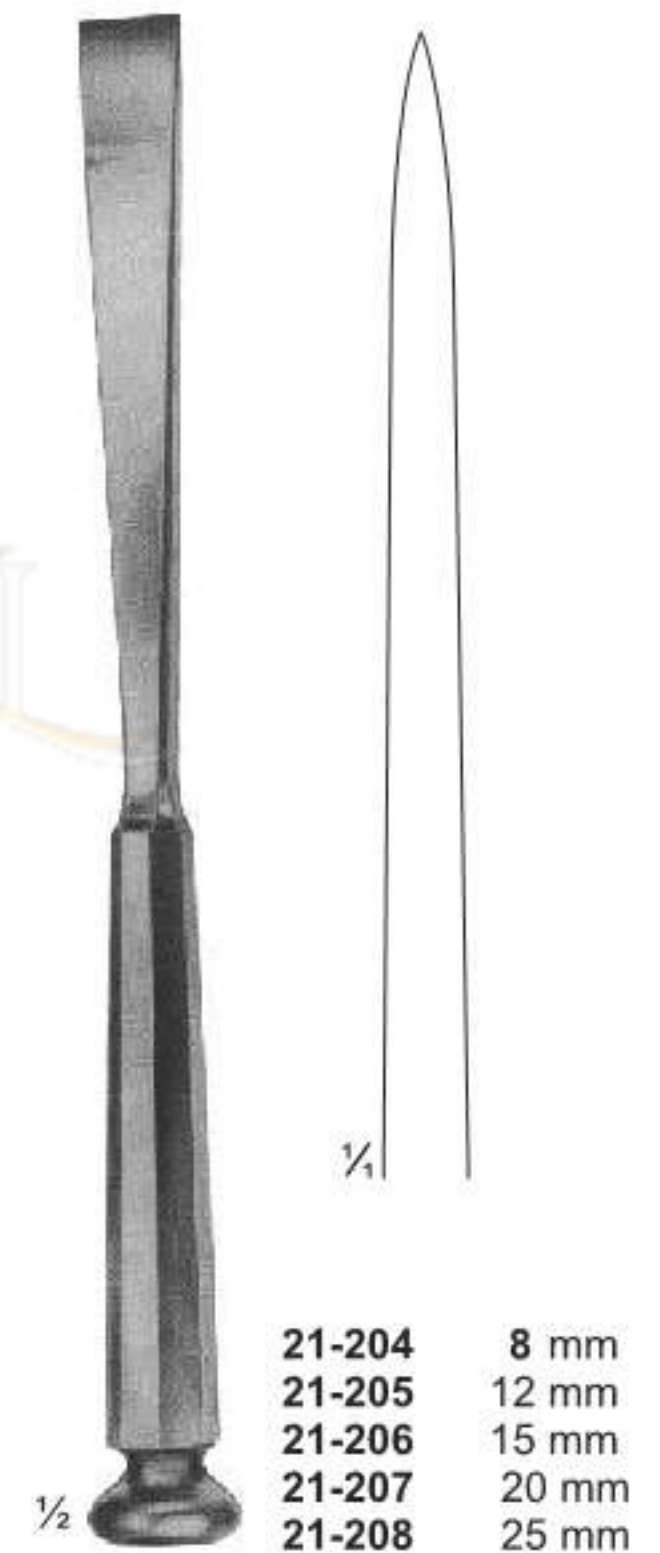

**STILLE**  
21-204 - 208  
Osteotomes  
205 mm

- |        |       |
|--------|-------|
| 21-204 | 8 mm  |
| 21-205 | 12 mm |
| 21-206 | 15 mm |
| 21-207 | 20 mm |
| 21-208 | 25 mm |

# Osteotomes



**STILLE**  
**21-209 - 213**  
 Osteotomes  
 205 mm

**STILLE**  
**21-214 - 218**  
 Osteotomes, curved  
 205 mm

**LAMBOTTE**  
**21-219 - 230**  
 Osteotomes  
 245 mm

**LAMBOTTE**  
**21-231 - 236**  
 Osteotomes, curved  
 245 mm

# Osteotomes, Chisels and Gouges with HARTPRESS -handle

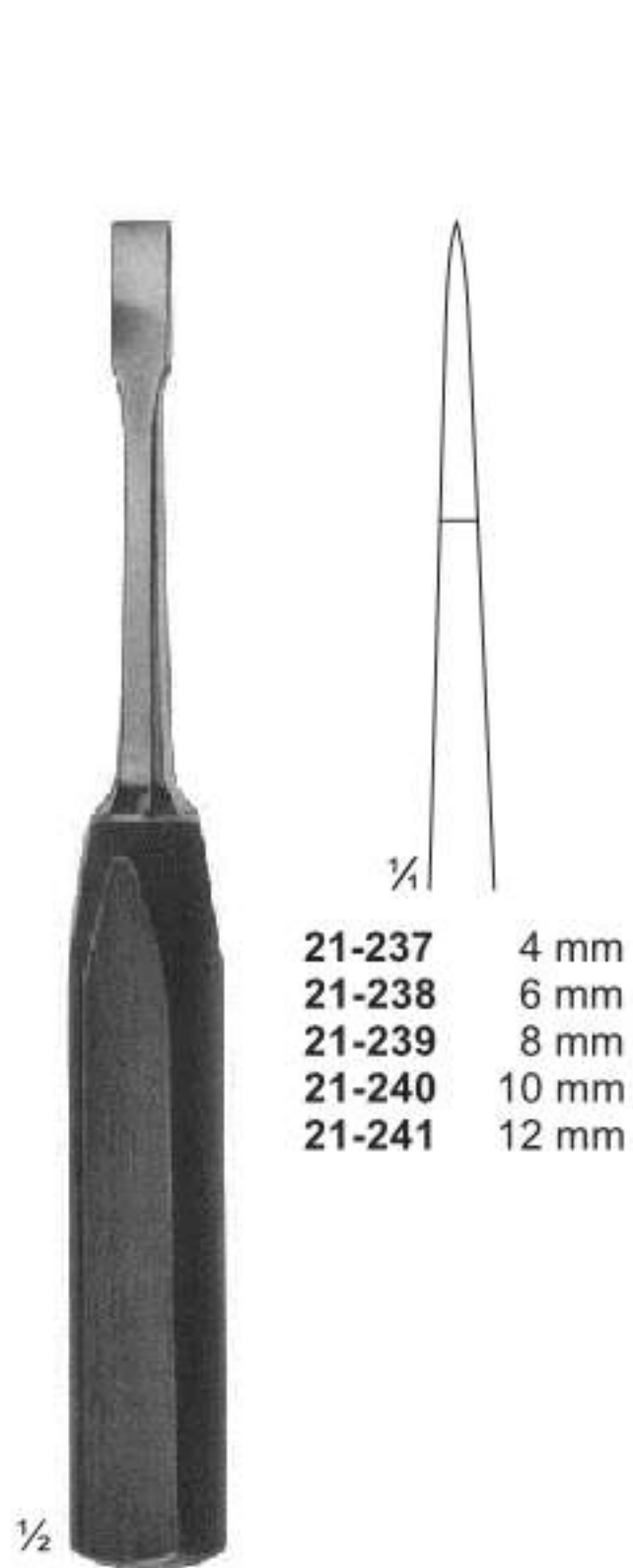

- 21-237 4 mm
- 21-238 6 mm
- 21-239 8 mm
- 21-240 10 mm
- 21-241 12 mm

**LEXER-MINI**  
21-237 - 241  
Osteotomes  
180 mm

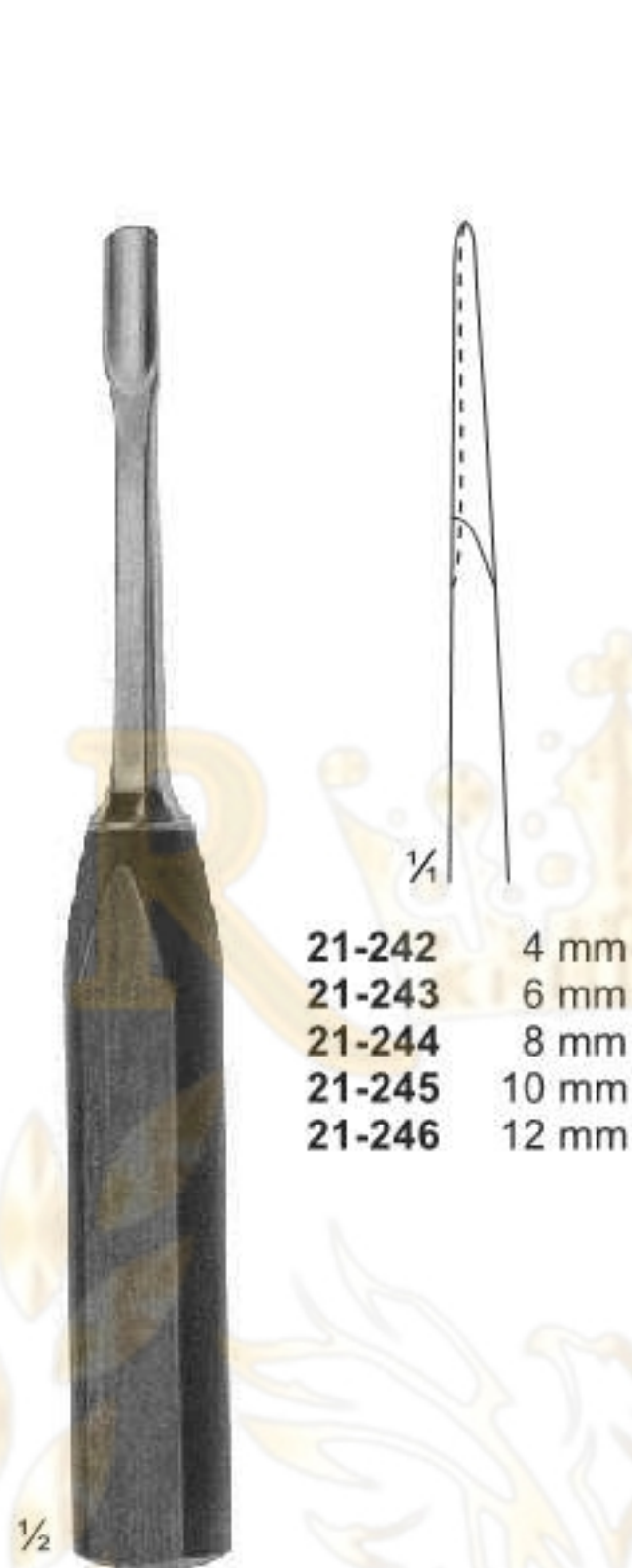

- 21-242 4 mm
- 21-243 6 mm
- 21-244 8 mm
- 21-245 10 mm
- 21-246 12 mm

**LEXER-MINI**  
21-242 - 246  
Gouges  
180 mm

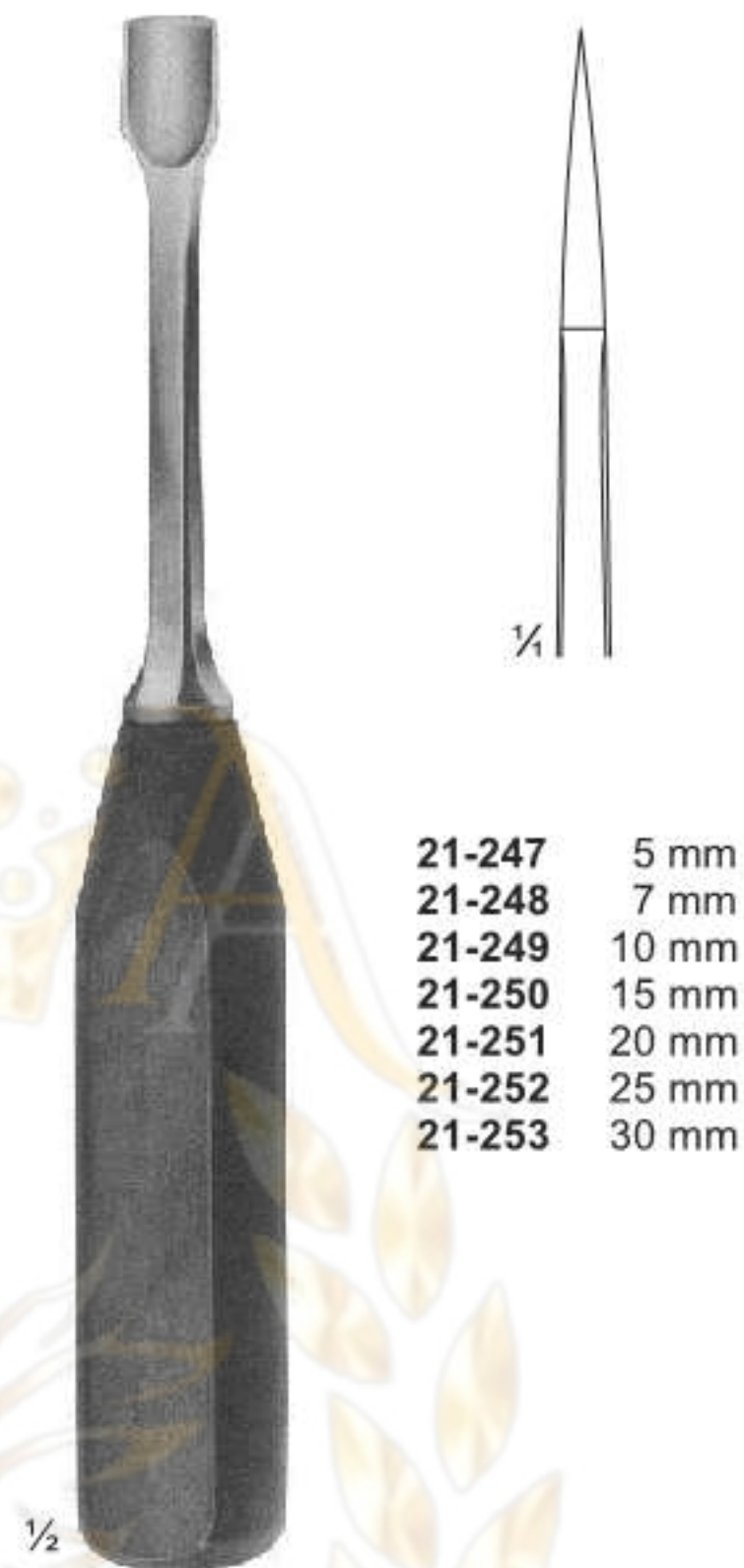

- 21-247 5 mm
- 21-248 7 mm
- 21-249 10 mm
- 21-250 15 mm
- 21-251 20 mm
- 21-252 25 mm
- 21-253 30 mm

**LEXER**  
21-247 - 253  
Osteotomes  
220 mm

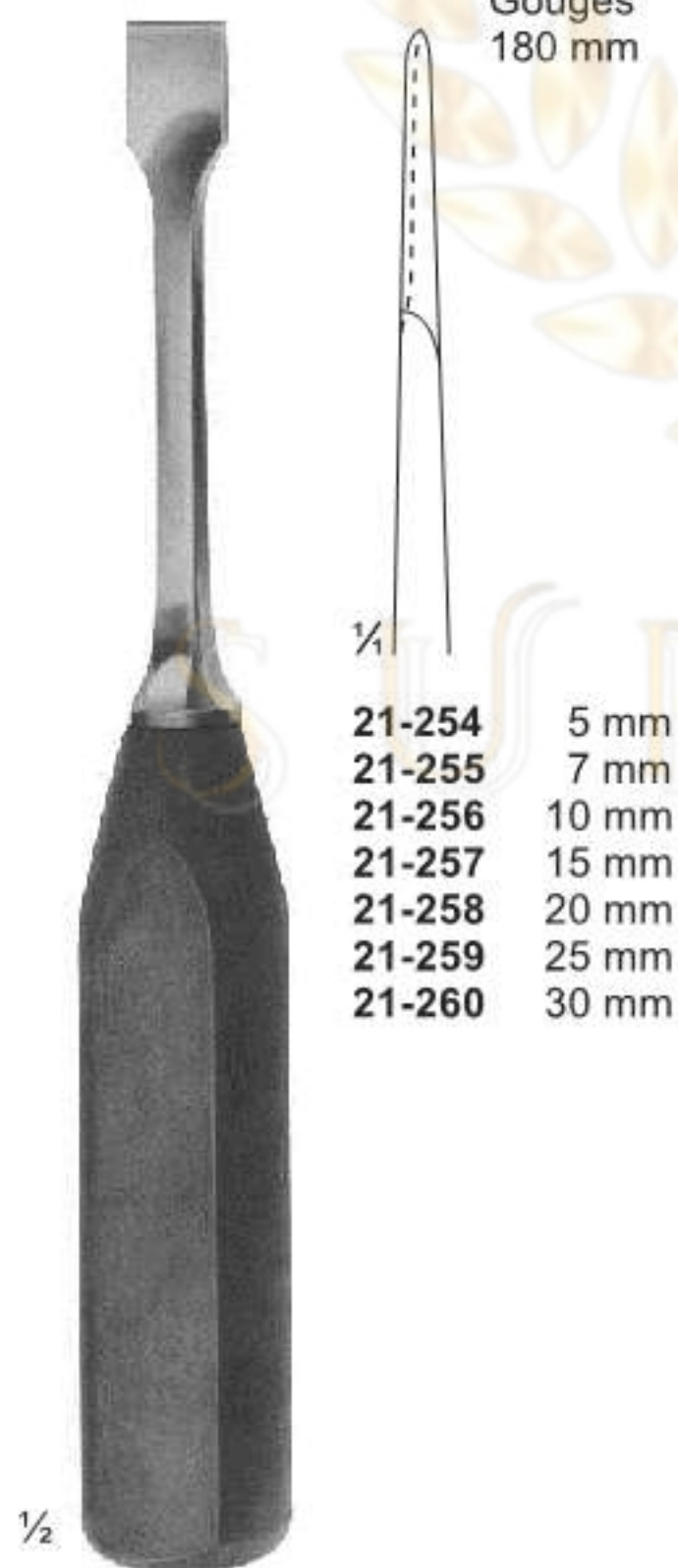

- 21-254 5 mm
- 21-255 7 mm
- 21-256 10 mm
- 21-257 15 mm
- 21-258 20 mm
- 21-259 25 mm
- 21-260 30 mm

**LEXER**  
21-254 - 260  
Gouges  
220 mm



**LEXER**  
21-261  
Gouge for  
removing broken  
screws  
220 mm

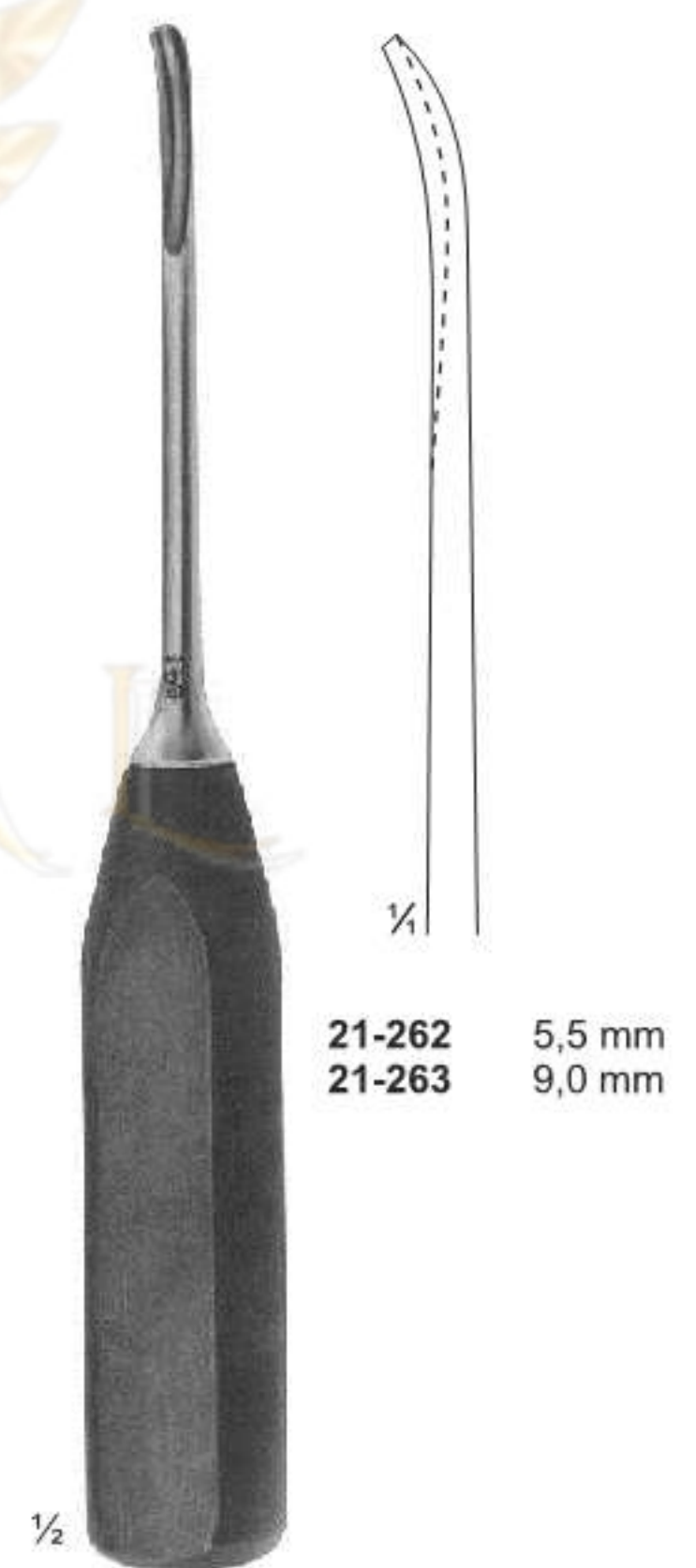

- 21-262 5,5 mm
- 21-263 9,0 mm

**ZIELKE**  
21-262 - 263  
Gouge for  
scoliose-operations  
230 mm

# Osteotomes ,Chisels and Gouges with HARTPRESS -handle



21-264 10 mm  
21-265 15 mm

LEXER  
21-264 - 265  
Osteotomes,  
angled  
275 mm



21-266 10 mm  
21-267 15 mm

LEXER  
21-266 - 267  
Gouges,  
angled  
275 mm



20 mm

21-268  
Chisel  
245 mm



16 mm

21-269  
Chisel, curved  
265 mm

# Reposition Forceps

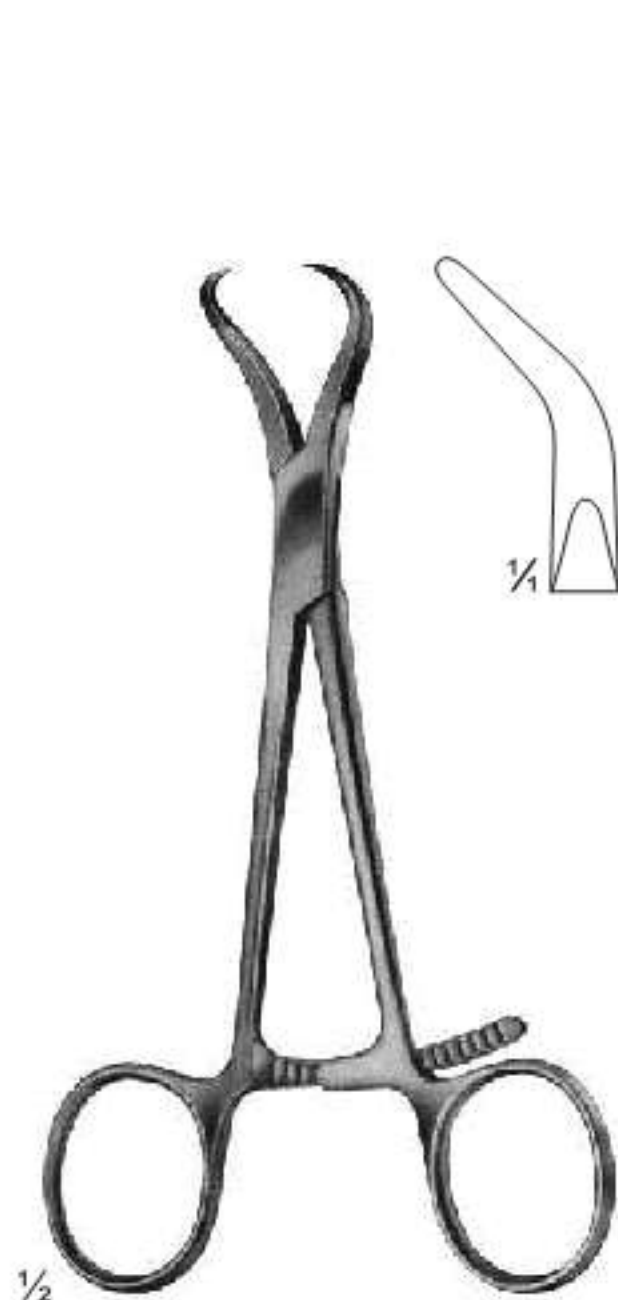

**22-101**  
Reposition forceps,  
for small fragments  
135 mm



**HAASE**  
**22-102**  
Reposition forceps,  
for mandibular  
fractures  
165 mm



**REILL**  
**22-103**  
Reposition forceps,  
170 mm



**22-104**  
Reposition forceps  
205 mm

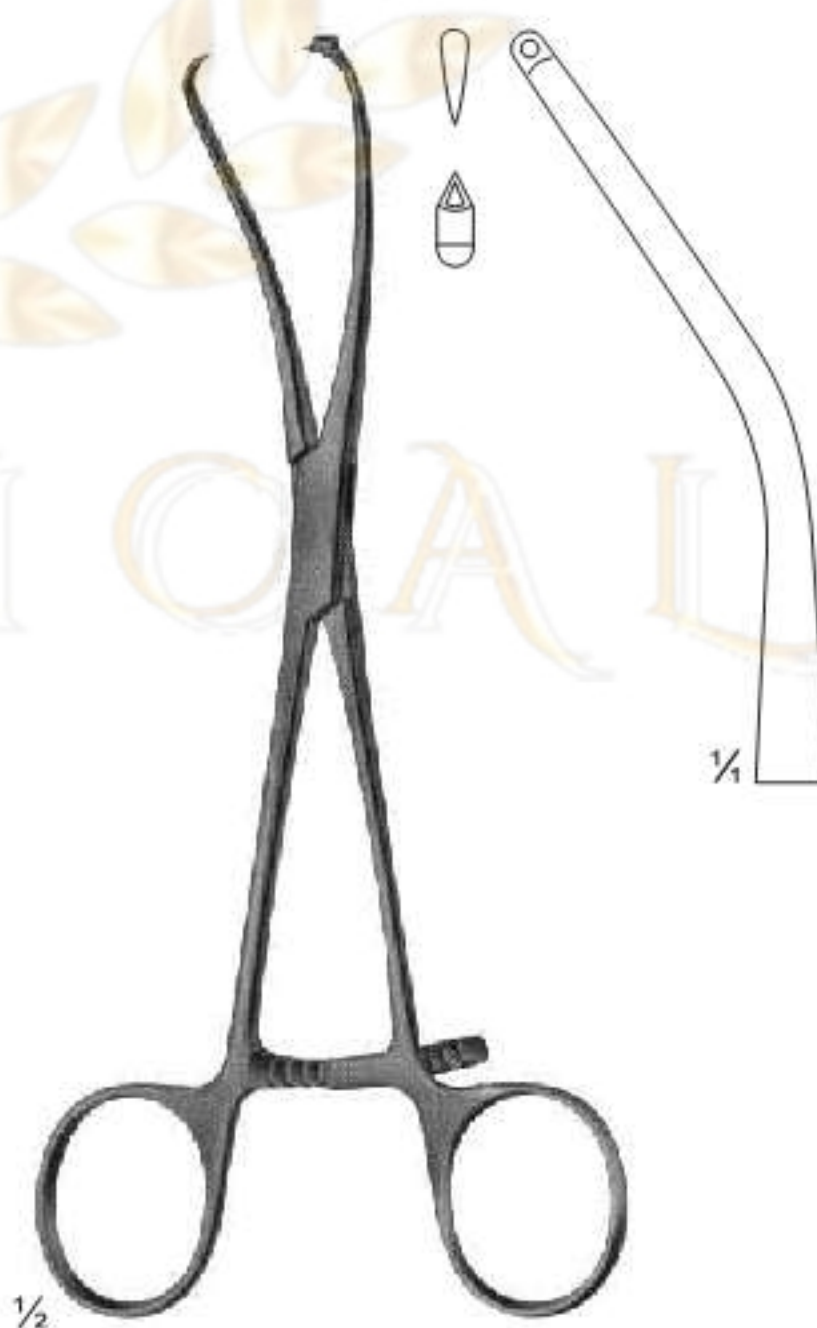

**MEYER**  
**22-105**  
Reposition forceps  
for fingers, with drill  
guide for KIRSCHNER  
wires up to daim.1.0 mm  
170 mm

# Reposition Forceps, Bone Holding Forceps



**22-106**  
Patella forceps  
185 mm



**22-107**  
Forceps with  
ratchet fixation  
140 mm



**22-108**  
Forceps with  
thread fixation  
170 mm



**22-109**  
Forceps with  
thread fixation  
235 mm

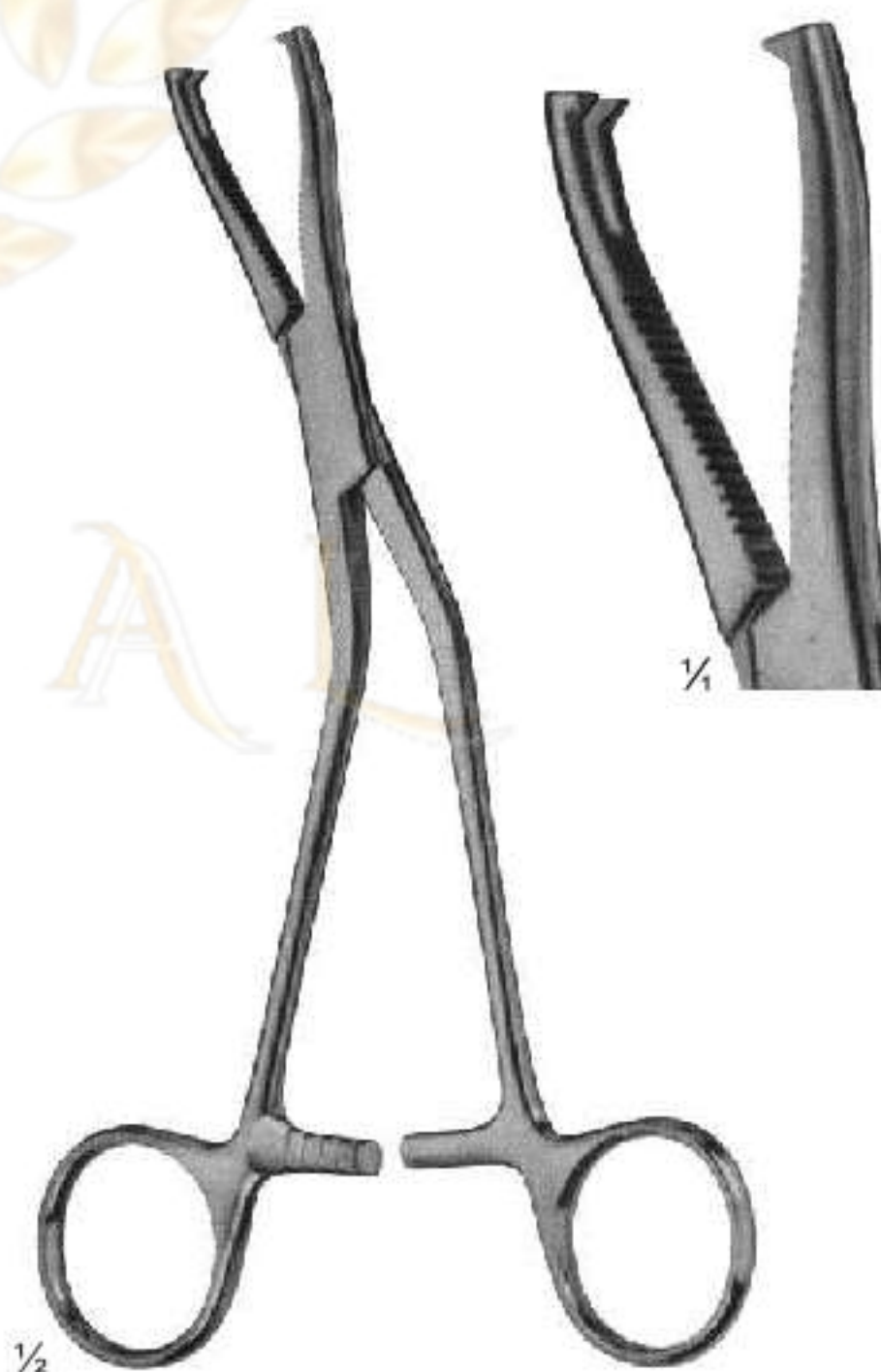

**22-110**  
DINGMANN  
185 mm

# Bone Holding Forceps

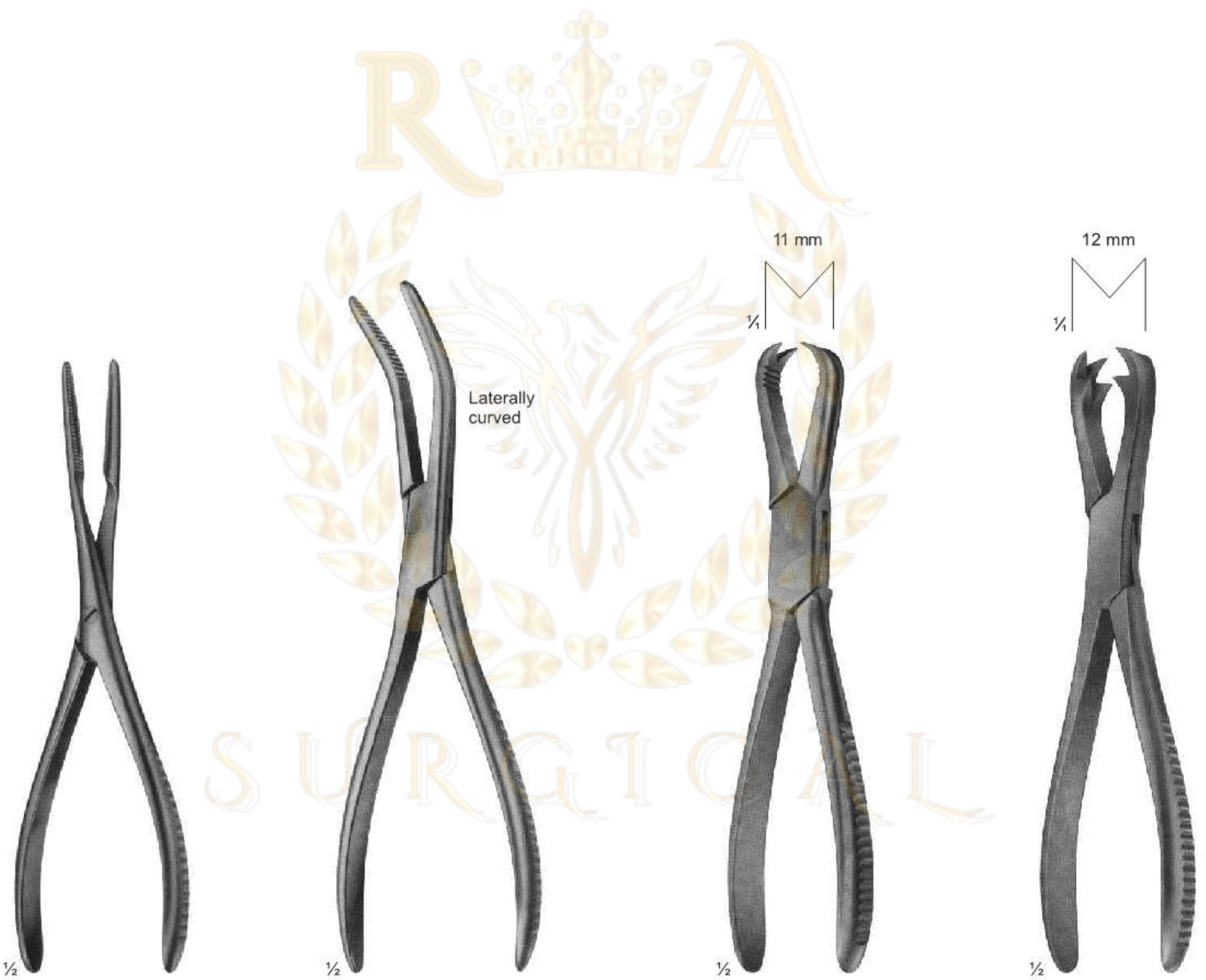

**22-111**  
Sequestrum  
forceps  
200 mm

**22-112**  
VAN BUREN  
Sequestrum  
forceps  
225 mm

**22-113**  
LANGENBECK  
Sequestrum  
forceps  
205 mm

**22-114**  
FERGUSON  
205 mm

# Bone Holding Forceps

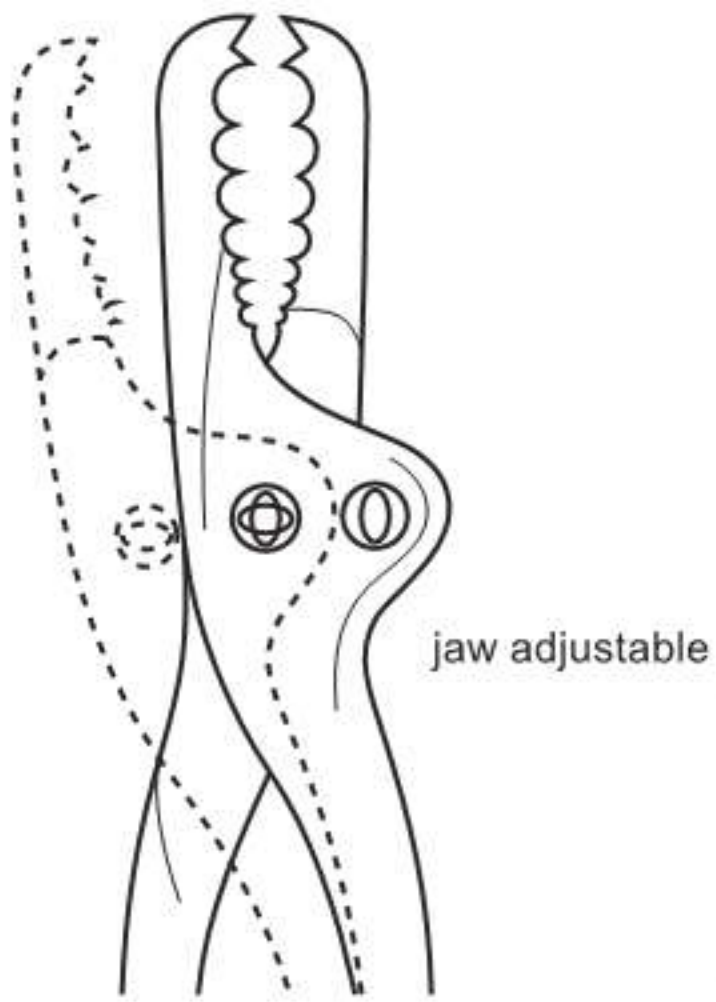

**22-115**  
SEMB  
190 mm

**22-116**  
FARABEUF  
230 mm

**22-117**  
FARABEUF  
255 mm

**22-118**  
FARABEUF-LAMBOTTE  
255 mm



# Bone Holding Forceps

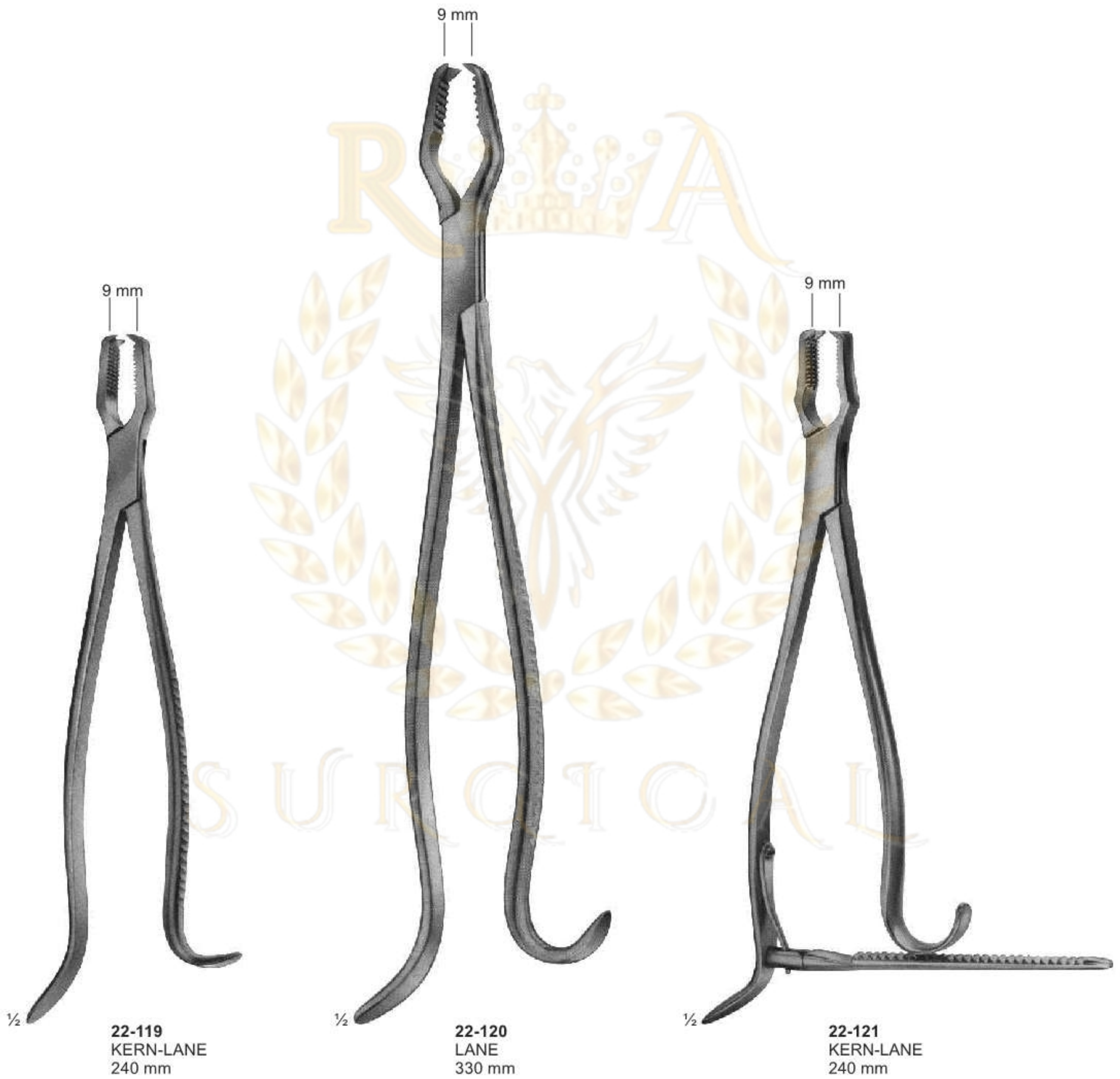

# Bone Holding Forceps



# Bone Holding Forceps

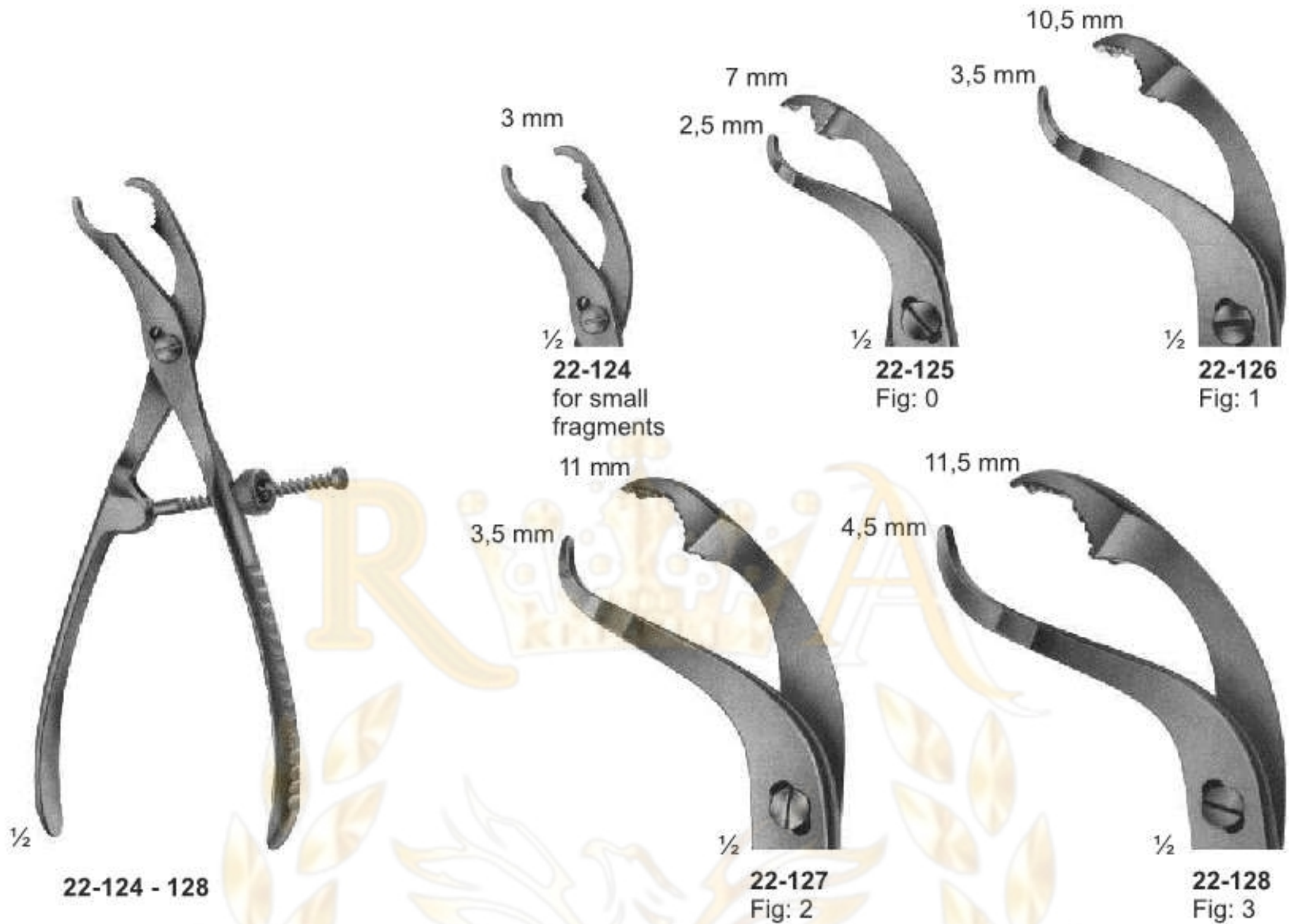

**22-124 - 128**

- 22-124 145 mm
- 22-125 190 mm
- 22-126 240 mm
- 22-127 260 mm
- 22-128 280 mm

Self-centering forceps  
with thread fixation



**22-129 - 131**  
VERBRUGGE  
with lip joint  
255 mm  
265 mm  
270 mm

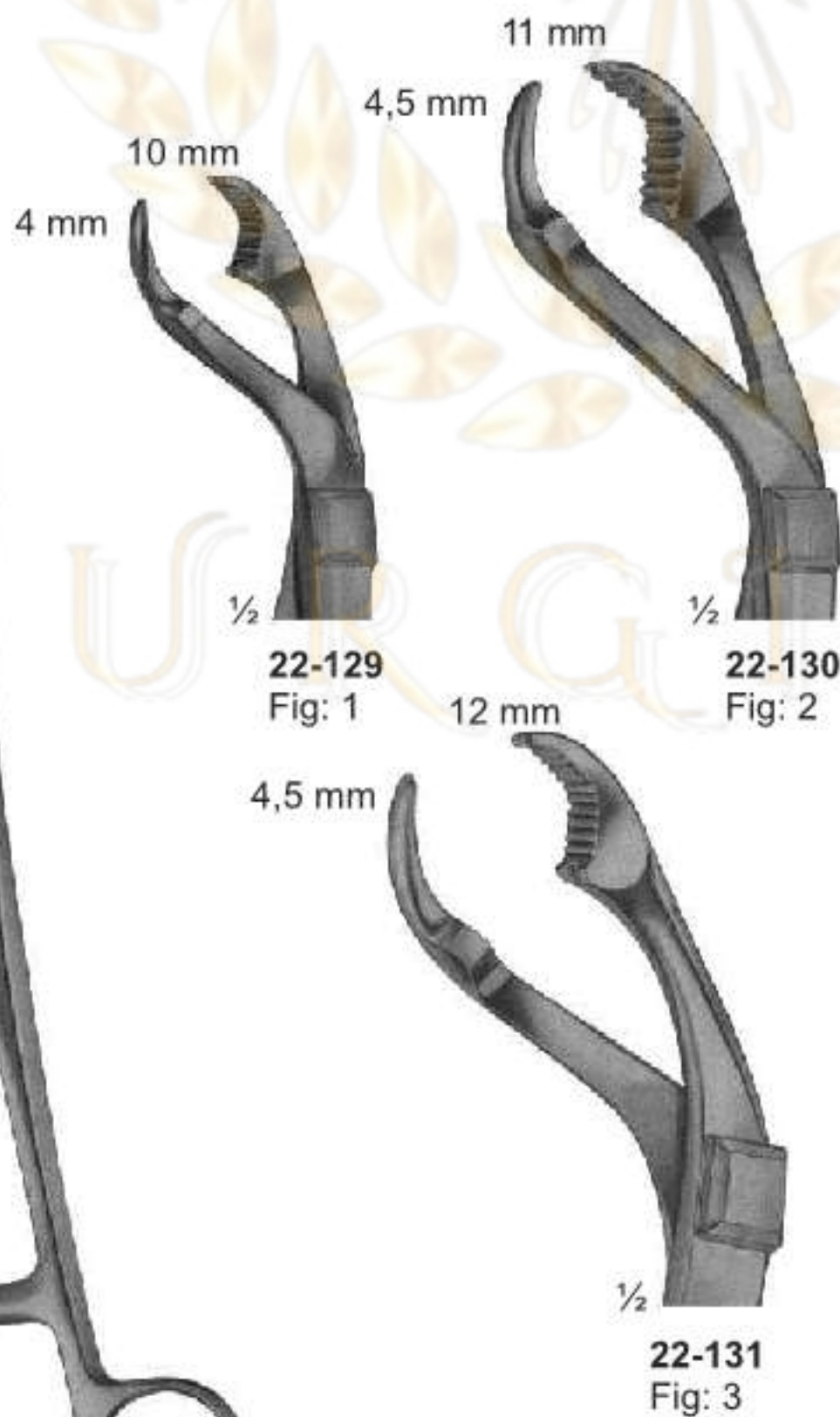

**22-129**  
Fig: 1

**22-130**  
Fig: 2

**22-131**  
Fig: 3



**22-132**  
LAMBOTTE  
265 mm

# Bone Clamps



$\frac{1}{2}$   
**22-133 - 134**  
LOWMAN  
22-133 170 mm  
22-134 205 mm



$\frac{1}{2}$   
**22-135**  
LOWMAN-GERSTER  
210 mm



$\frac{1}{2}$   
**22-136**  
LOWMAN-HOGLUND  
175 mm

# Synovectomy-Rongeurs, Bone Rongeurs

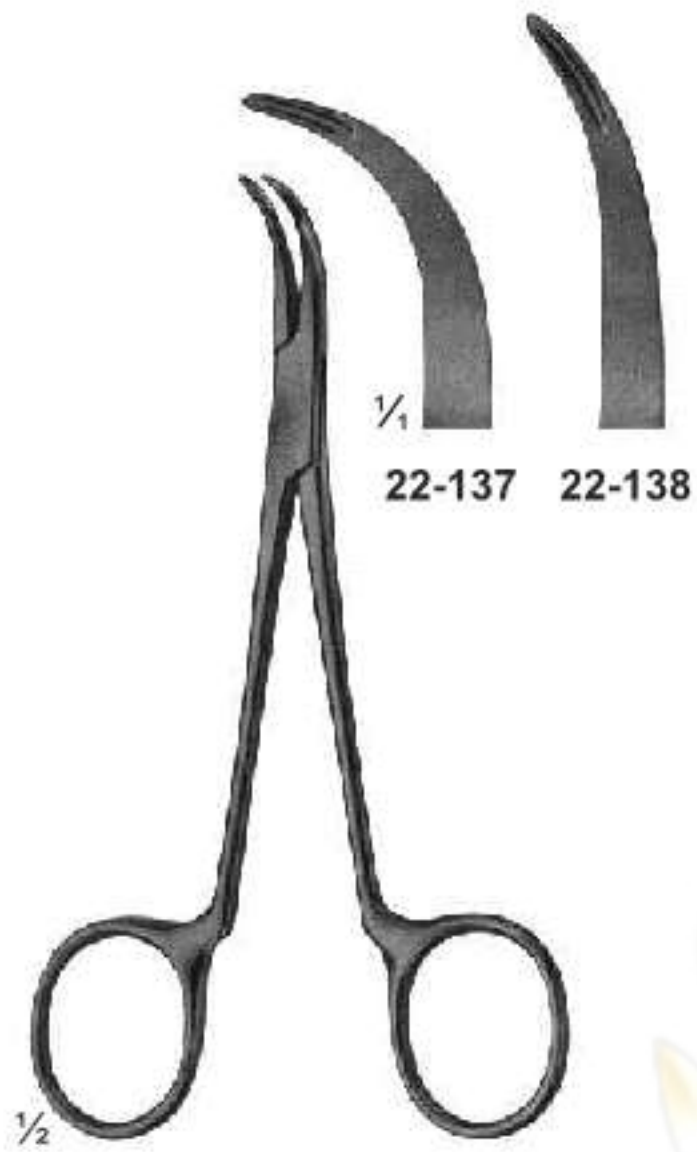

**22-137 - 138**  
Synovectomy rongeur  
width of jaws 1.2 mm  
130 mm



**22-139 - 140**  
Synovectomy rongeur  
width of jaws 2.0 mm  
130 mm

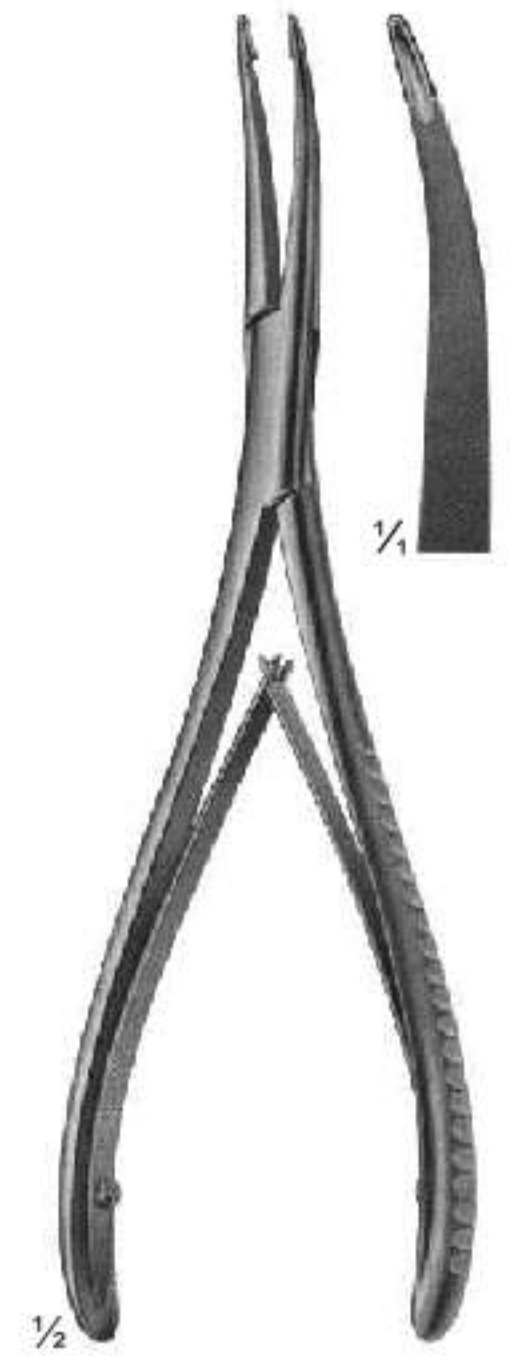

**22-141**  
STELLBRINK  
Synovectomy rongeur  
175 mm

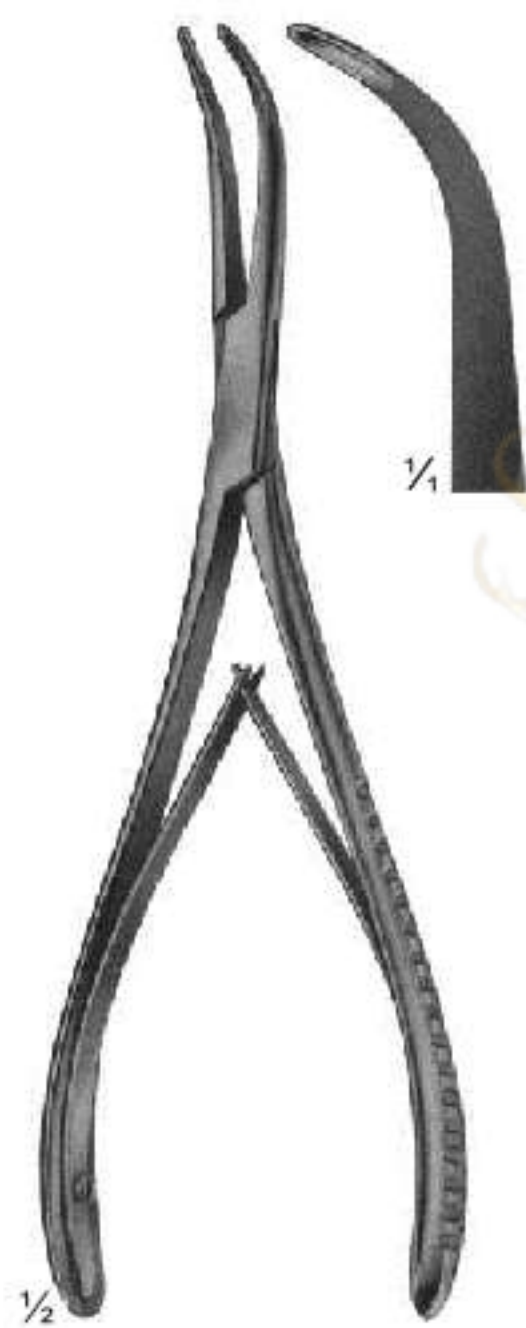

**22-142**  
STELLBRINK  
Synovectomy rongeur  
170 mm



**22-143**  
LURE-FRIEDMANN  
145 mm

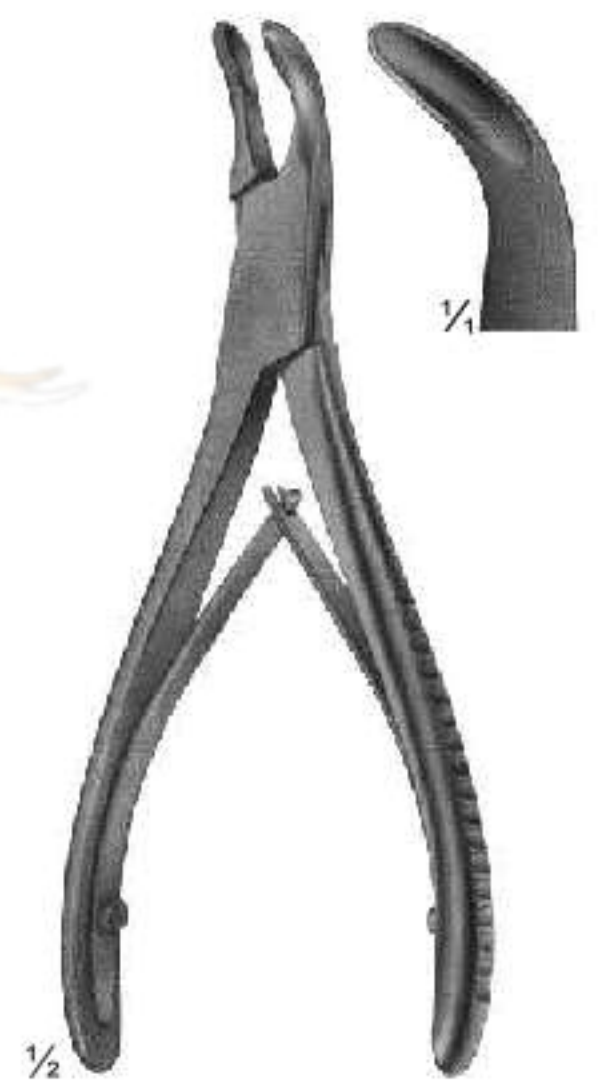

**22-144**  
140 mm

# Bone Rongeurs



**22-145**  
LURE  
150 mm



**22-146**  
LURE  
155 mm

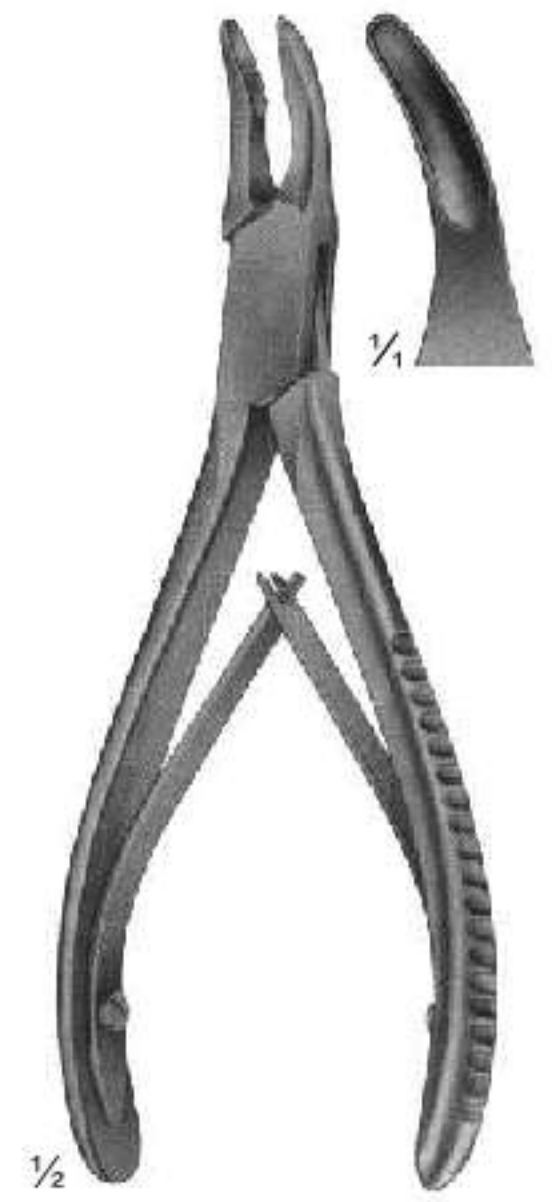

**22-147**  
BLUMENTHAL  
155 mm

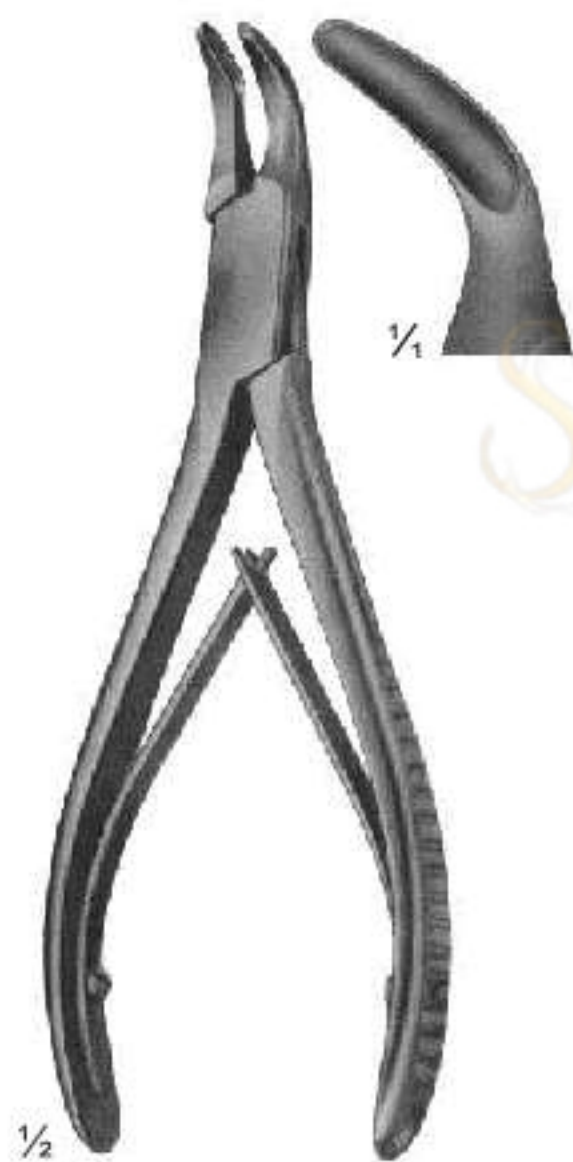

**22-148**  
BLUMENTHAL  
150 mm

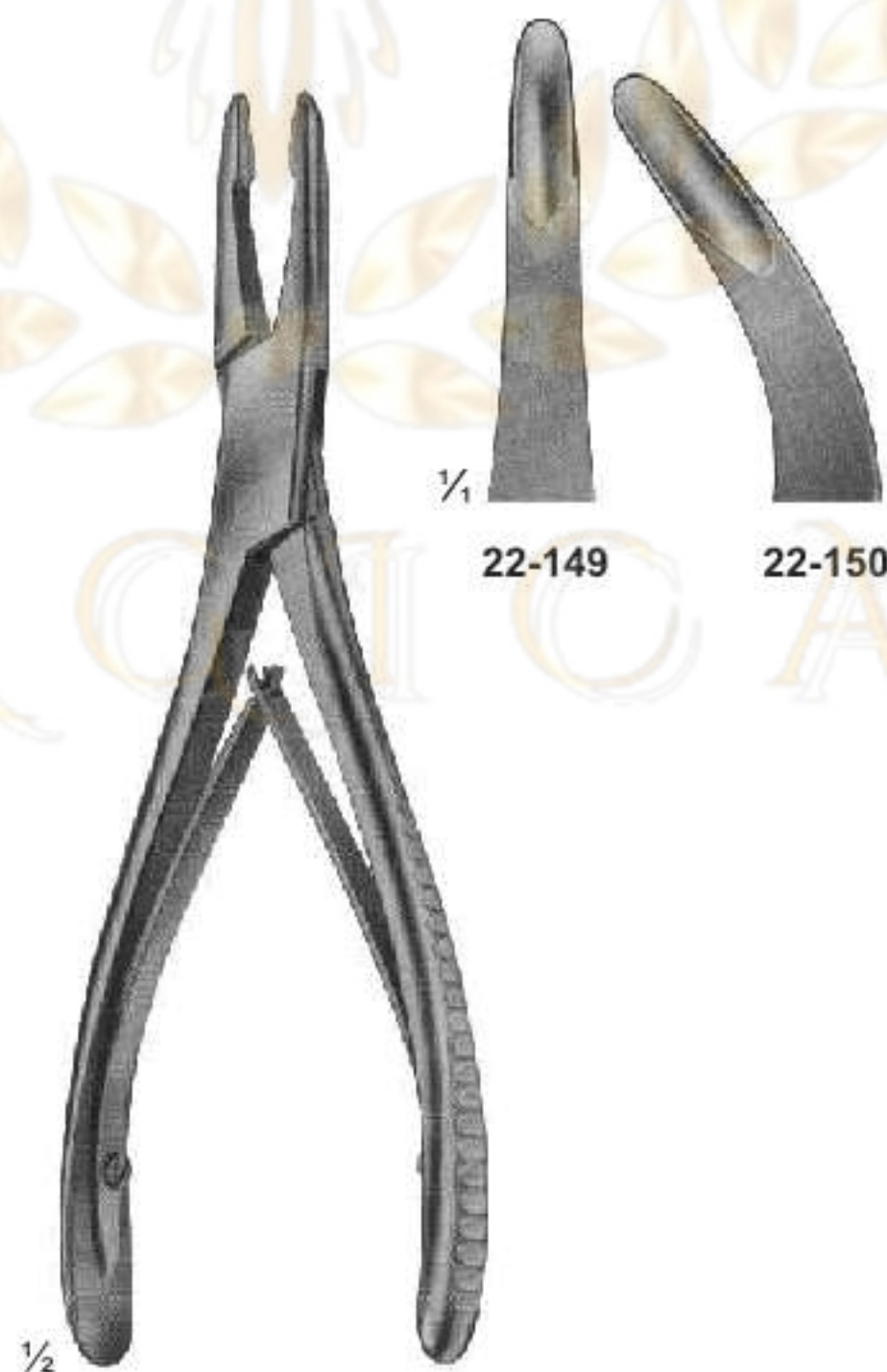

**22-149 - 150**  
JANSSEN  
175 mm

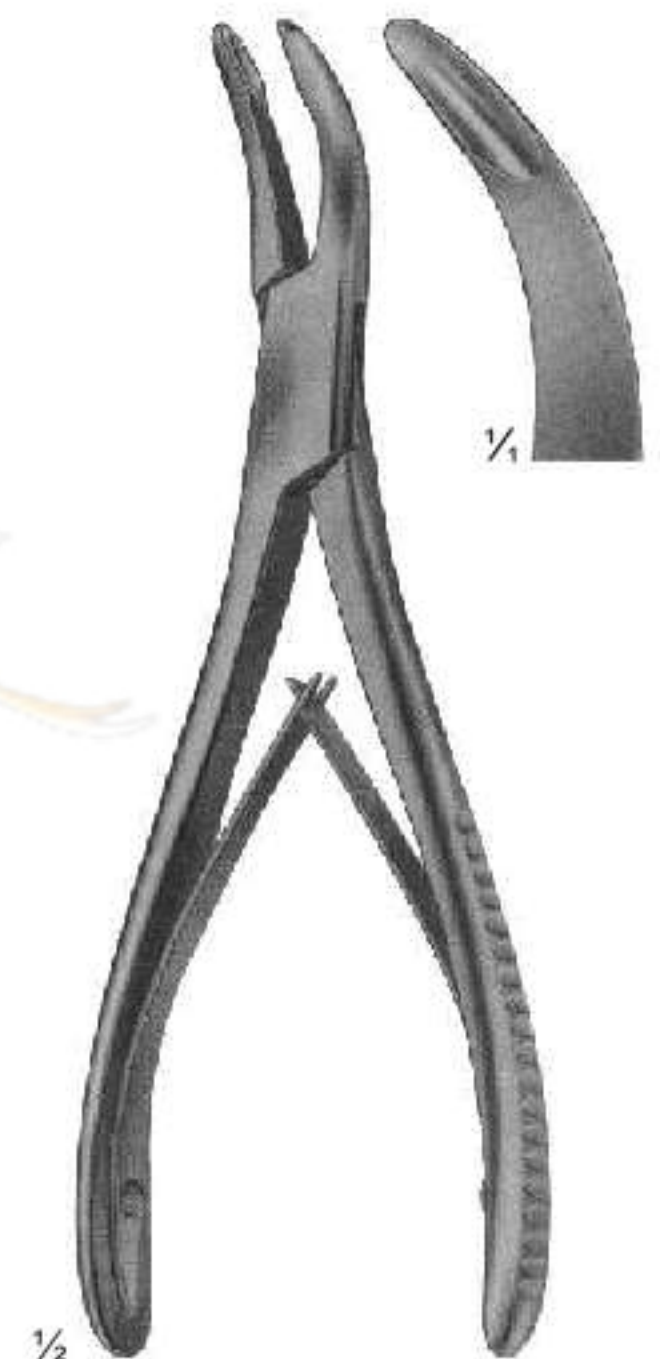

**22-151**  
BANE-HARTMANN  
175 mm

# Bone Rongeurs



**22-152**  
ALEXANDER  
140 mm

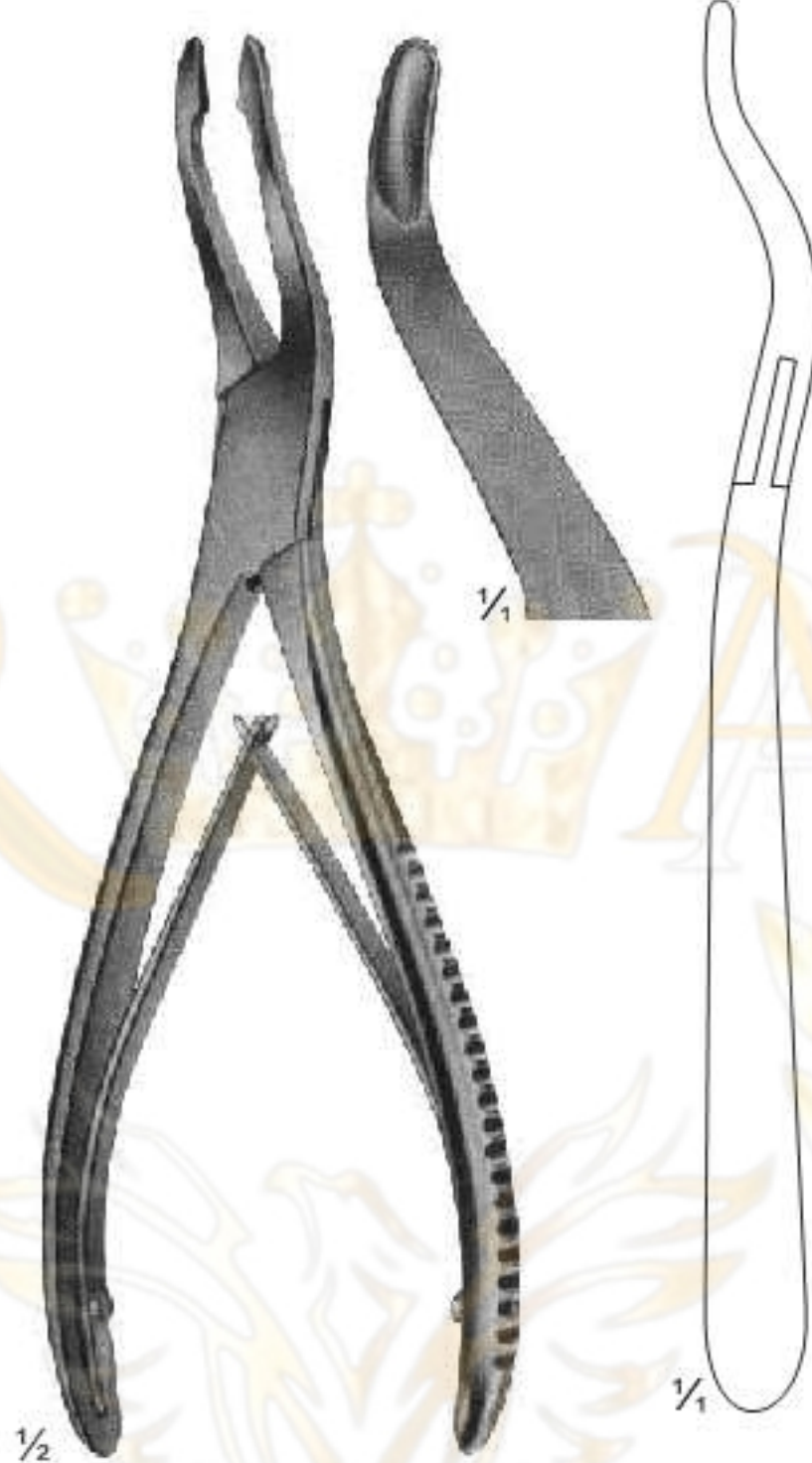

**22-153**  
JANSEN  
190 mm

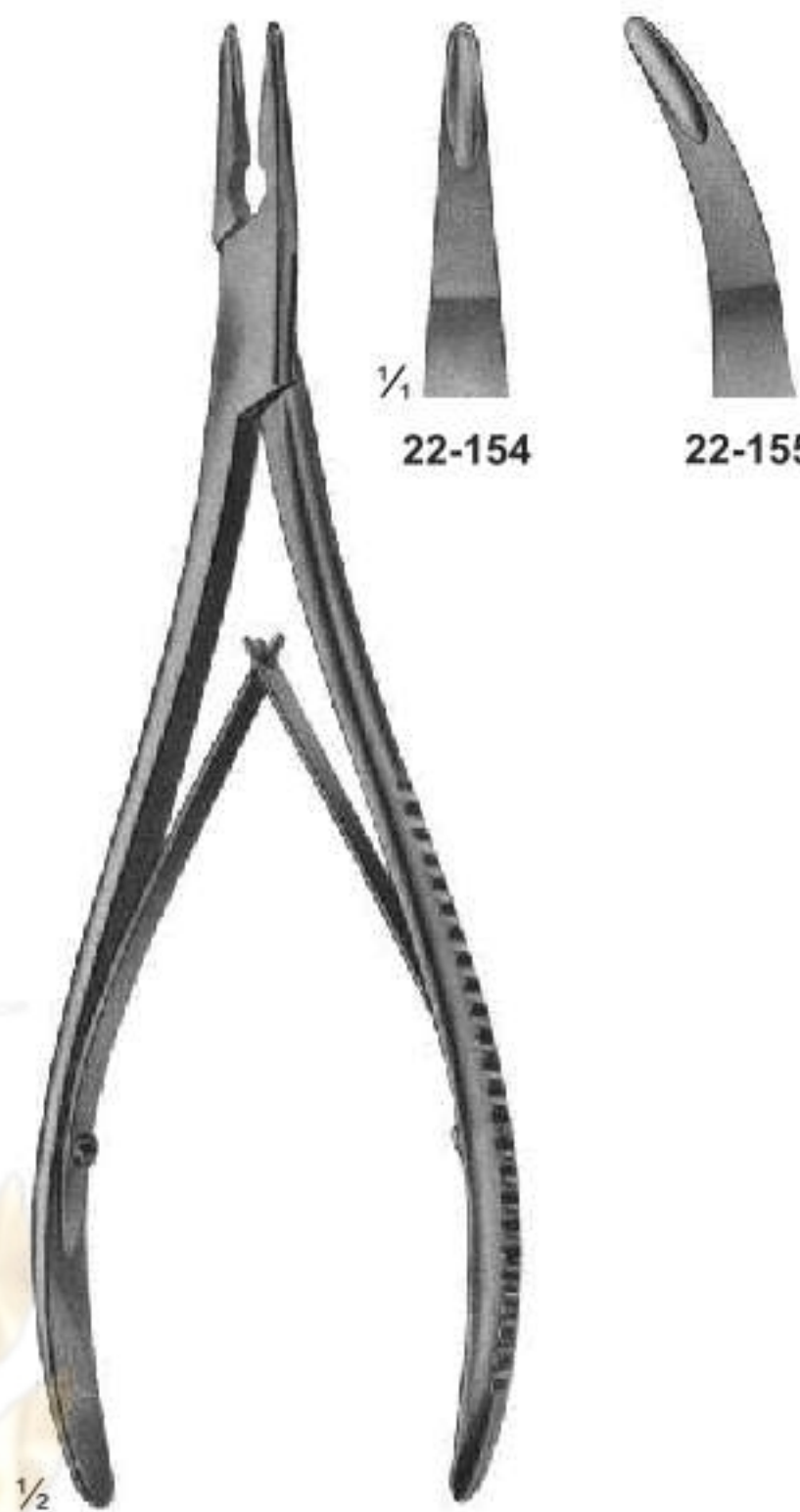

**22-154 - 155**  
LEMPERT  
200 mm

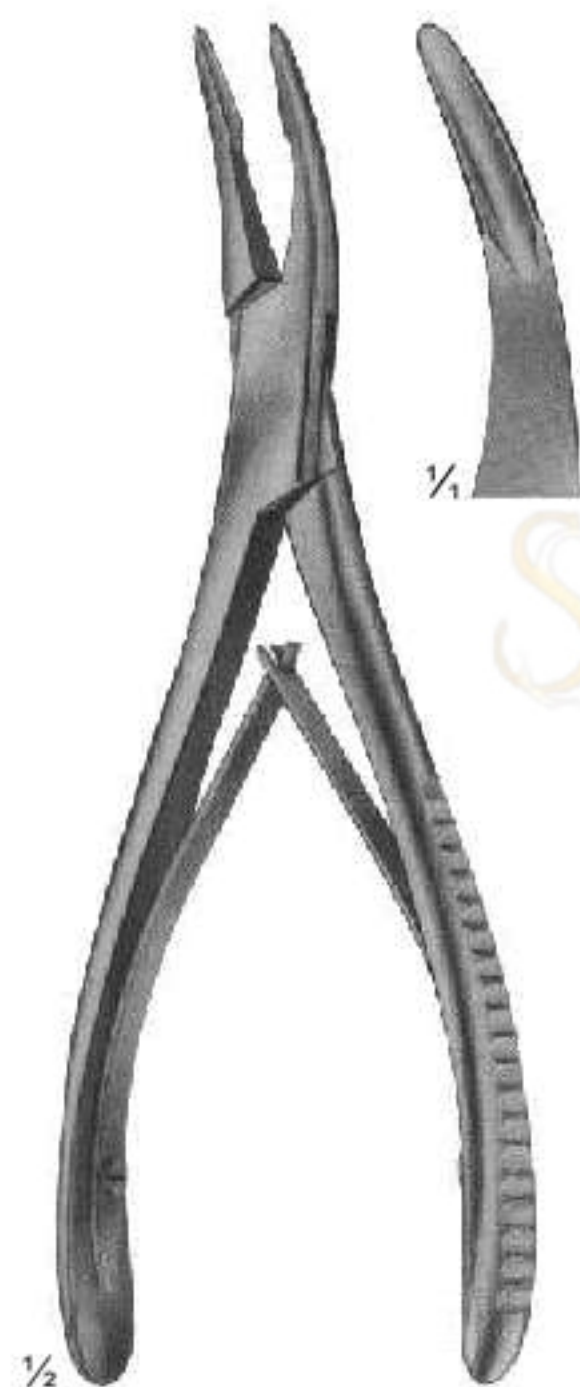

**22-156**  
BEYER  
180 mm

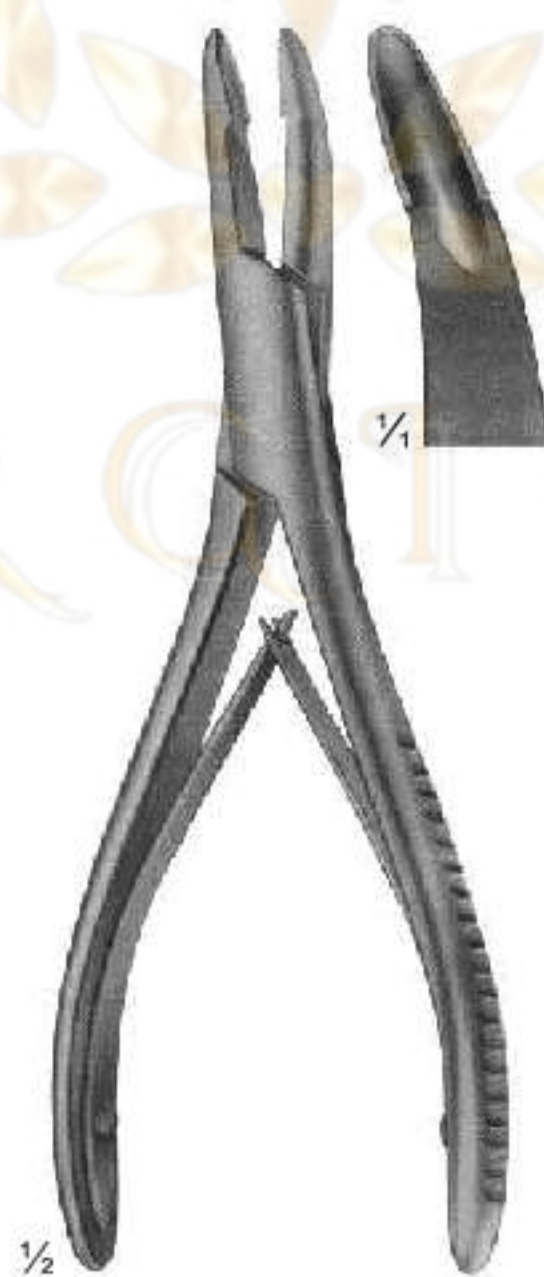

**22-157**  
MEAD  
165 mm

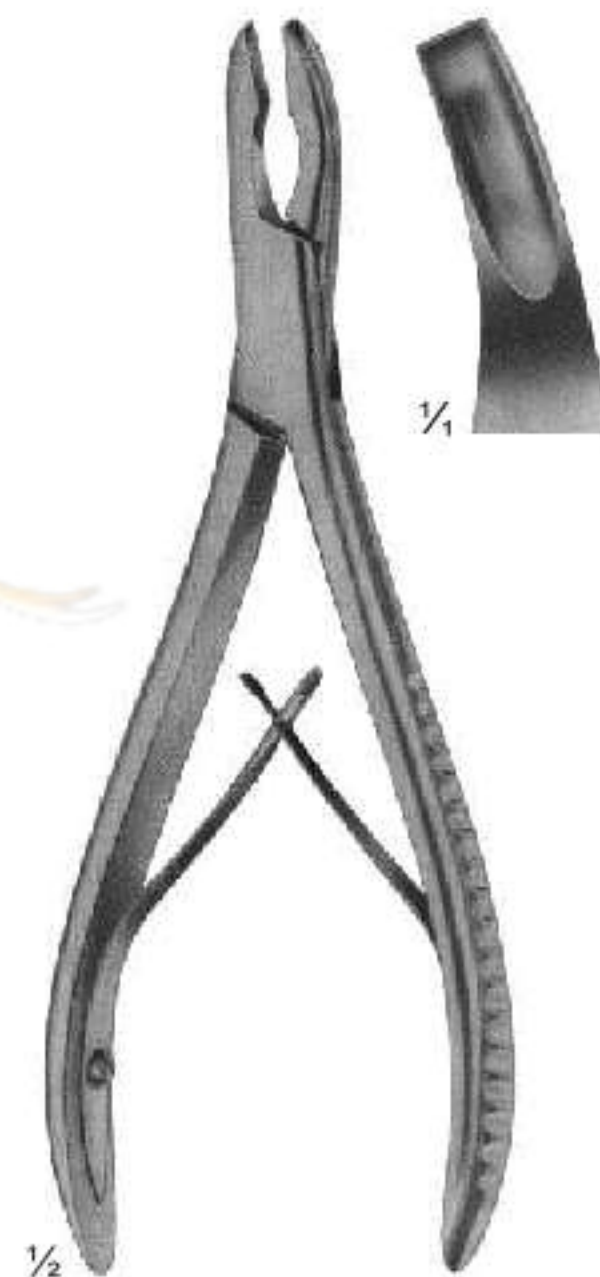

**22-158**  
MEAD  
165 mm

# Bone Rongeurs

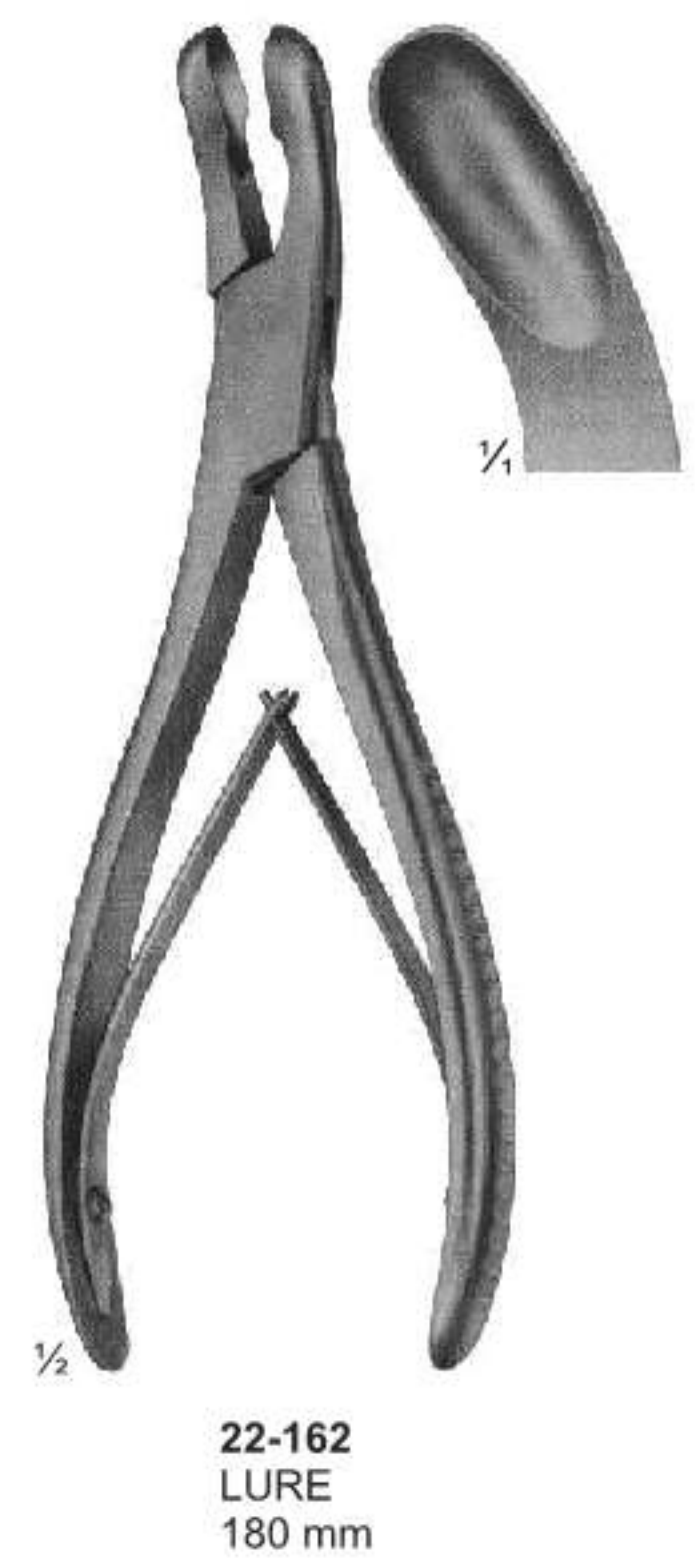
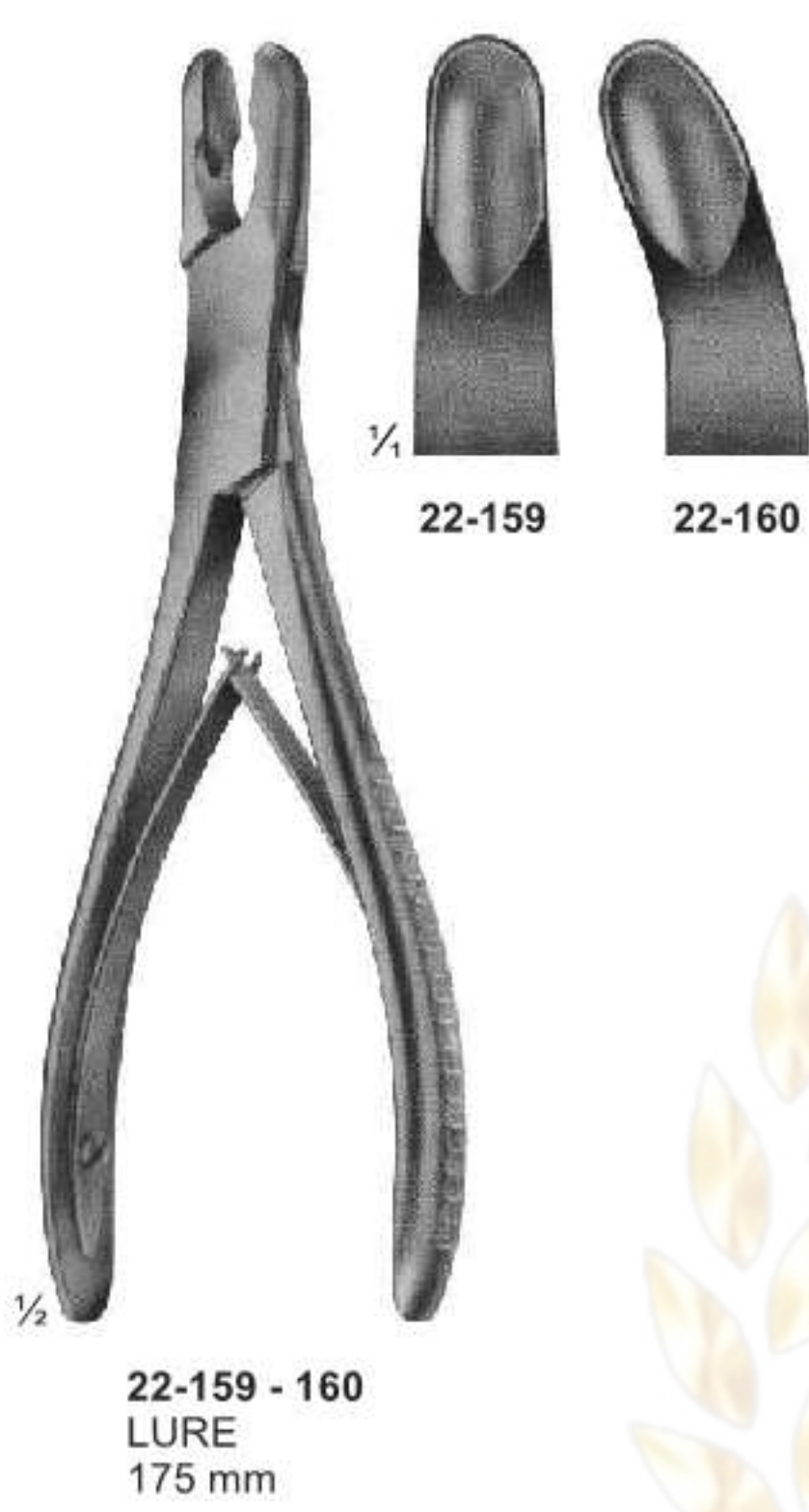



# Bone Rongeurs



# Bone Rongeurs



**22-171**  
STILLE  
235 mm



**22-172**  
LEKSELL-STILLE  
240mm



**22-173**  
STILLE-RUSKIN  
240mm



**22-174**  
LURE-STILLE  
225 mm

**22-175**  
LURE-STILLE  
225 mm

# Vena-Cava Clamps



# Bone Cutting Forceps

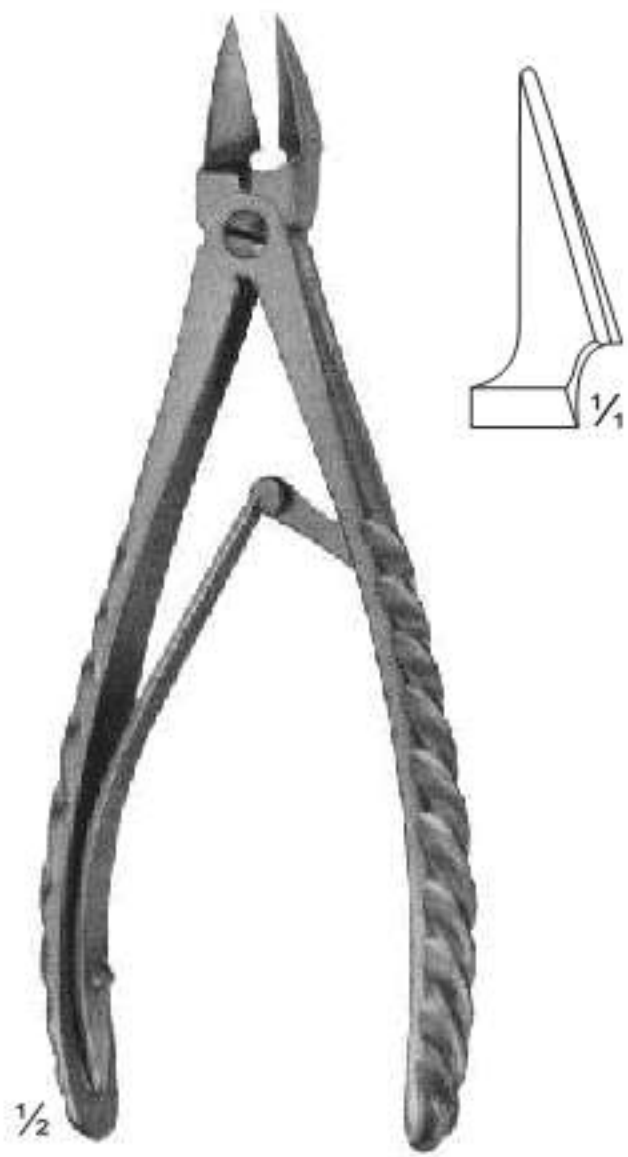

**22-178**  
STAMM  
150 mm



**22-179**  
KAZANJIAN  
185 mm



**22-180 - 183**  
LISTON

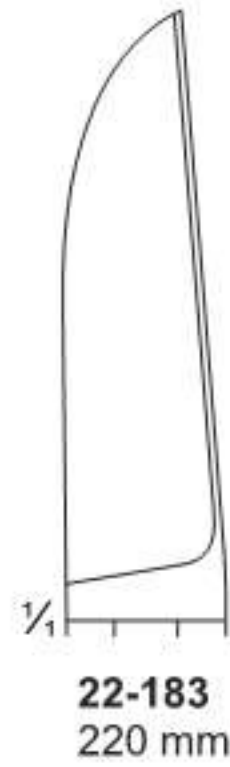

**22-184 - 186**  
LISTON

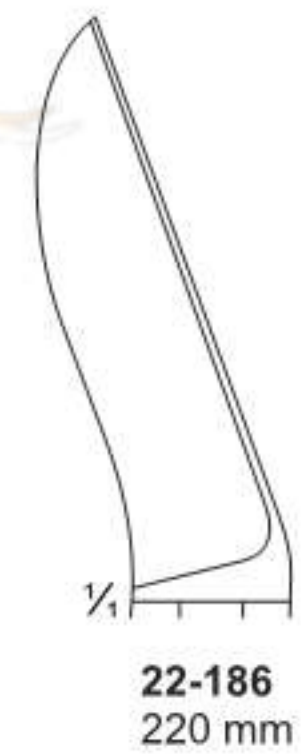

# Bone Cutting Forceps



**22-187**  
BOHLER  
145 mm



**22-188**  
RUSKIN-LISTON  
190 mm

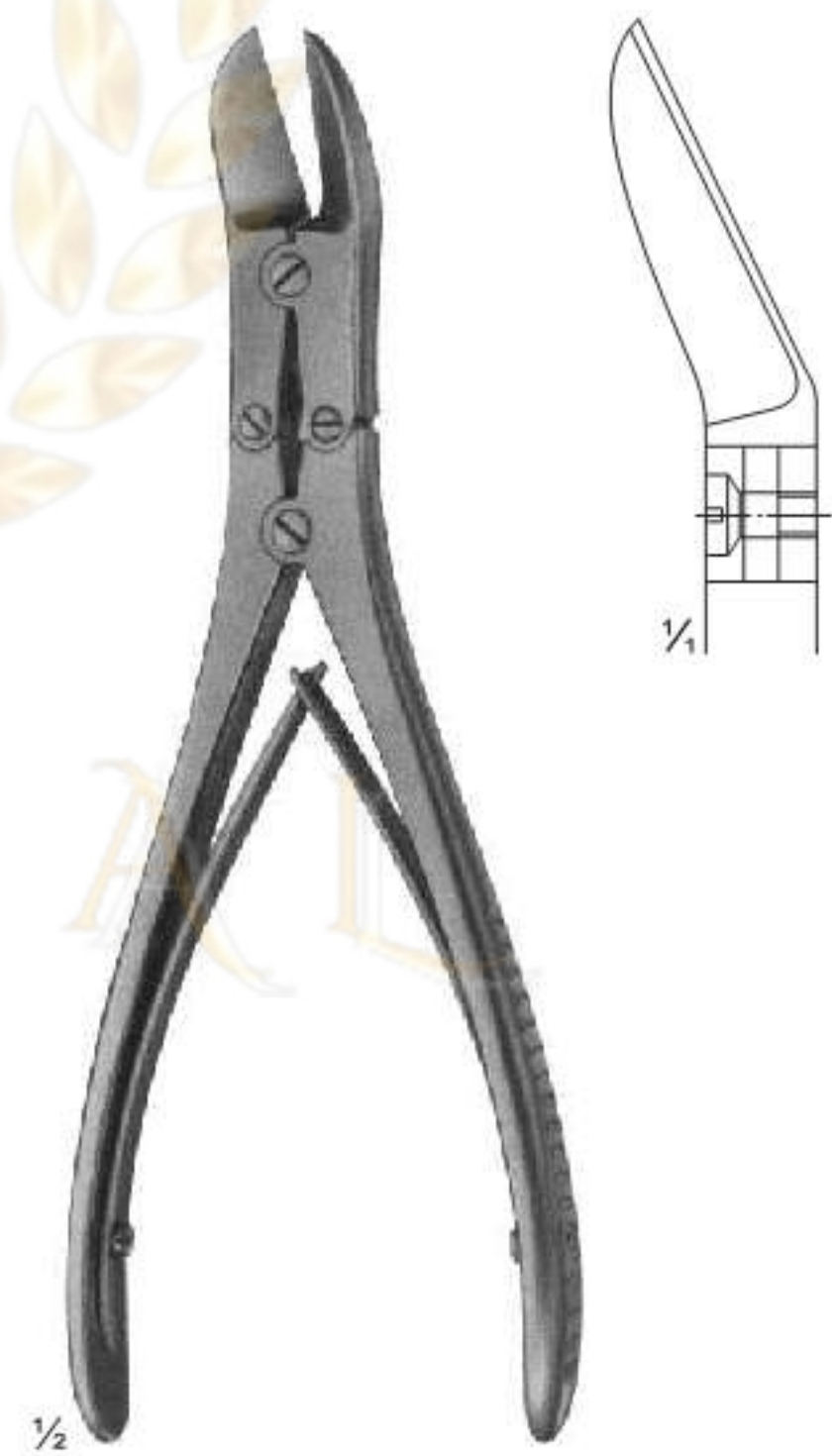

**22-189**  
RUSKIN-LISTON  
190 mm

# Bone Cutting Forceps

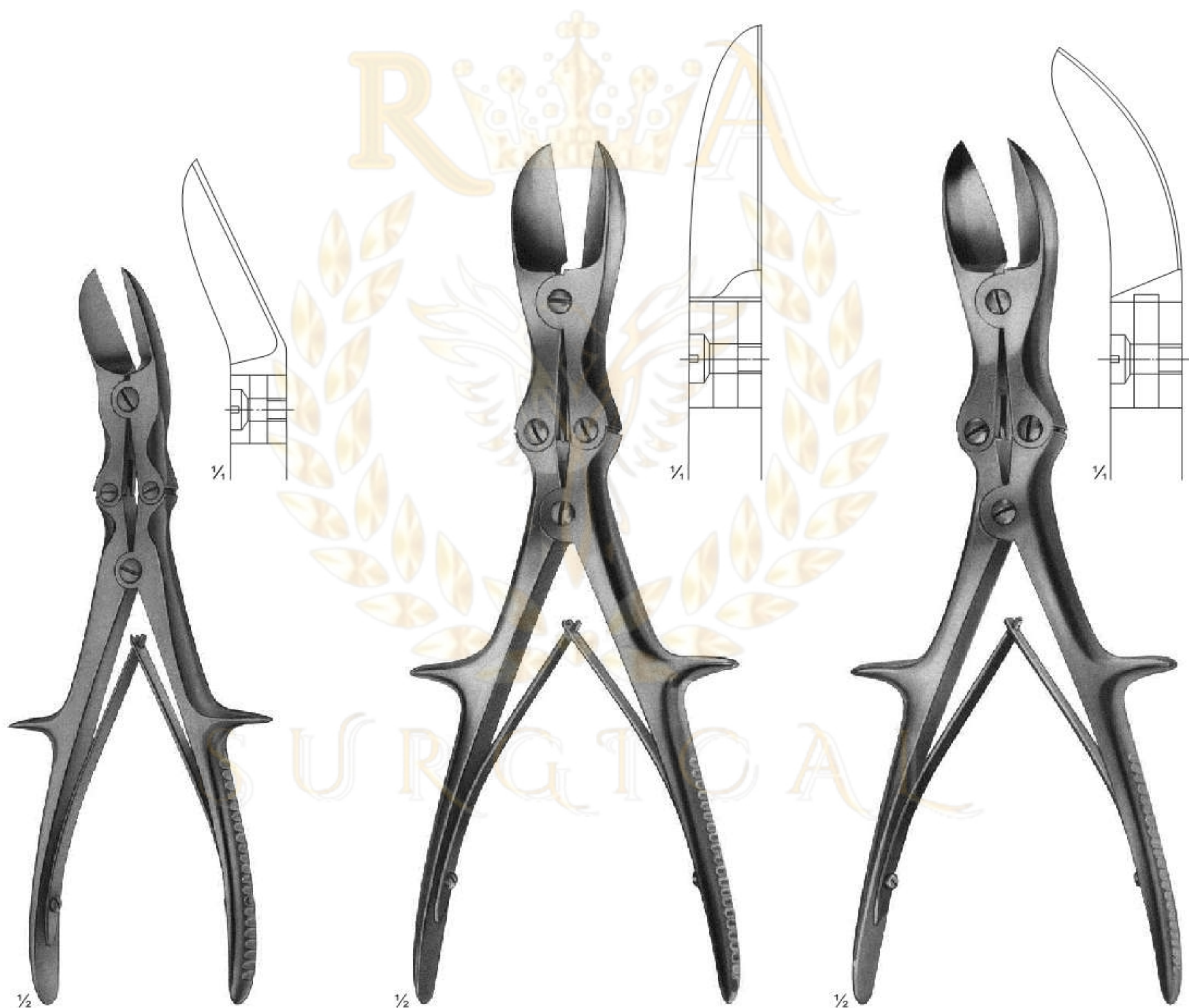

**22-190**  
LISTON  
curved on flat  
240 mm

**22-191**  
LISTON  
straight  
280 mm

**22-192**  
LISTON  
curved on flat  
280 mm

# Bone Cutting Forceps

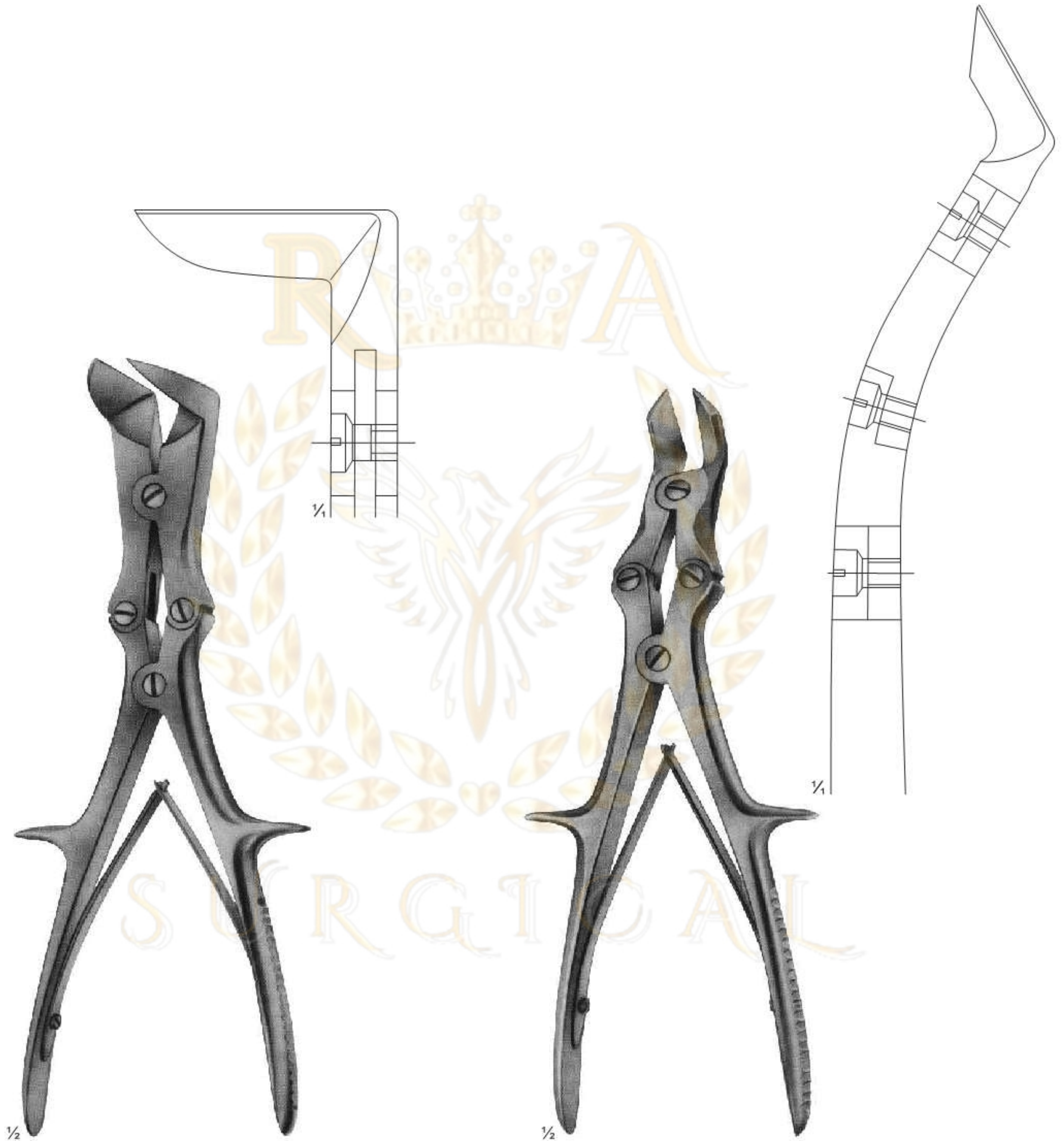

**22-193**  
LISTON-STILLE  
265 mm

**22-194**  
LISTON-KEY-HORSLEY  
(TUDOR EDWARDS)  
255 mm



# Meniscus-and Cartilage Forceps



**22-195**  
BIRCHER  
200 mm



**22-196**  
BIRCHER  
200 mm

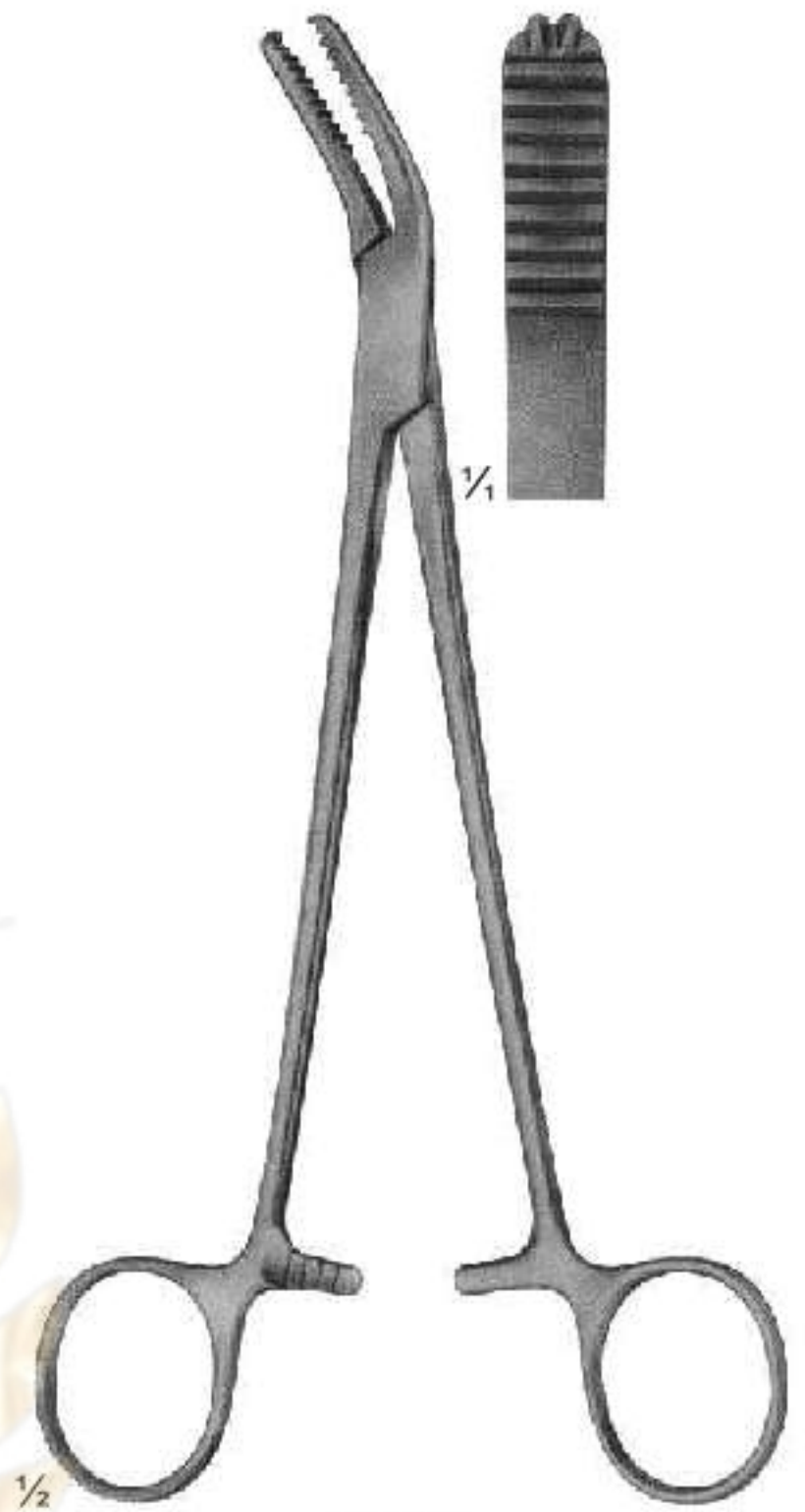

**22-197**  
WELLER  
200 mm



**22-198**  
BIRCHER-GANSKE  
200 mm



**22-199**  
BIRCHER-GANSKE  
200 mm



**22-200**  
MARTIN  
205 mm

# Meniscus Knives

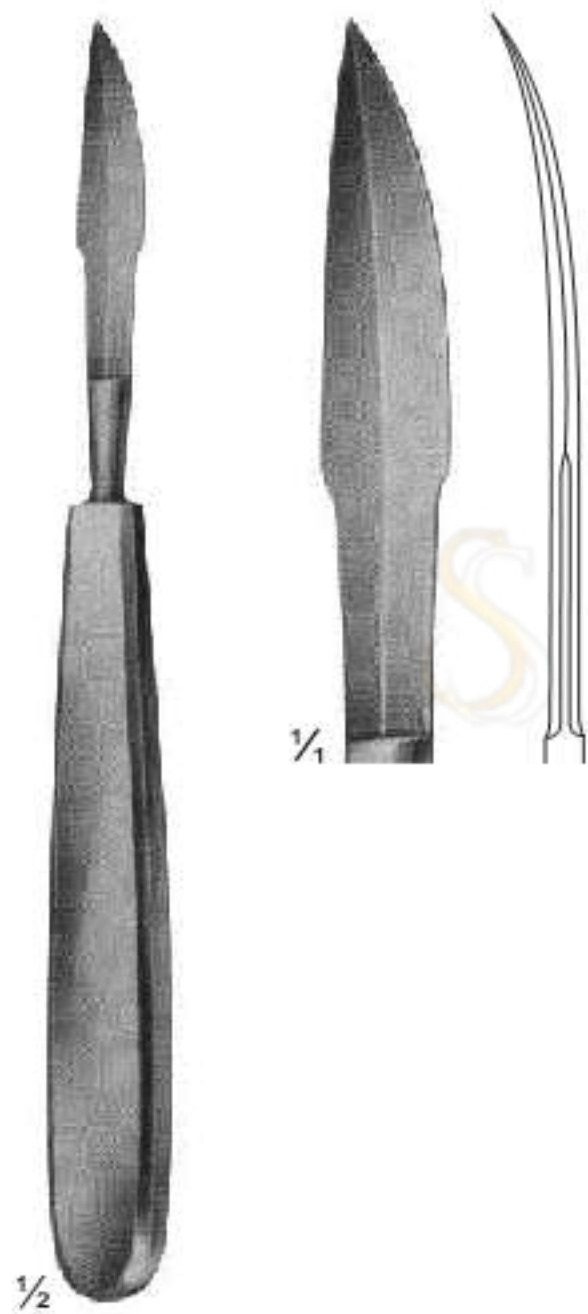

**22-201**  
170 mm

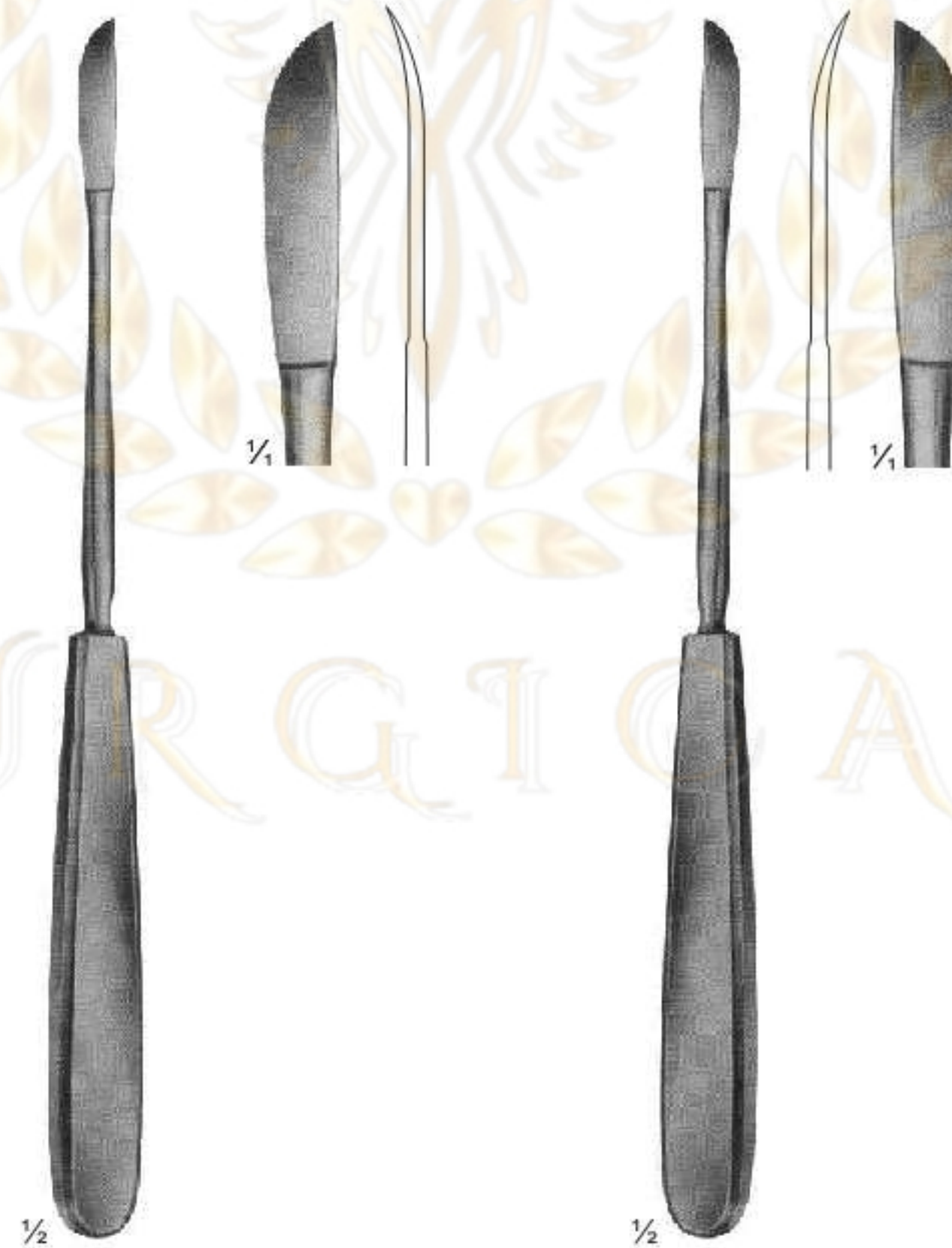

**22-202**  
NEFF  
215 mm

**22-203**  
NEFF  
215 mm



**22-204**  
WAGNER  
215 mm

# Meniscus Knives

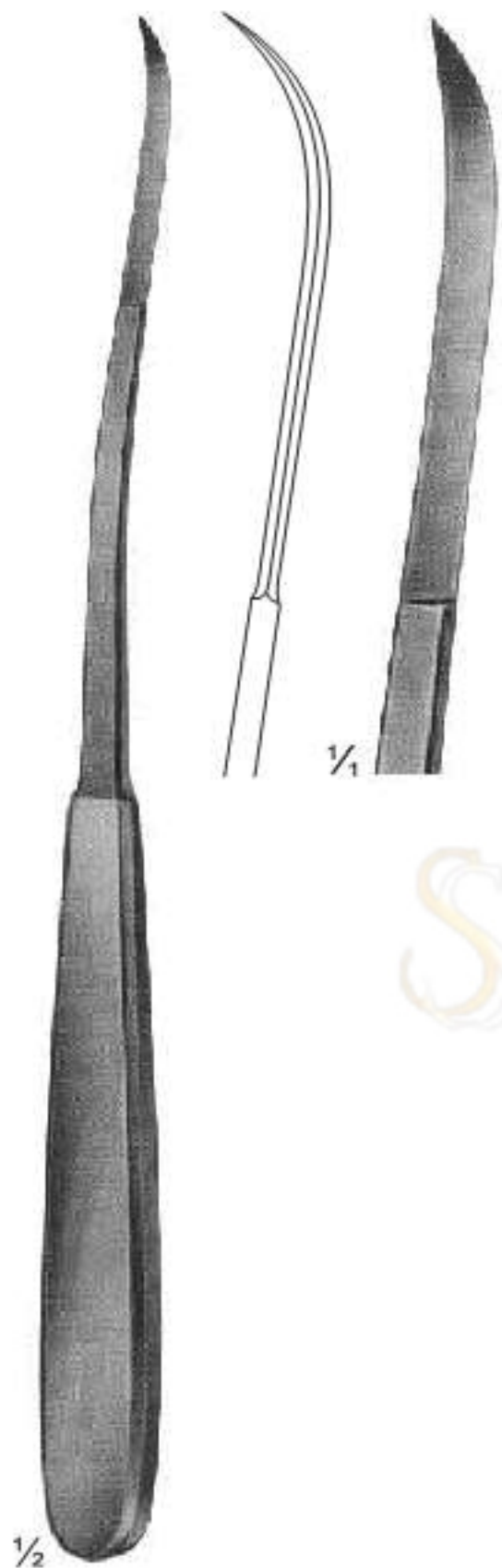

**22-205**  
SALENIUS  
220 mm



**22-206**  
CHNAD.MODELL  
200 mm

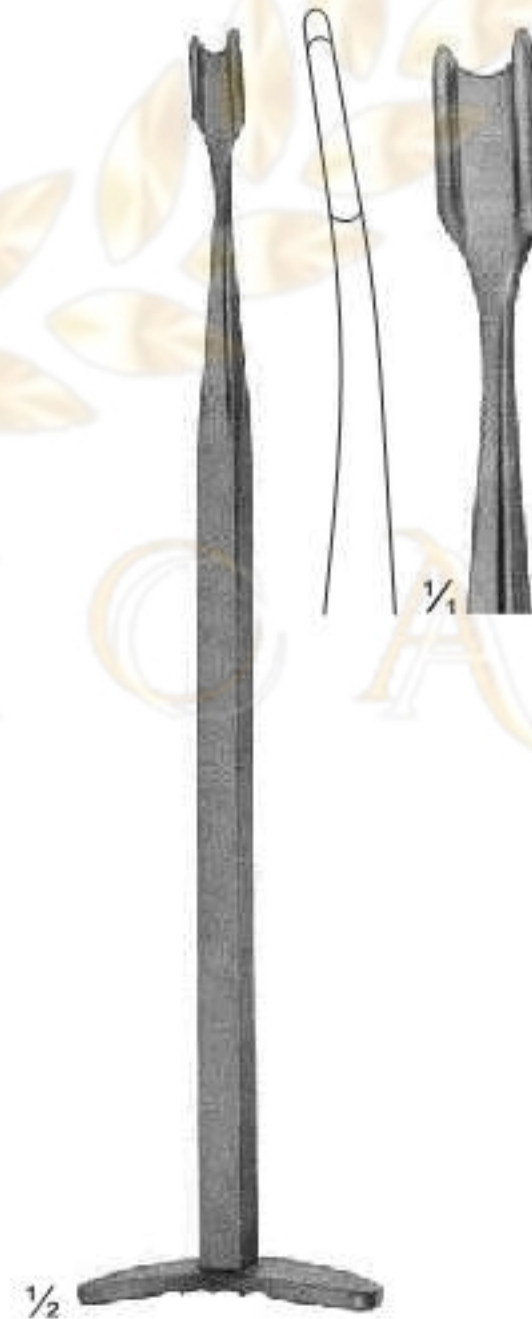

**22-207**  
SMILLIE  
170 mm

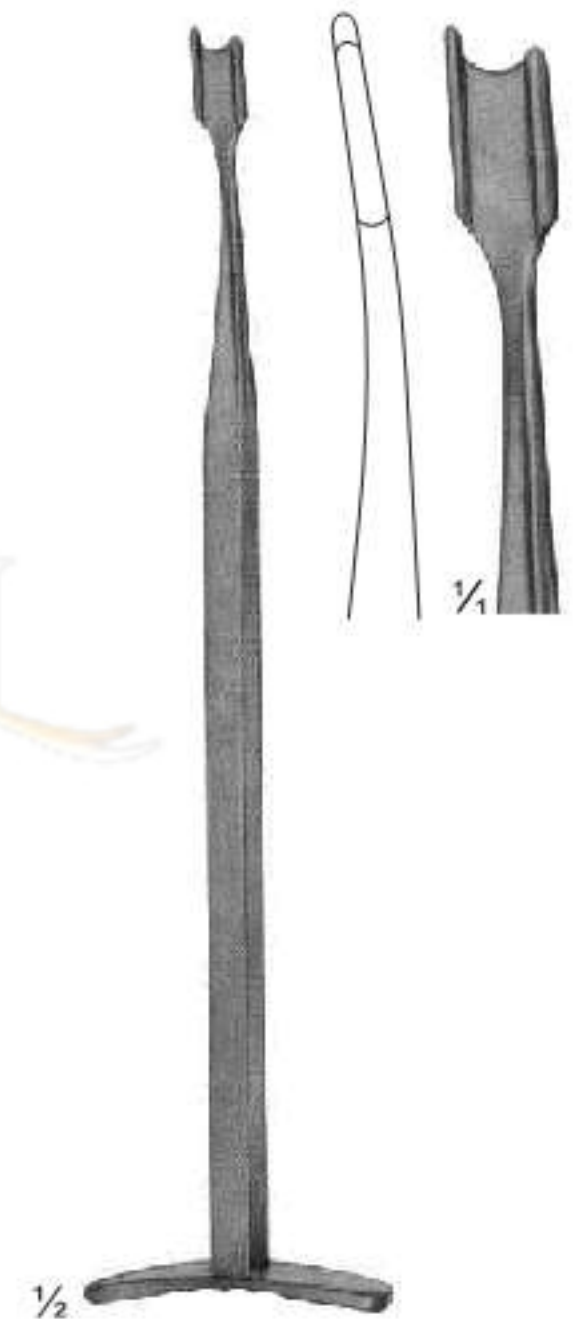

**22-208**  
SMILLIE  
170 mm

# Wire Extension

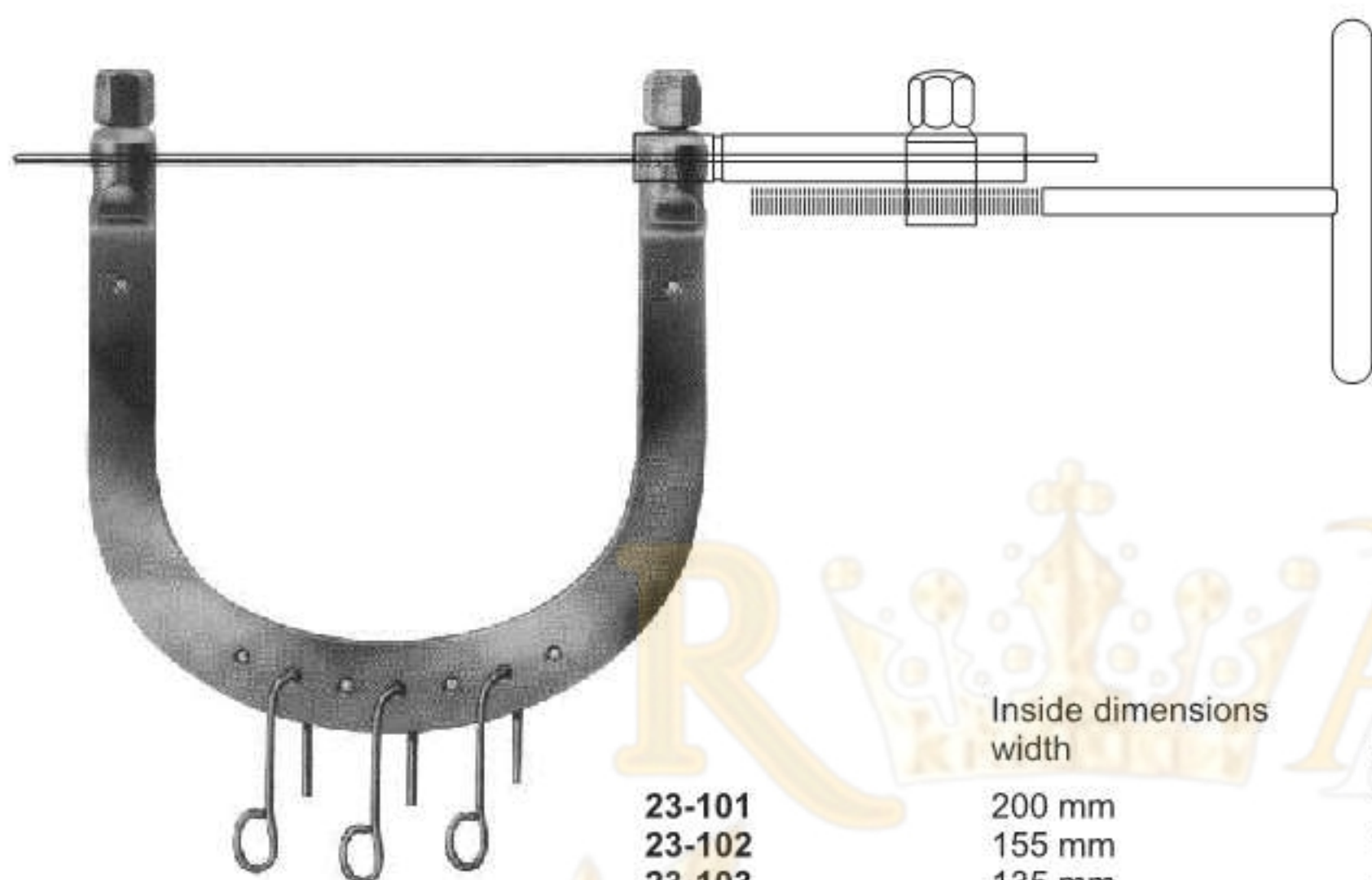

**23-101 - 107**  
**KIRSCHNER**  
 Wire traction bows,  
 to be used with  
 KIRSCHNER-wires  
 up to 2.5 mm diam.,  
 With 3 hooks,  
 stainless steel

	Inside dimensions width	depth
23-101	200 mm	155 mm
23-102	155 mm	155 mm
23-103	135 mm	130 mm
23-104	120 mm	120 mm
23-105	105 mm	100 mm
23-106	95 mm	110 mm
23-107	95 mm	70 mm



**23-108**  
 Wrench, double - ended,  
 for wire traction bows



**23-109**  
 Wire tightener, with  
 clamping jaws



1/3

**23-110**  
 Traction hook only,  
 large size



1/3

**23-111**  
 Traction hook only,  
 small size



1/3

**23-112**  
 Fixation clamp, to secure clamping  
 jaws of stainless steel

# Wire Extension

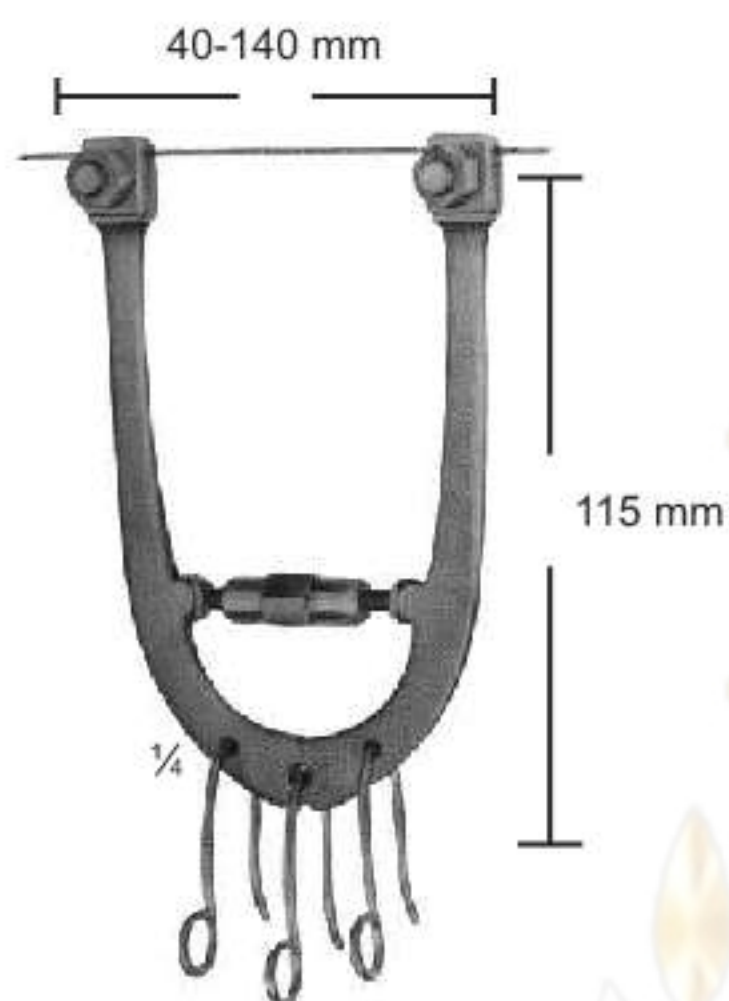

**23-113**  
Wire traction bow, adjustable,  
with 3 hooks, small size

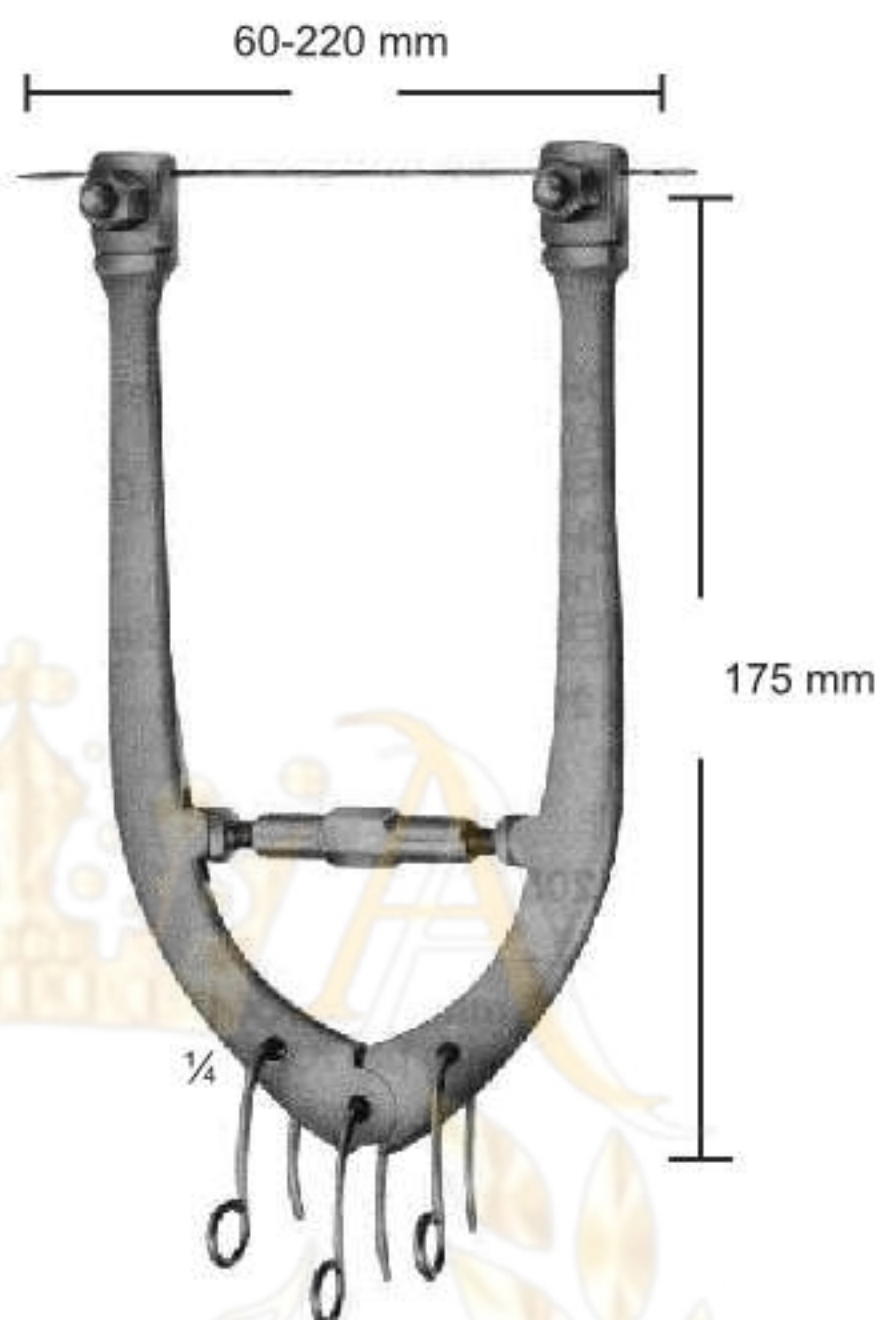

**23-114**  
Wire traction bow, adjustable,  
with 3 hooks, large size

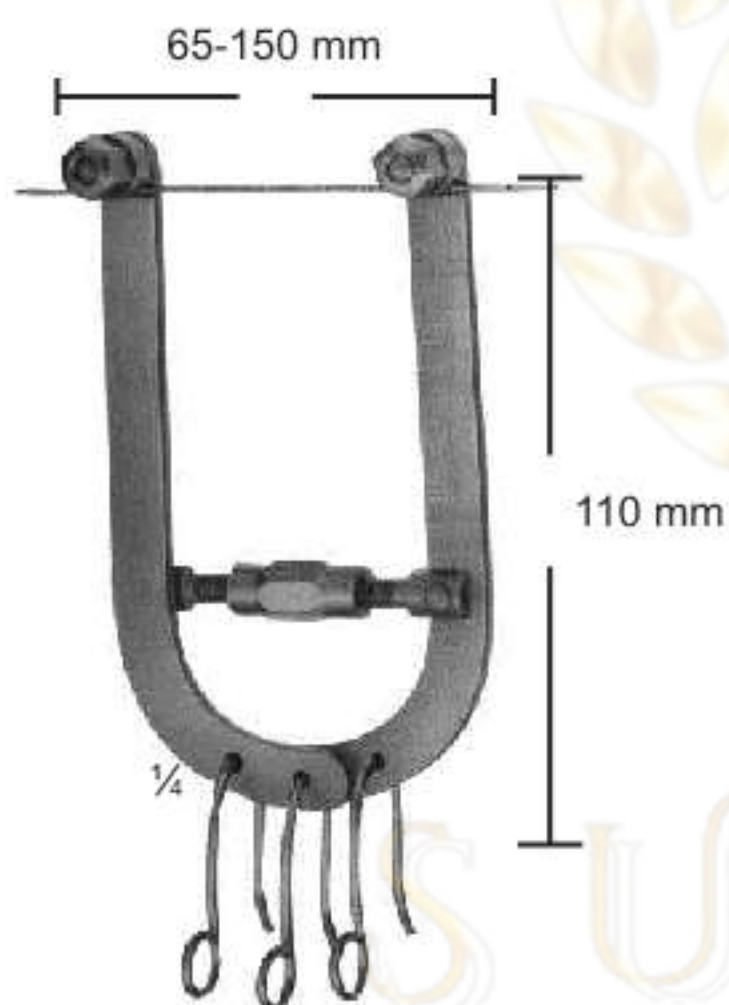

**23-115**  
Wire traction bow, adjustable,  
with 3 hooks, large size for  
elbow and calcaneus, for  
adolescents



**23-116 - 118**  
**KIRSCHNER**  
Wire traction bow, modified  
adjustable in with width, holds wire  
securely, with 1 hook

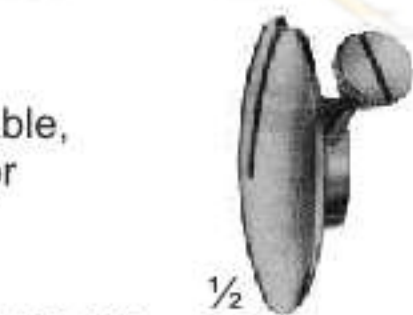

**23-119**  
Fixation disc, slotted

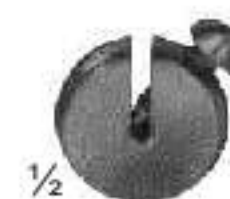

**23-121**  
Fixation disc, slotted



**23-120**  
idem, aluminum, transparent  
to X-rays



**23-122**  
Screw driver, for above  
fixations discs

# Traction Bows, Distractor

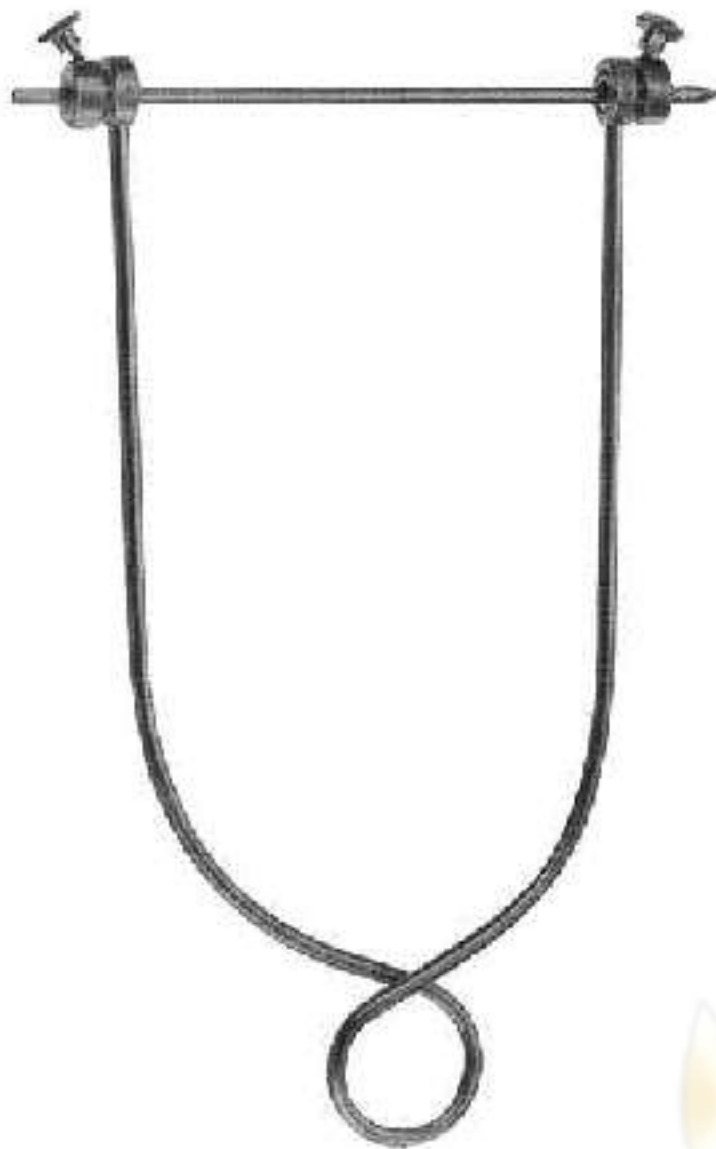

**23-123 - 130**  
Screw driver, for above fixations discs

Steinmann pins, 4 mm daim.		Steinmann pins, 5 mm daim.	
<b>23-123</b> with pin		16x9cm	Arm
<b>23-124</b> without pin	<b>23-129</b> without		
<b>23-125</b> with pin		21x11cm	Arm
<b>23-126</b> without pin	<b>23-130</b> without		
<b>23-127</b> with pin		21x15cm	Arm
<b>23-128</b> without pin			



**23-131**  
**SCHWARZ**  
Traction bow for fingers,  
to be used with KIRSCHNER-  
wire up to 1.6 mm diam.

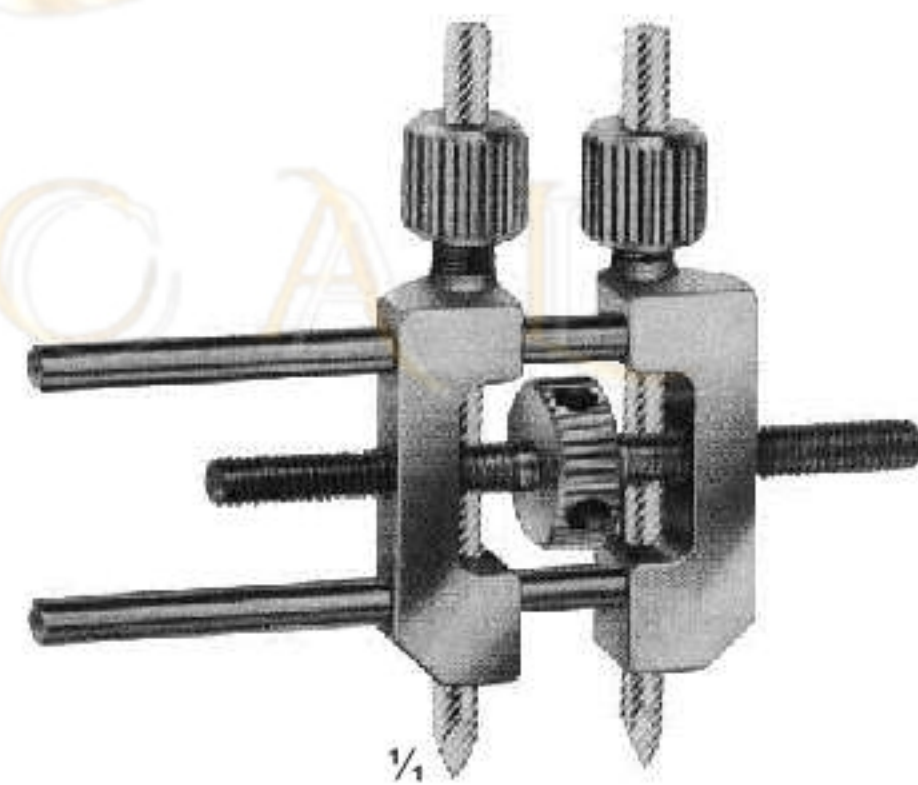

**23-132**  
Small distractor  
as a repositioning device for  
distraction and compression of small bones,  
for wires with 3.0 mm diam.



**23-133 - 147**  
STEINMANN  
triangular shaft ended and trocar point

Length	4,0 mm	5,0 mm
80 mm	<b>23-133</b>	
100 mm	<b>23-134</b>	
120 mm	<b>23-135</b>	
140 mm	<b>23-136</b>	
150 mm	<b>23-137</b>	<b>23-143</b>
160 mm	<b>23-138</b>	
180 mm	<b>23-139</b>	<b>23-144</b>
200 mm	<b>23-140</b>	<b>23-145</b>
210 mm	<b>23-141</b>	
250 mm	<b>23-142</b>	<b>23-146</b>
300 mm		<b>23-147</b>



1/4

**23-148**  
Protection cap  
for 4,0 mm STEINMANN Pins



1/4

**23-149**  
Protection cap  
for 5,0 mm STEINMANN Pins

# Drilling Chucks



**23-150**  
REILL  
Drilling chuck, cannulated, for shanks from 2.0 - 2.5 mm diam 115 mm



**23-151**  
Drilling chuck, cannulated, for shanks from 0.8 - 2.0 mm diam 150 mm



**23-152**  
Drilling chuck, cannulated, for shanks up to 4.5 mm diam with key 140 mm



**23-153**  
LOUTE  
Wire tightener, improved pattern, with movable tip, for wires up to 1.0 mm diam. 220 mm



**23-154**  
Drilling chuck, cannulated, for shanks up to 6.35 mm diam., To be tightened by hand 100 mm



**23-155**  
Drilling chuck, cannulated, for shanks up to 4.5 mm diam., And for triangular shaft width across flats 4.7 mm



**23-156**  
Drilling chuck, cannulated, for shanks up to 6.35 mm diam., With key 160 mm



# Cerclage Instruments

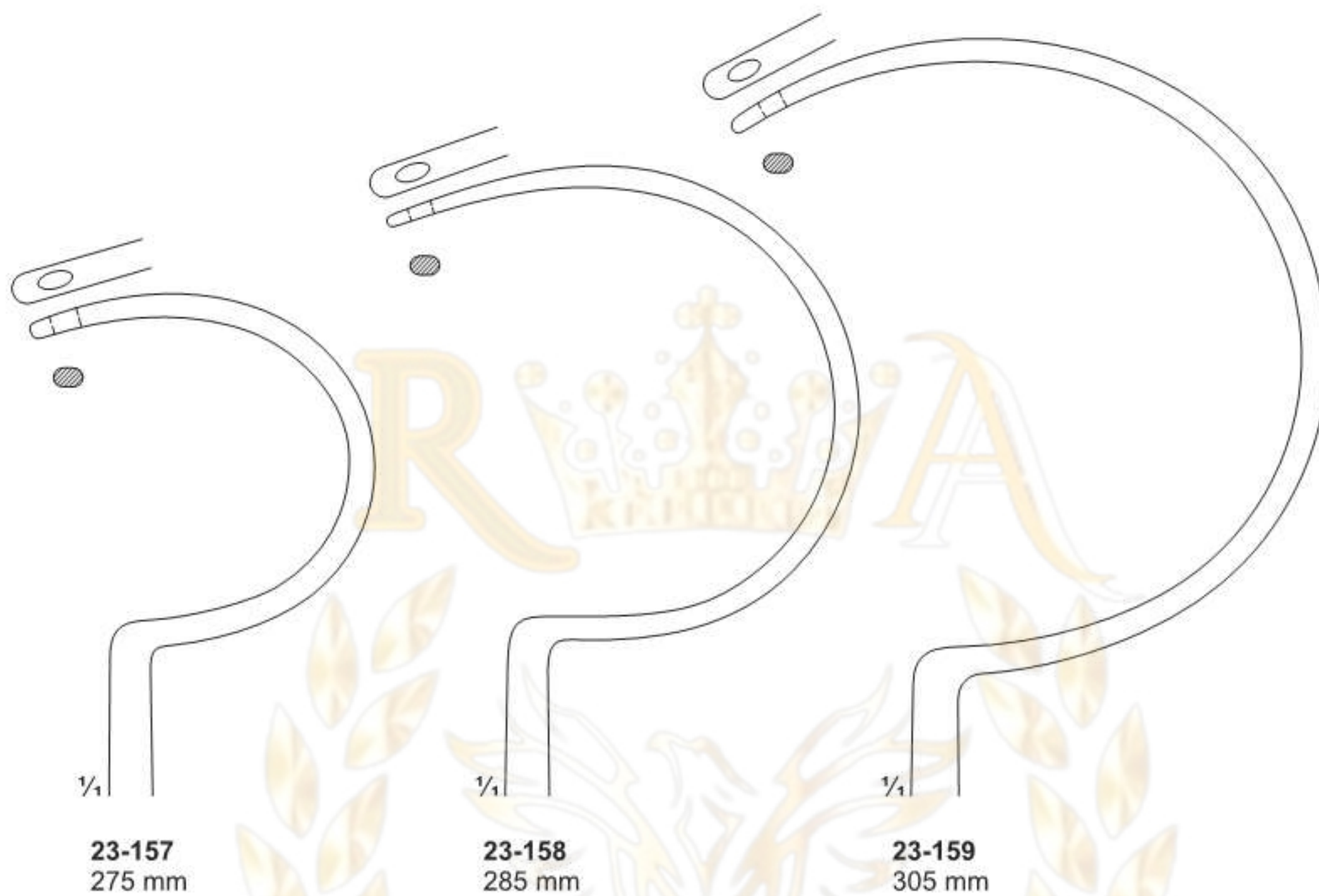

23-157  
275 mm

23-158  
285 mm

23-159  
305 mm

23-157 - 159  
DEMEL  
Wire guides



23-160  
240 mm

23-161  
270 mm

23-162  
225 mm

# JORDAN instruments for subcutaneous Tibia Cerclage



**23-163**  
JORDAN  
Wire tightener



$\frac{1}{2}$   
**23-164**  
JORDAN  
Wire twister  
170 mm



$\frac{1}{2}$   
**23-165**  
JORDAN  
Wire catcher  
180 mm



$\frac{1}{2}$   
**23-166**  
JORDAN  
Probe, cannulated  
170 mm

# Wire Holding forceps, Wire Tightening Pliers, Flat-nosed Pliers

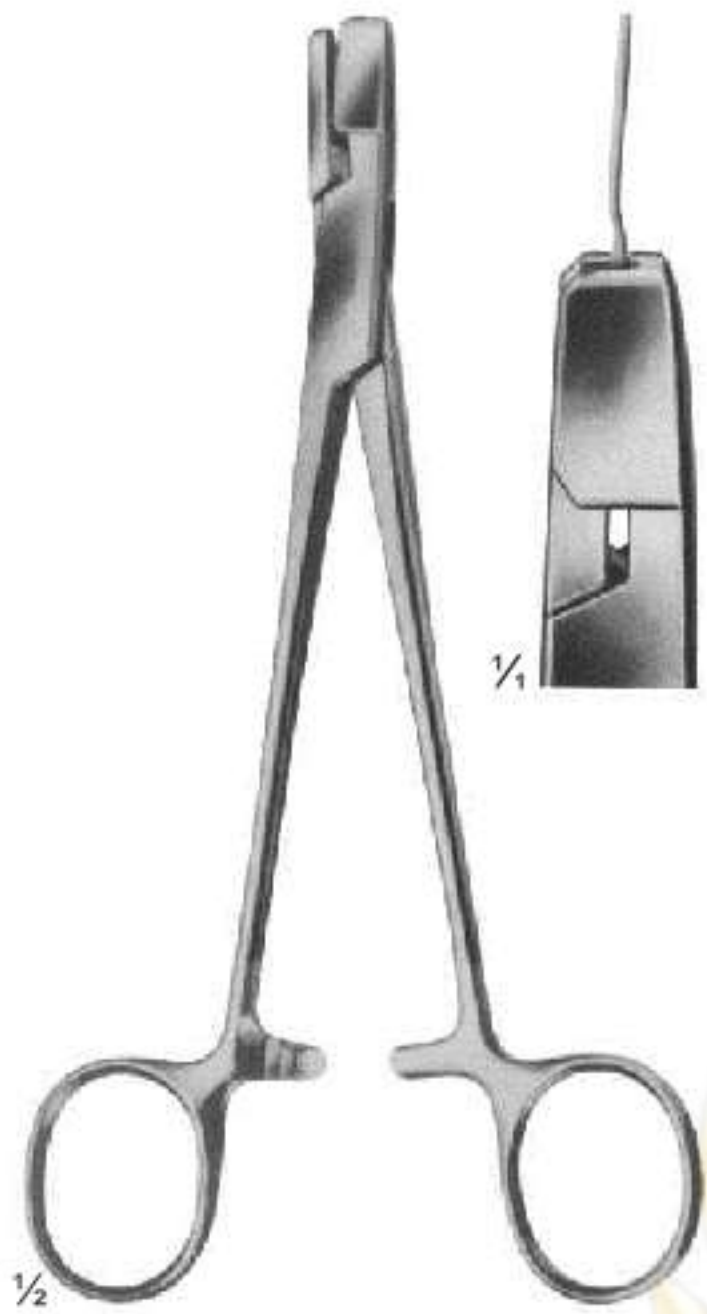

**23-167**  
DUROGRIP  
Holding forceps for cerclage wire, with lateral jaws to avoid wire slipping off  
170 mm



**23-168**  
DUROGRIP  
Wire, tightening pliers, Ligature pliers  
150 mm



**23-169**  
DUROGRIP  
Wire, tightening pliers, Ligature pliers  
150 mm

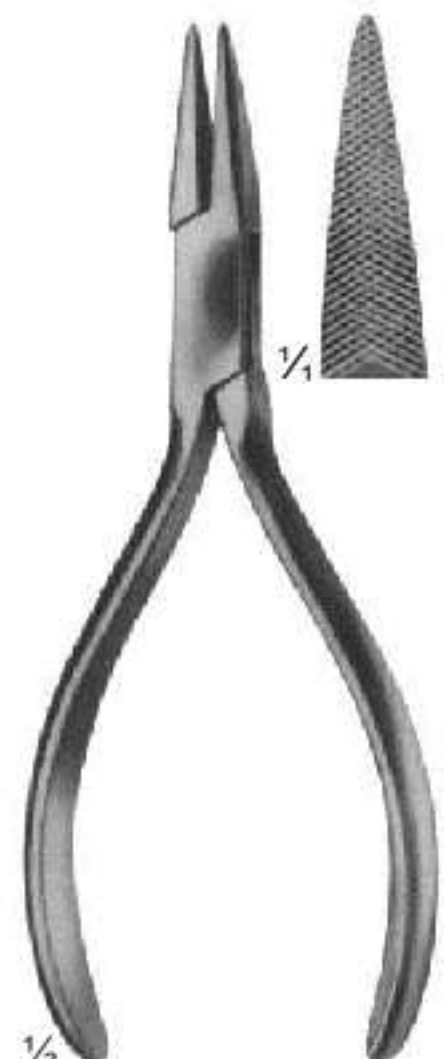

**23-170**  
with serrated jaws  
140 mm



**23-171**  
one jaws smooth, one jaws serrated  
140 mm



**23-172**  
with serrated jaws  
**23-173**  
with longitudinal and transversal grooves  
170 mm



**23-174**  
190 mm

# Wire Holding forceps, Flat-nosed Pliers, Pliers for bending and cutting wires



23-175  
130 mm

23-176  
180 mm

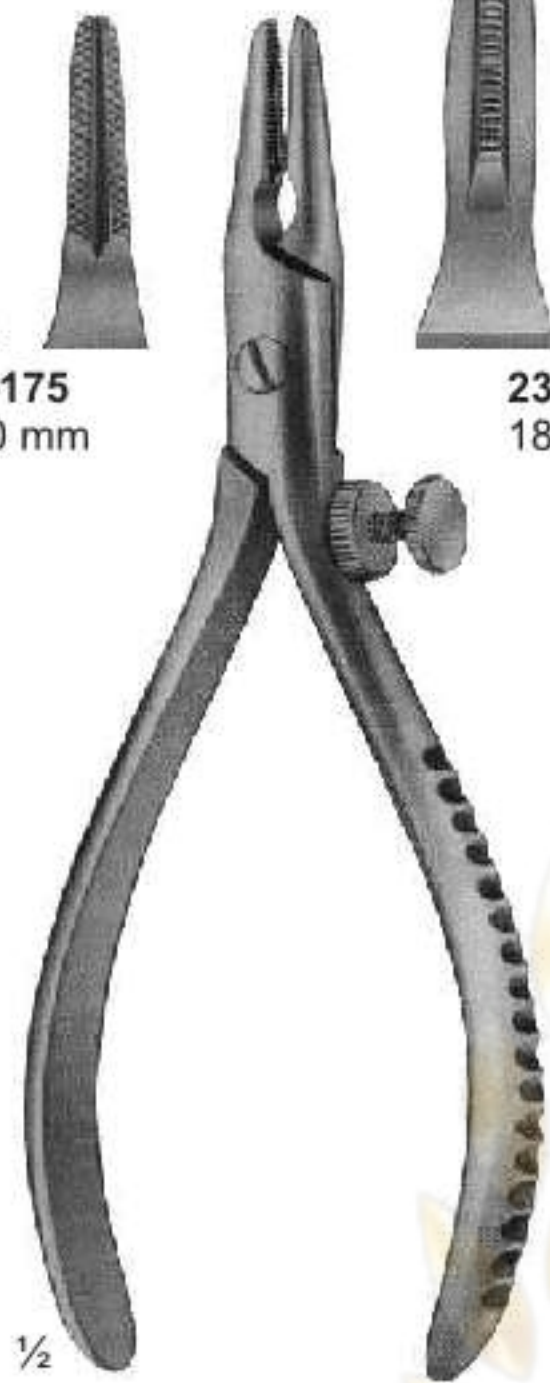

23-175 - 176  
Extraction pliers  
for boring wires



23-177  
Flat-nosed pliers,  
parallel  
185 mm

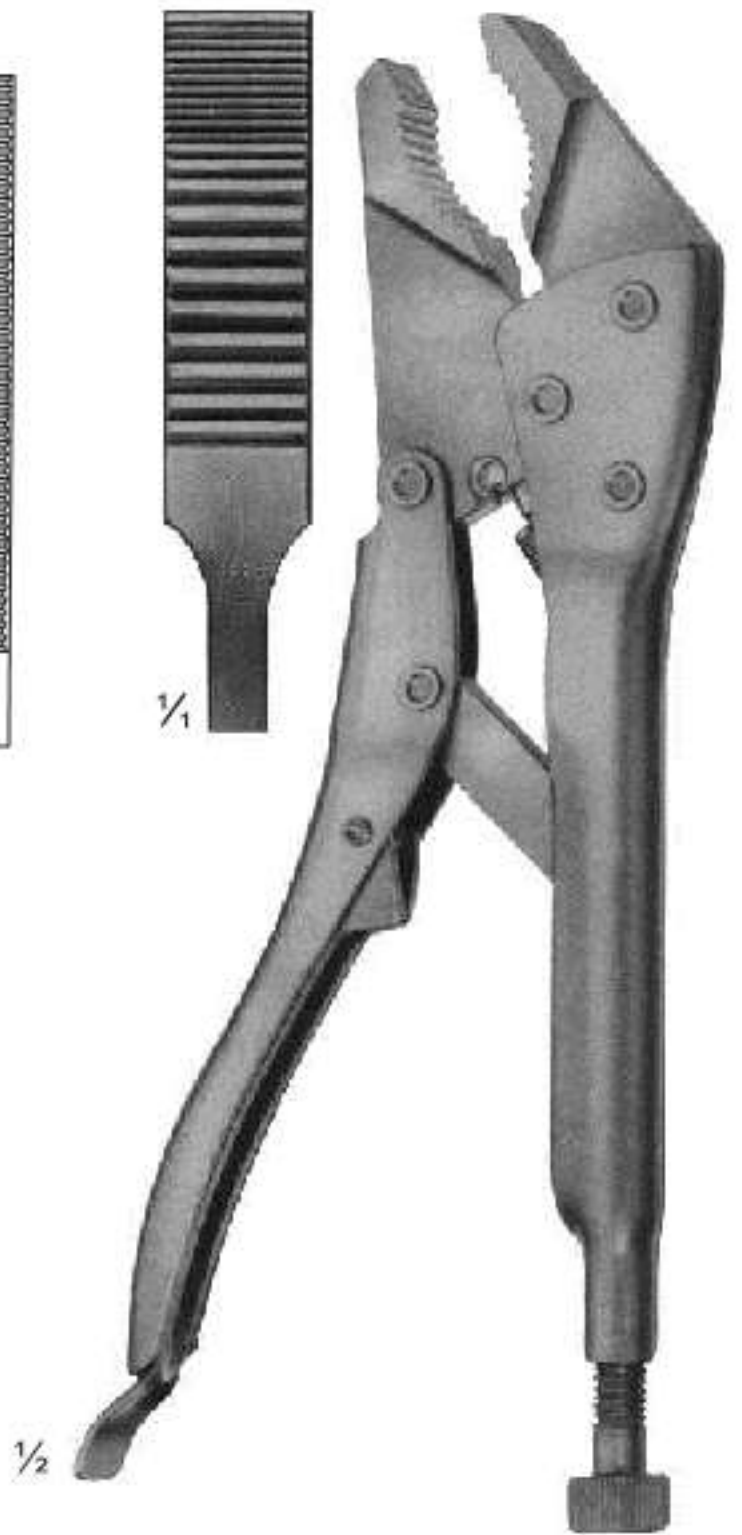

23-178  
Vise grip  
200 mm

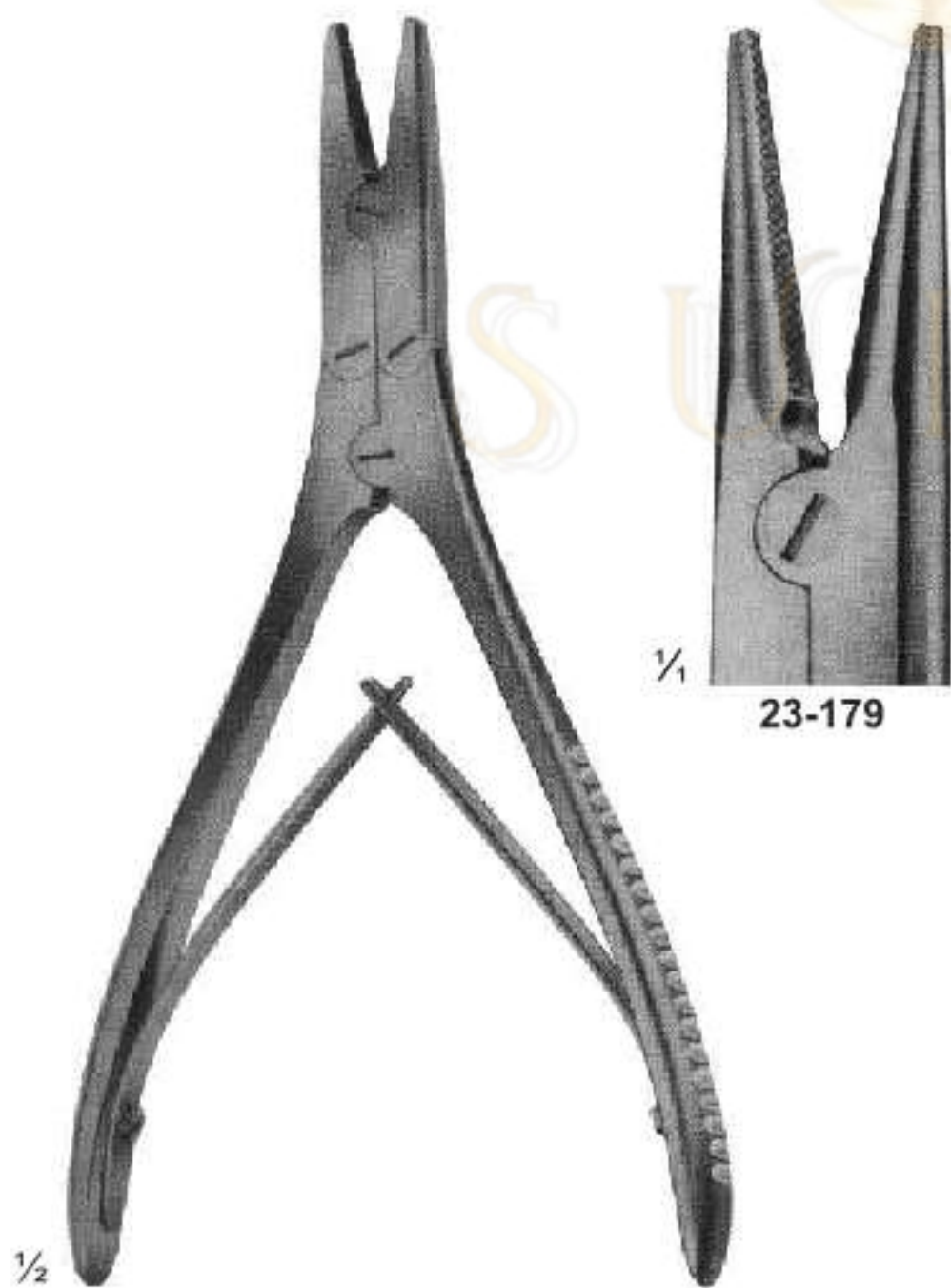

23-179 - 183  
Round pliers  
180 mm

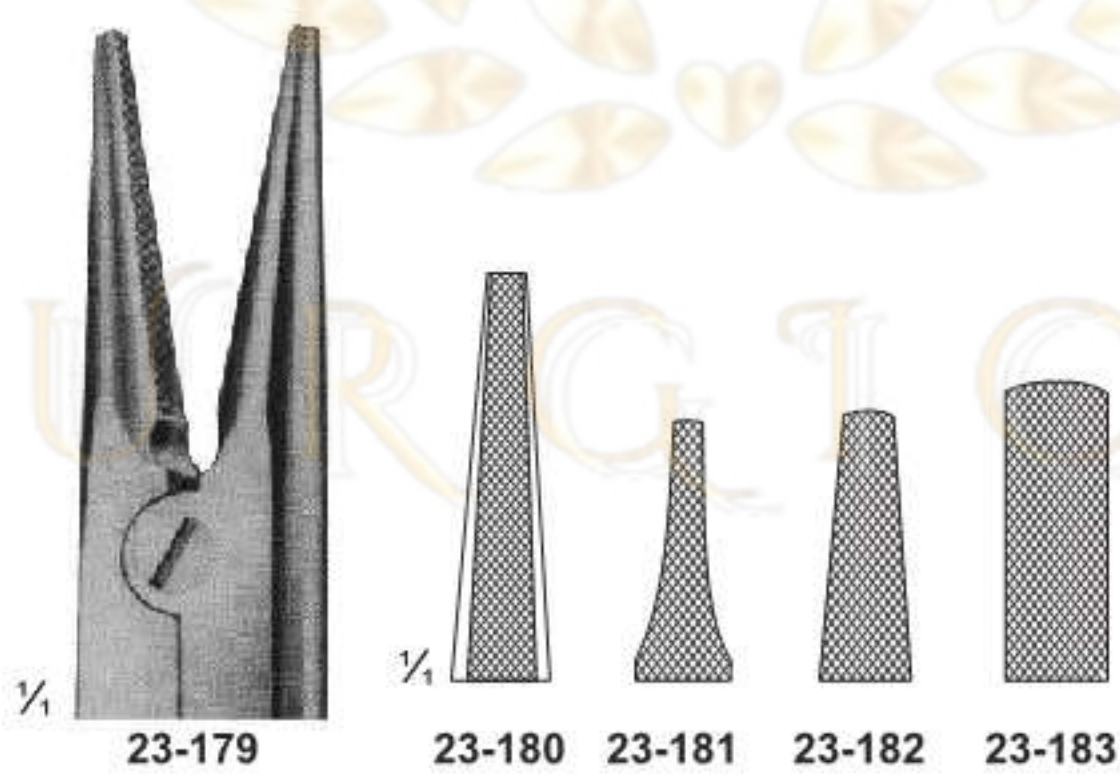

23-180  
23-181 145 mm  
23-182 180 mm  
23-183 180 mm  
Extraction pliers for wires



23-184  
Bending pliers  
for wires up to  
1.8 mm diam.

# Wire Cutters and wire Cutting Scissors

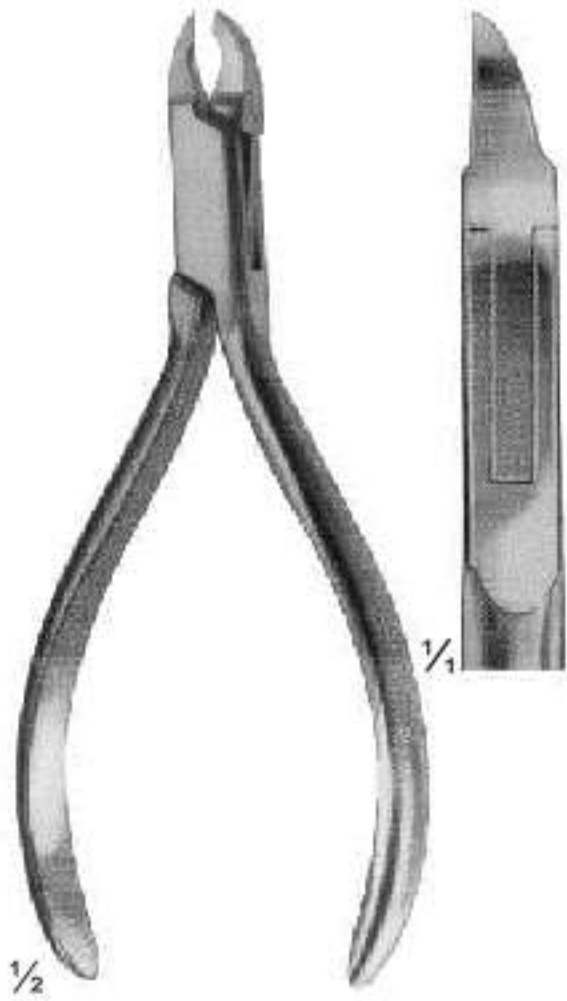

**23-185**  
ANGLE  
130 mm

for soft wire  
up to diam.  
for hard wire  
up to diam.

**23-186**  
DUROTIP  
ANGLE  
130 mm

0,5 mm	0,6 mm
0,3 mm	0,4 mm

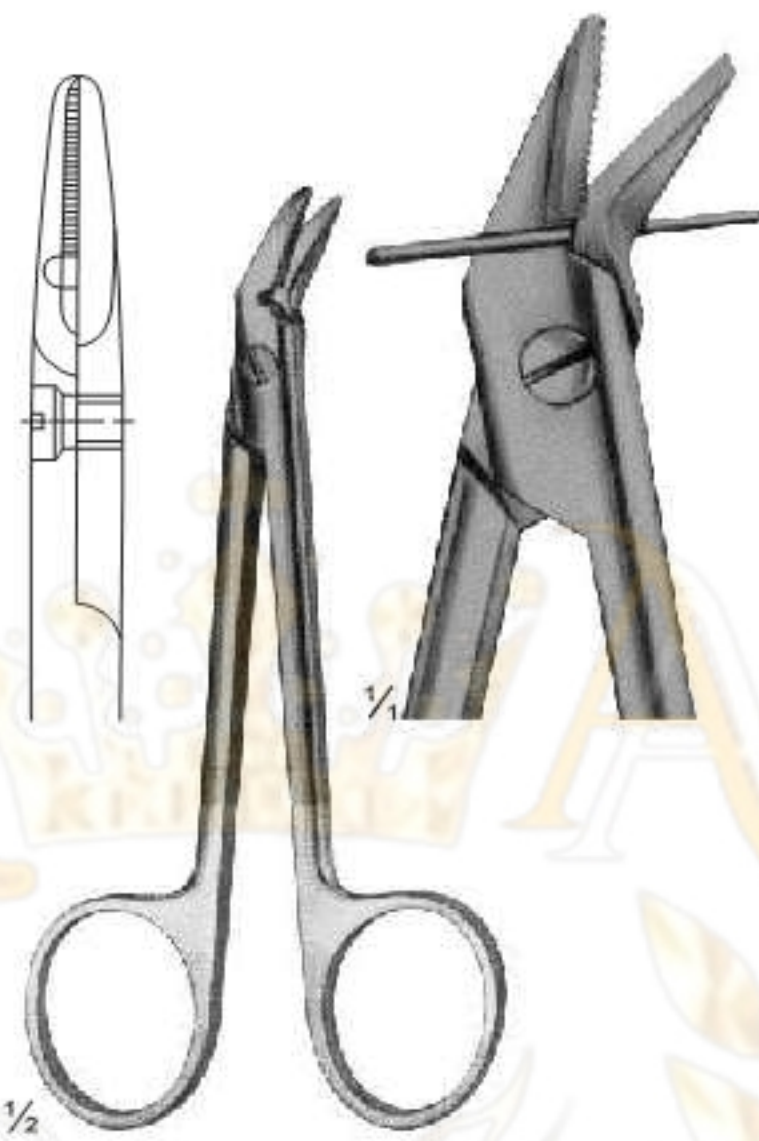

**23-187**  
120 mm

for soft wire  
up to diam.  
for hard wire  
up to diam.

**23-188**  
DUROTIP  
120 mm

1,2 mm	1,2 mm
0,8 mm	0,8 mm

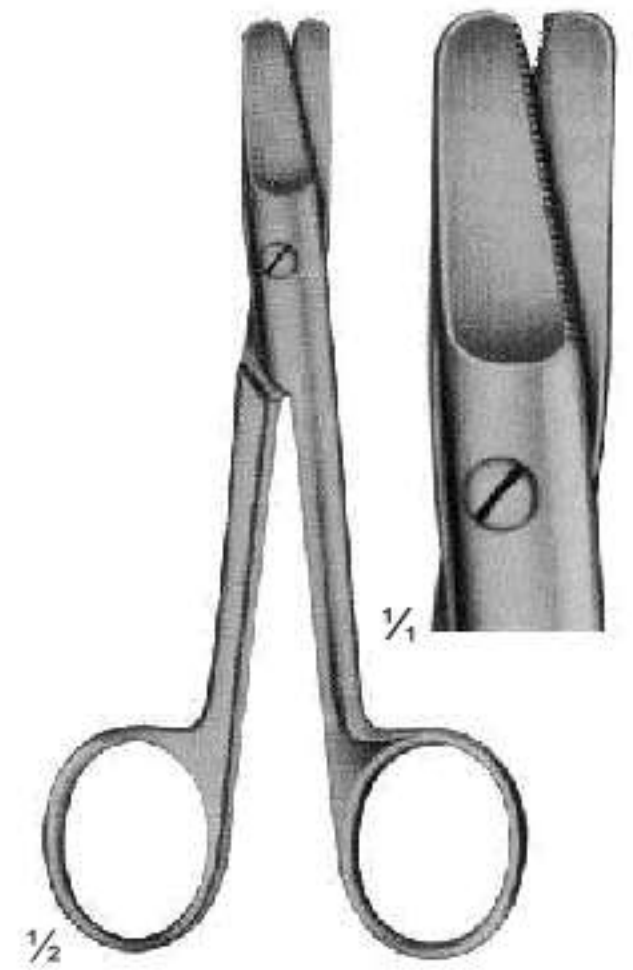

**23-189**  
HARVEY  
125 mm

0,4 mm
0,3 mm

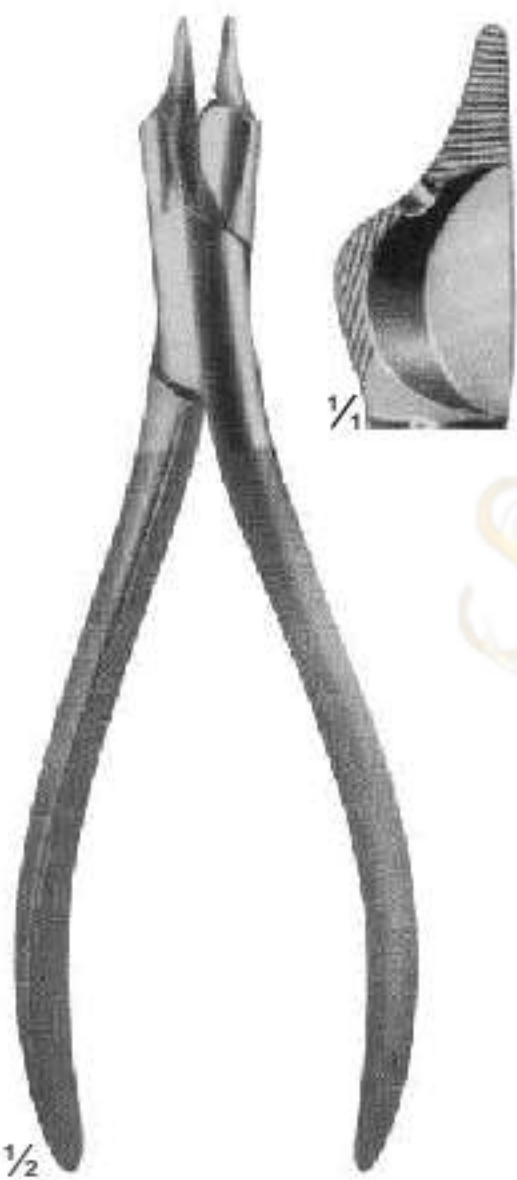

**23-190**  
150 mm

for soft wire  
up to diam.  
for hard wire  
up to diam.

1,5 mm
1,0 mm



**23-191**  
160 mm

1,5 mm
1,2 mm



**23-192**  
140 mm

1,5 mm
1,0 mm

# Wire Cutting Pliers, Lateral Cutting Action



**23-193**  
180 mm

for soft wire  
up to diam. 2,0 mm  
For hard wire 1,5 mm  
up to diam  
specially hardened  
cutting edges, front  
and lateral cutting  
action

**23-194**  
REILL  
175 mm

for soft wire  
up to diam. 2,0 mm  
For hard wire 1,6 mm  
up to diam  
specially hardened  
cutting edges, for  
cutting off wires close  
to the bone

**23-195**  
235 mm

for soft wire  
up to diam. 3,0 mm  
For hard wire 2,2 mm  
up to diam

# Wire Cutting Pliers, Lateral and Front Cutting Action

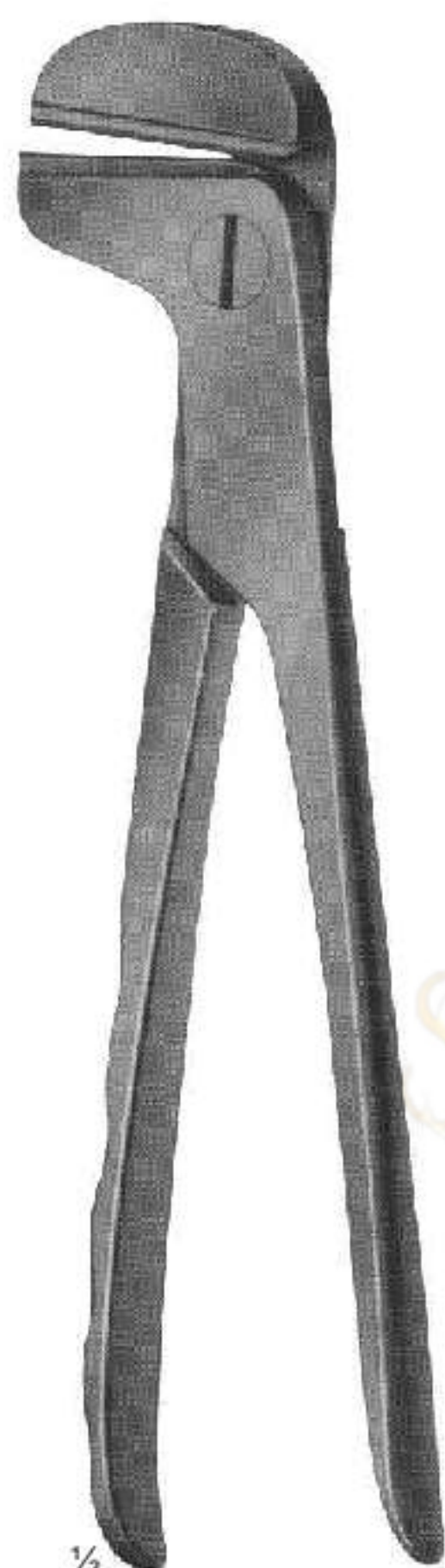

1/2  
**23-196**  
 240 mm

for soft wire  
 up to diam. 2,0 mm  
 For hard wire  
 up to diam 1,6 mm

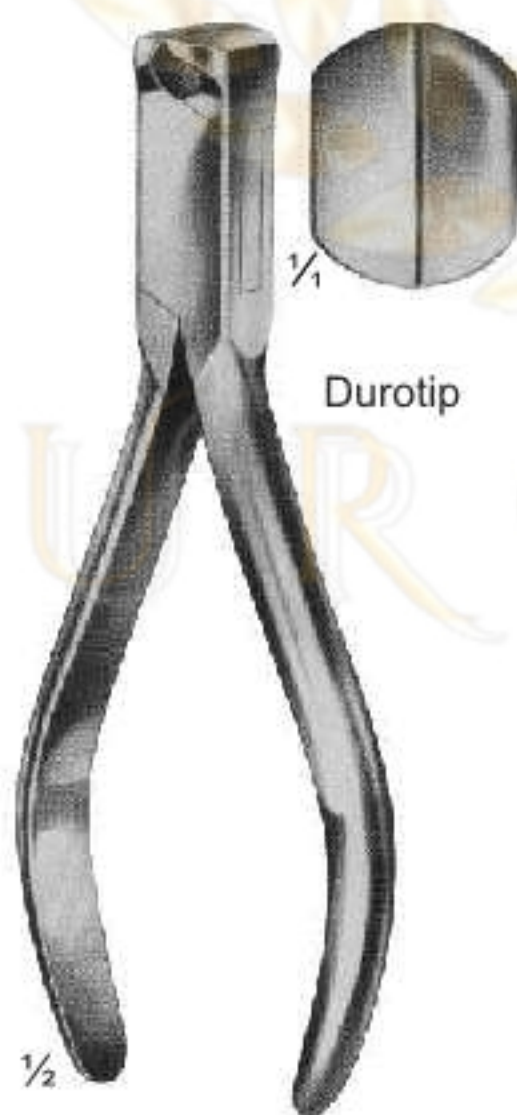

1/2  
**23-197**  
 140 mm

for soft wire  
 up to diam. 1,5 mm  
 For hard wire  
 up to diam 1,0 mm



1/2  
**23-198**  
 145 mm

for soft wire  
 up to diam. 2,0 mm  
 For hard wire  
 up to diam 1,5 mm



1/2  
**23-199**  
 220 mm

for soft wire  
 up to diam. 3,5 mm  
 For hard wire  
 up to diam 2,5 mm

# Wire Cutting Pliers



Cutter for cutting off  
KIRSCHNER wires,  
Tibia head screws,  
bolts, pins, up to 3 mm diam.

Durotip

**23-200**  
320 mm

for soft wire up to diam. 3,0 mm  
For hard wire up to diam 3,0 mm

**23-201**  
Cutter for cutting off  
KIRSCHNER wires,  
Tibia head screws,  
bolts, pins, up to 6 mm diam.  
470 mm



# Finger Nail Instruments

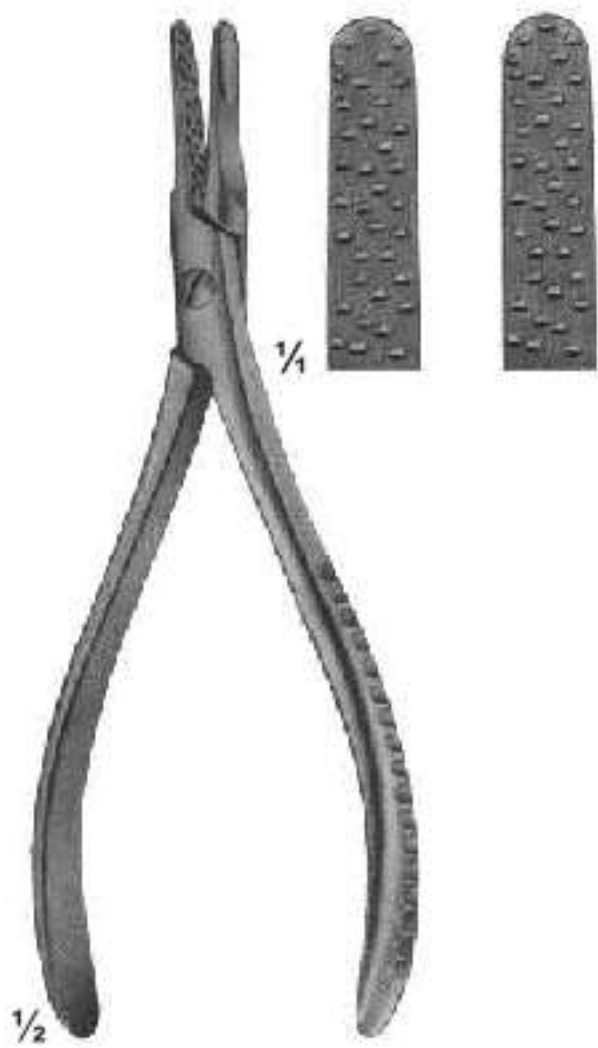

**23-202**  
Nail extracting  
forceps  
135 mm



**23-203**  
Nail extracting  
forceps  
145 mm

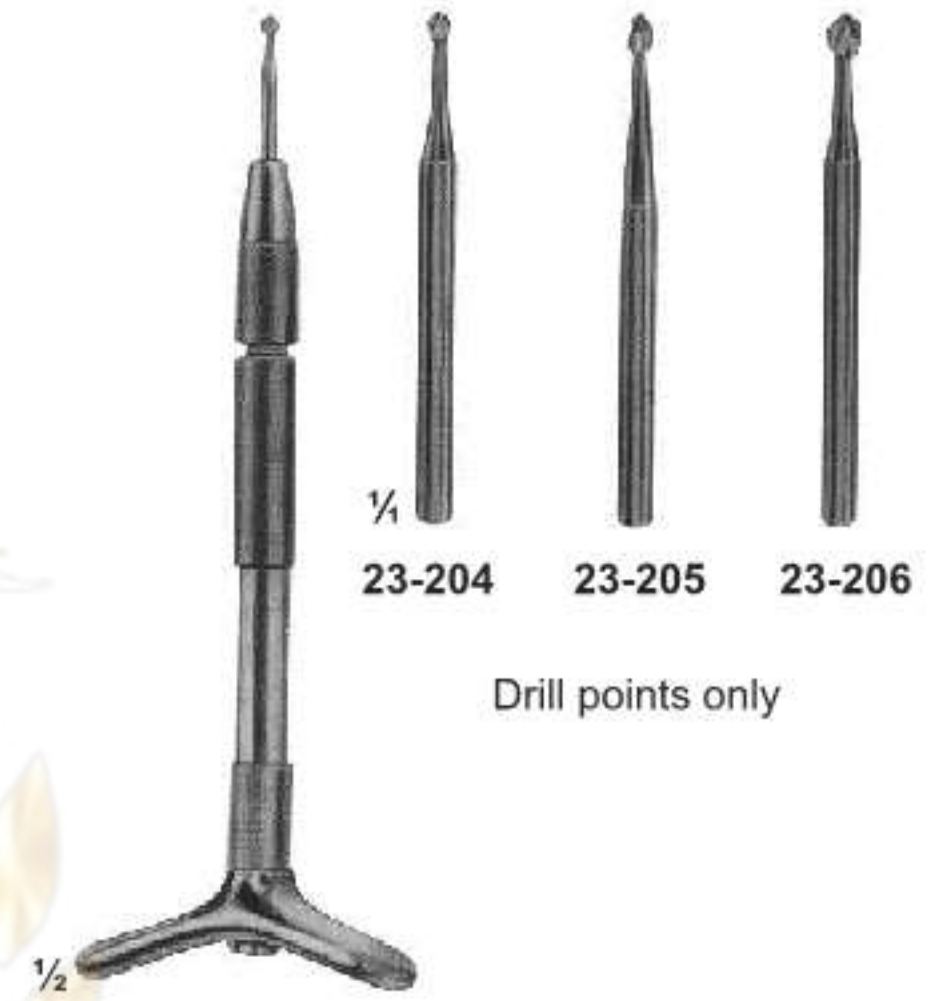

**23-204 - 206**  
Finger nail drill  
with 3 points

Drill points only

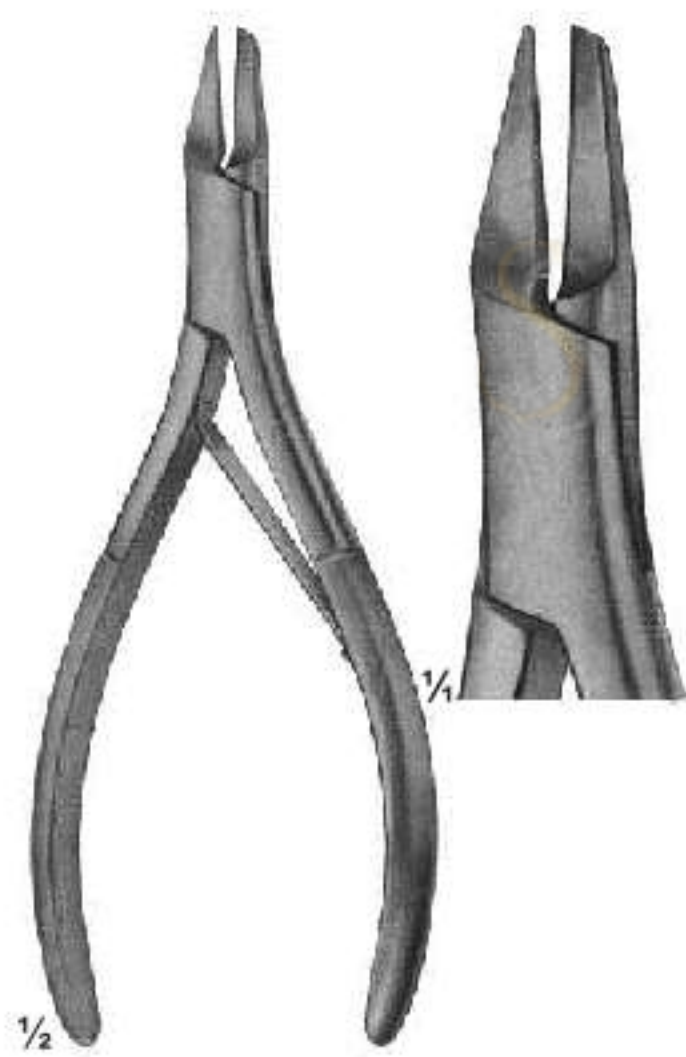

**23-207**  
Nail splitting  
forceps  
135 mm



**23-208**  
SYSTRUNK  
Scissors, for splitting  
finger nails  
130 mm

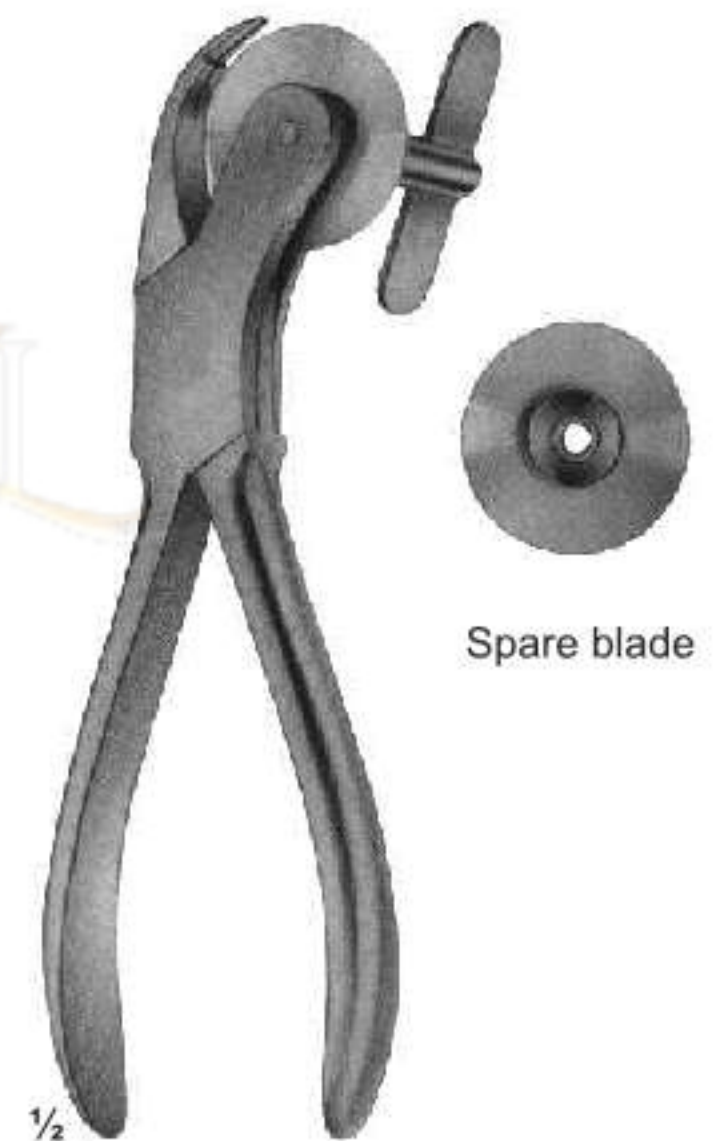

**23-209**  
Finger ring saw  
150 mm

Spare blade

# Plaster Instruments



with ebony handle

24-101  
HOPKINS  
200 mm



24-102  
ESMARCH  
180 mm



24-103  
ENGEL  
160 mm



24-104 - 112

- |        |       |        |             |
|--------|-------|--------|-------------|
| 24-104 | black | 24-108 | yellow      |
| 24-105 | red   | 24-109 | white       |
| 24-106 | blue  | 24-110 | orange      |
| 24-107 | green | 24-111 | lavender    |
|        |       | 24-112 | bright pink |



24-113 - 121

- |        |       |        |             |
|--------|-------|--------|-------------|
| 24-113 | black | 24-117 | yellow      |
| 24-114 | red   | 24-118 | white       |
| 24-115 | blue  | 24-119 | orange      |
| 24-116 | green | 24-120 | lavender    |
|        |       | 24-121 | bright pink |

# Plaster Scissors



For small plaster dressings

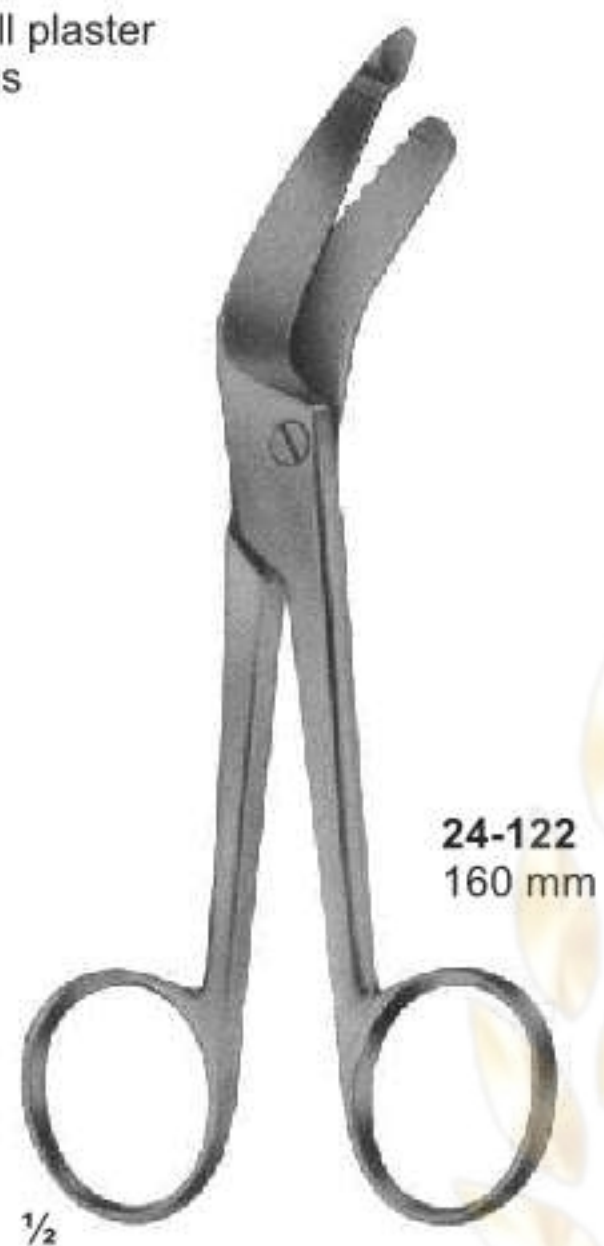

24-122  
160 mm

1/2



24-123 - 124  
ESMARCH  
200 mm 230 mm

1/2

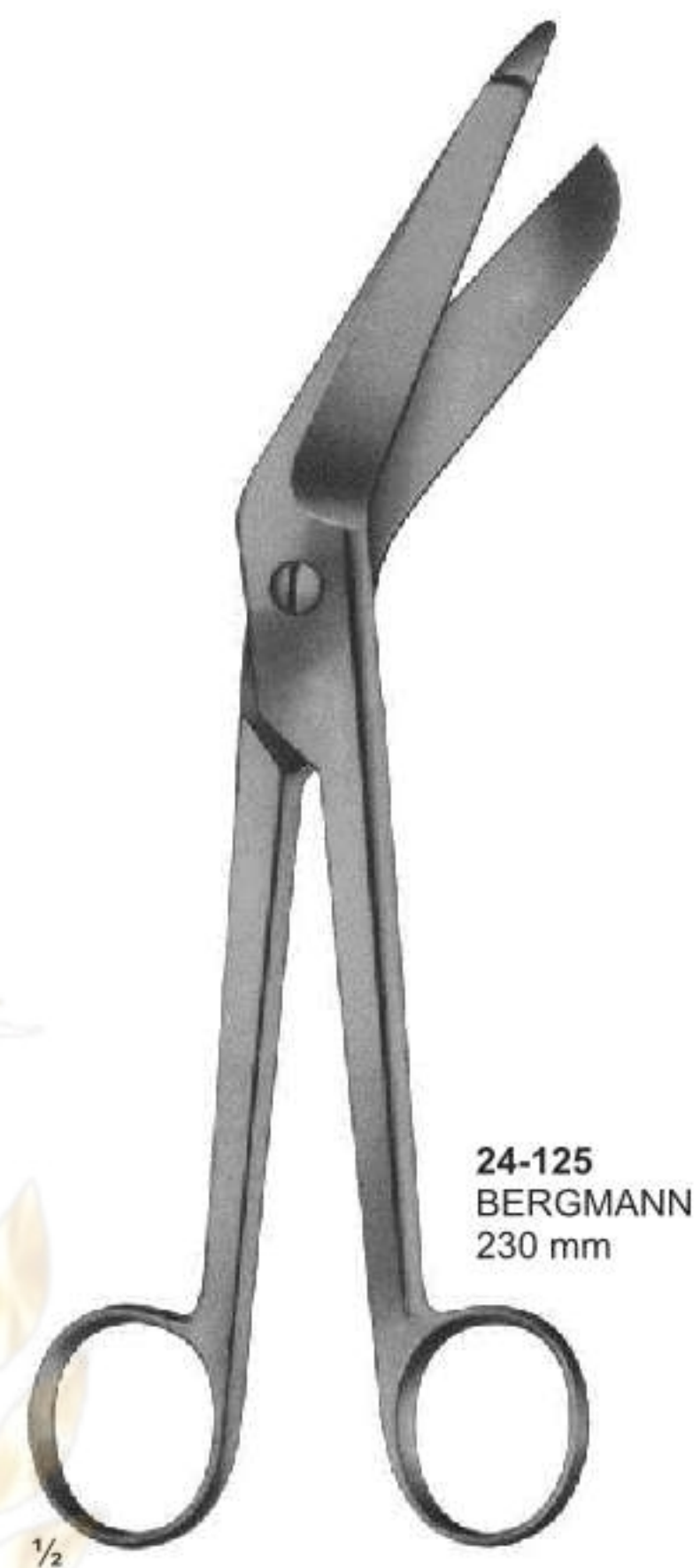

24-125  
BERGMANN  
230 mm

1/2



24-126  
BRUNS  
235 mm

1/2



24-127  
235 mm

1/2

also to be used as  
bandage scissors



24-128  
SEUTIN  
230 mm

1/2

also to be used as  
bandage scissors

# Plaster Shears



**24-129**  
STILLE-AESFULAP  
260 mm

**24-130**  
STILLE-AESFULAP  
360 mm

# STILLE Plaster Shears



Blade with reinforced back



**24-131**  
STILLE  
230 mm

**24-132**  
Spare blade



**24-133**  
STILLE  
370 mm

**24-134**  
Spare blade

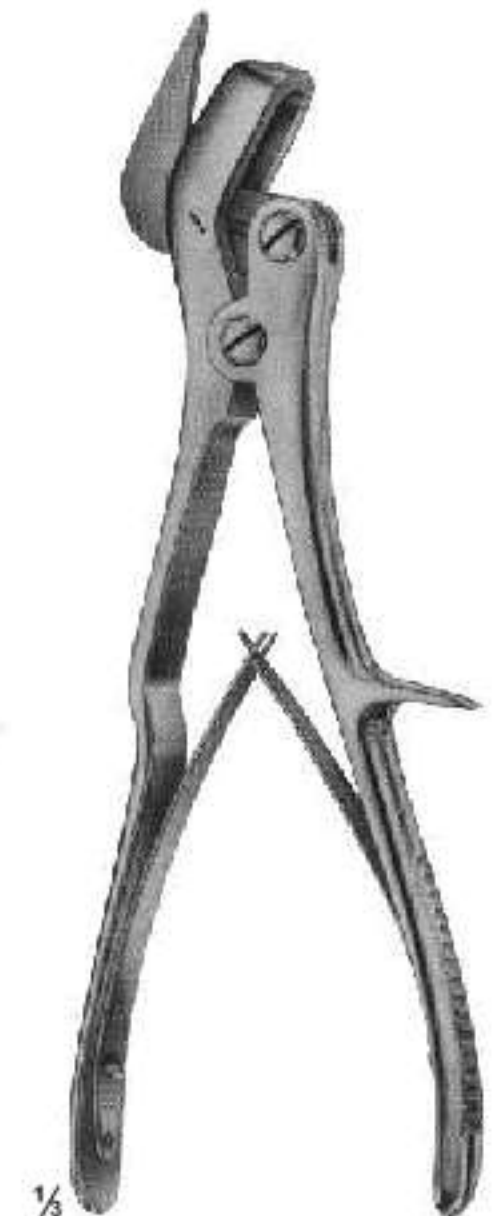

**24-135**  
STILLE  
240 mm

**24-136**  
Spare blade

# Plaster Spreader, Plaster Breakers



**24-137**  
HENING  
270 mm



**24-138**  
MOD.USA  
230 mm



**24-139**  
290 mm



with removable jaws



**24-140 - 141**  
WOLFF  
24-140 180 mm  
24-141 240 mm

# Vacuum Currettes for Aspiration Lipectomy, Suction Instruments



**25-101 - 106**  
BIEMER  
25-101 ø 4 mm  
25-102 ø 6 mm  
25-103 ø 8 mm  
25-104 ø 10 mm  
25-105 ø 12 mm  
25-106 ø 14 mm  
Currettes for aspiration lipectomy, graduated, slightly curved

**25-107 - 108**  
BIEMER  
25-107 ø 4 mm  
25-108 ø 6 mm  
Currettes for aspiration lipectomy, with three apertures, slightly curved malleable

**25-109 - 111**  
BIEMER  
25-109 ø 8 mm  
25-110 ø 10 mm  
25-111 ø 12 mm  
Currettes for aspiration lipectomy, with three apertures, slightly curved malleable

**25-112**  
For aspirating fluid from the excretory ducts of large glands and for keeping the operating area clear  
170 mm

**25-113**  
Trocar  
For puncturing  
150 mm

**25-114**  
For clearing large quantities of fluid  
190 mm



**25-115**  
Trocar  
For puncturing  
170 mm



**25-116**  
Hollow needle,  
sharp  
150 mm



**25-117**  
double curved  
For general  
surgery  
230 mm



**25-118**  
For tonsillectomy,  
oral and laryngeal  
operations  
190 mm

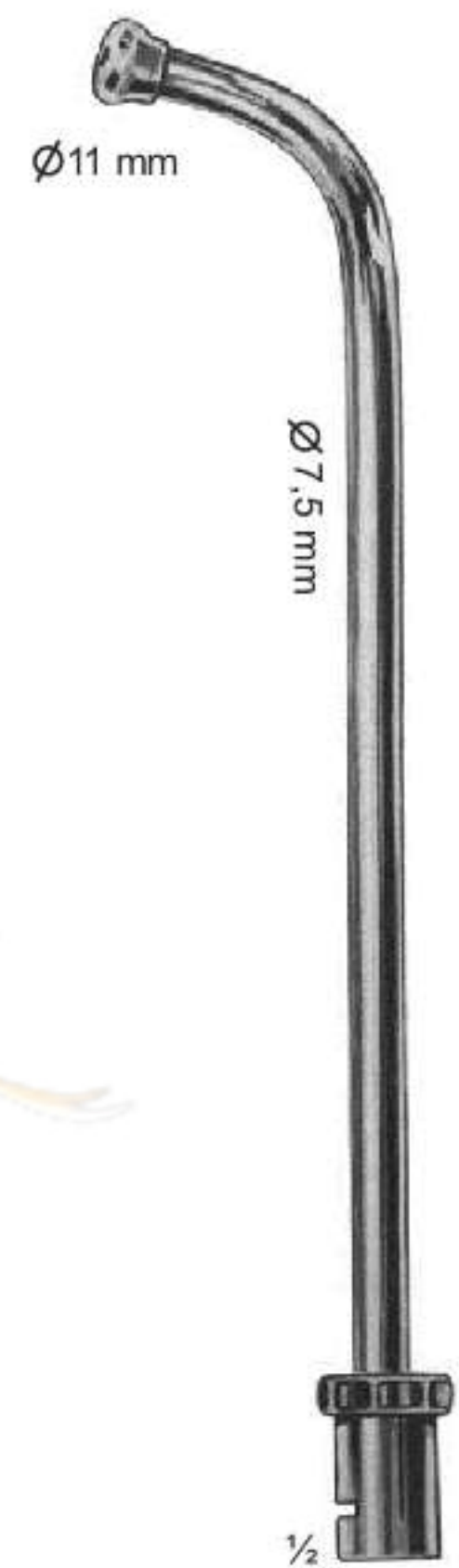

**25-119**  
For tonsillectomy,  
oral and laryngeal  
operations  
220 mm





**25-120**  
For tonsillectomy,  
oral-and laryngeal  
operations  
180 mm

**25-121**  
Suction cannula  
for tonsillectomy,  
oral-and laryngeal  
operations  
220 mm

**25-121A**  
Suction cannula  
for tonsillectomy,  
oral-and laryngeal  
operations  
180 mm

**25-122**  
S-shaped blunt cannula  
for aspirating fluid from  
the excretory ducts of  
large glands and for  
keeping the operations  
area clear  
170 mm

**25-123**  
POOL  
Suction cannula,  
with outer tube  
to be screwed of  
225 mm

**25-124**  
POOL  
Suction cannula,  
with outer tube  
to be screwed of  
225 mm

# Suction Instruments



**22-125**  
YANKAUER  
with especially large  
central bore, 4,8 mm  
diam.  
285 mm

**22-126**  
YANKAUER  
with central bore,  
2,0 mm diam.  
285 mm

**22-127**  
DE-BAKEY  
with central bore,  
3,0 mm diam. with  
lateral slots  
275 mm

**22-128**  
DE-BAKEY  
with finger cut-off  
and stylet  
270 mm

**22-129**  
DE-BAKEY  
with finger cut-off  
and stylet  
160 mm

**22-130**  
with finger  
cut-off  
190 mm

# Suction Instruments

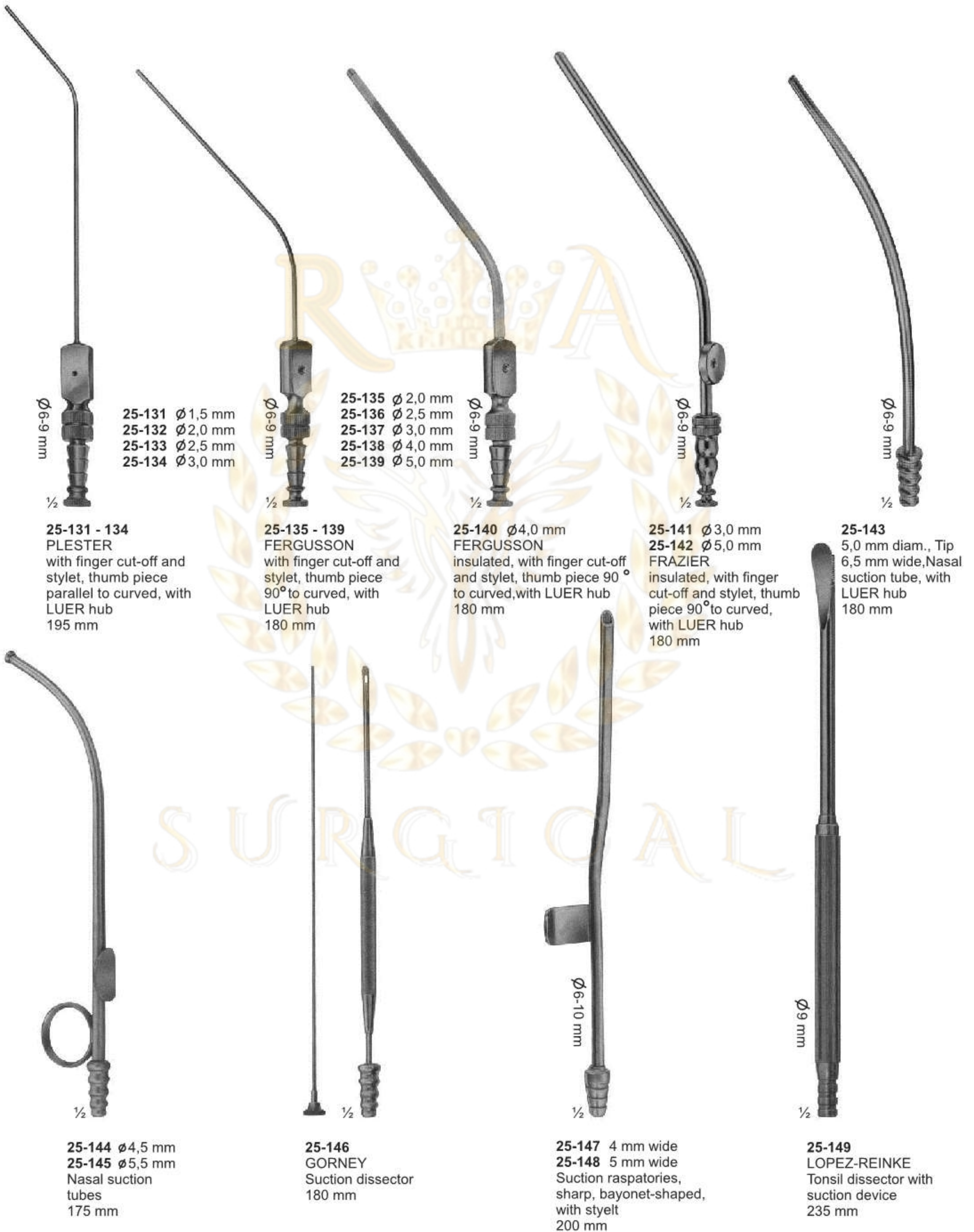

# Suction Instruments



**25-150**  
WULLSTEIN  
Suction tube, conical, silver, oliver  
with LUER hub  
160 mm

$\varnothing 1,75$  mm

$\varnothing 3$  mm  
 $\frac{1}{2}$   
 $\varnothing 8$  mm

**25-151** 1,5 mm  
**25-152** 2,0 mm  
WULLSTEIN  
Suction tube, cylindrical, silver, with  
stylet with LUER hub  
160 mm

$\frac{1}{2}$   
 $\varnothing 8$  mm

Usable length

YASARGIL usable length diam.		YASARGIL usable length diam.	
<b>25-153</b>	130 mm 1,5 mm	<b>25-161</b>	130 mm 2,5 mm
<b>25-154</b>	150 mm 1,5 mm	<b>25-162</b>	150 mm 2,5 mm
<b>25-155</b>	180 mm 1,5 mm	<b>25-163</b>	180 mm 2,5 mm
<b>25-156</b>	220 mm 1,5 mm	<b>25-164</b>	220 mm 2,5 mm
<b>25-157</b>	130 mm 2,0 mm	<b>25-165</b>	130 mm 3,5 mm
<b>25-158</b>	150 mm 2,0 mm	<b>25-166</b>	150 mm 3,5 mm
<b>25-159</b>	180 mm 2,0 mm	<b>25-167</b>	180 mm 3,5 mm
<b>25-160</b>	220 mm 2,0 mm	<b>25-168</b>	220 mm 3,5 mm
		<b>25-169</b>	180 mm 4,5 mm

$\varnothing 6,5-9$  mm  
with LUER hub

**25-170 - 172**  
LANDOLT  
150 MM  
diam  $\varnothing 3$  mm

**25-170** 8 mm / curved  
**25-171** 11mm / curved  
**25-172** 15mm / curved

$\frac{1}{2}$   
 $\frac{1}{2}$

$\varnothing 3.5$  mm

$\varnothing 2.0$  mm

**25-173** 500 mm  
**25-174** 350 mm  
with rubber tip,  
with LUER hub

$\varnothing 9$  mm  
 $\frac{1}{2}$

**25-175** 2,0 mm diam  
**25-176** 2,5 mm diam  
**25-177** 3,0 mm diam  
with finger cut-off,  
thumb piece  $90^\circ$  to  
curved, with LUER hub  
250 mm

$\varnothing 6-9$  mm  
 $\frac{1}{2}$

# Combined Suction and Irrigation Cannulae

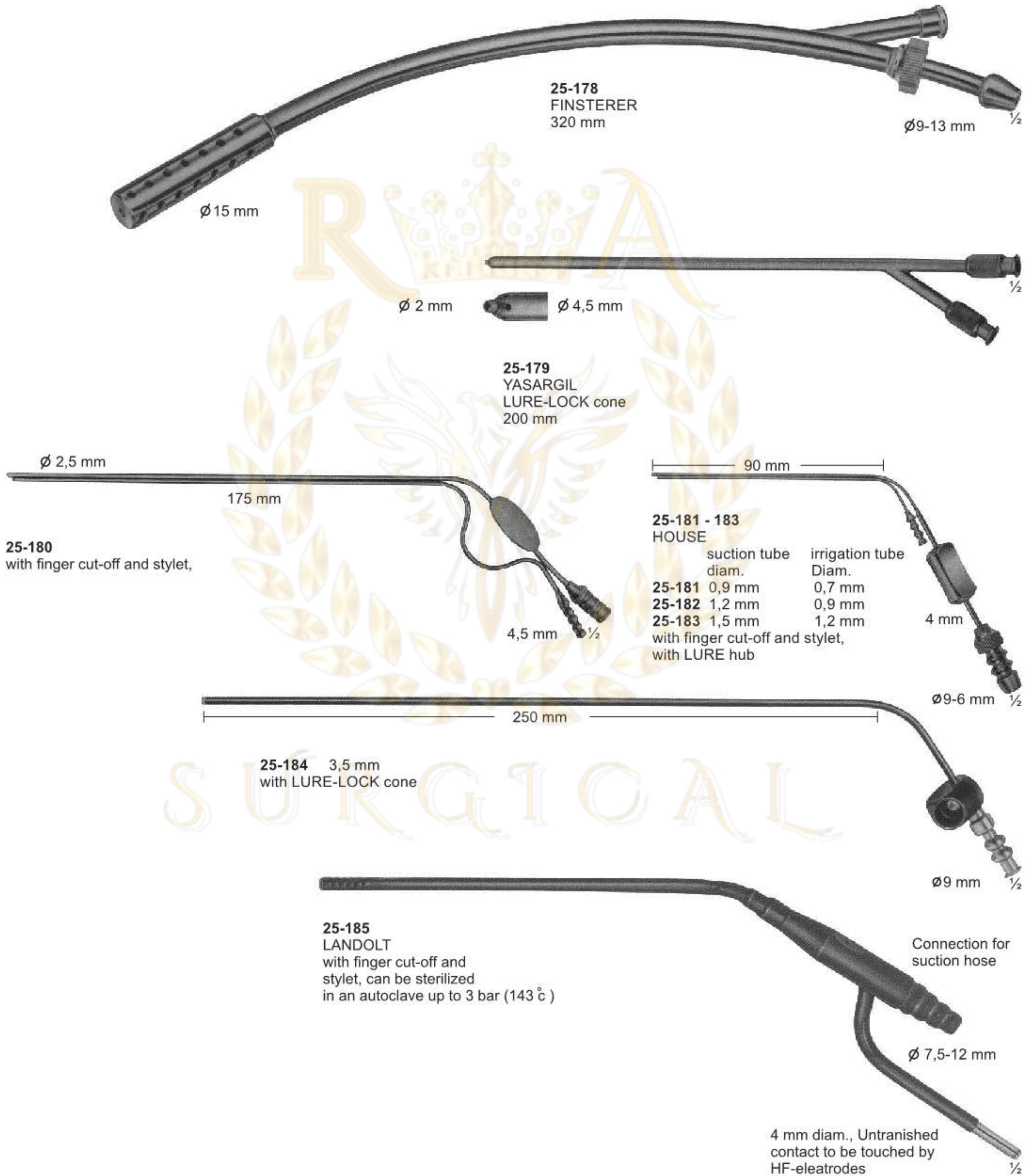

# Scissors with Tungsten Carbide Inserts



**26-101**  
Standard



14,5cm  
16,5cm  
18,5cm



**26-102**  
Standard



14,5cm  
16,5cm  
18,5cm



**26-103**  
Standard

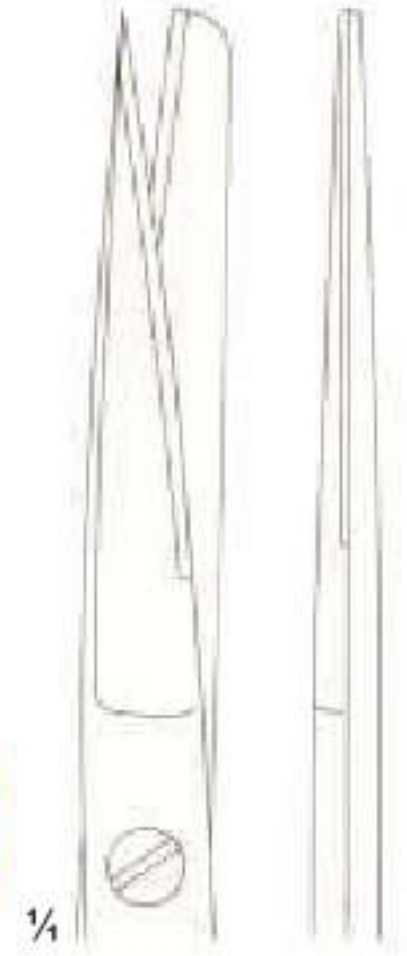

14,5cm  
16,5cm  
18,5cm



**26-104**  
Standard

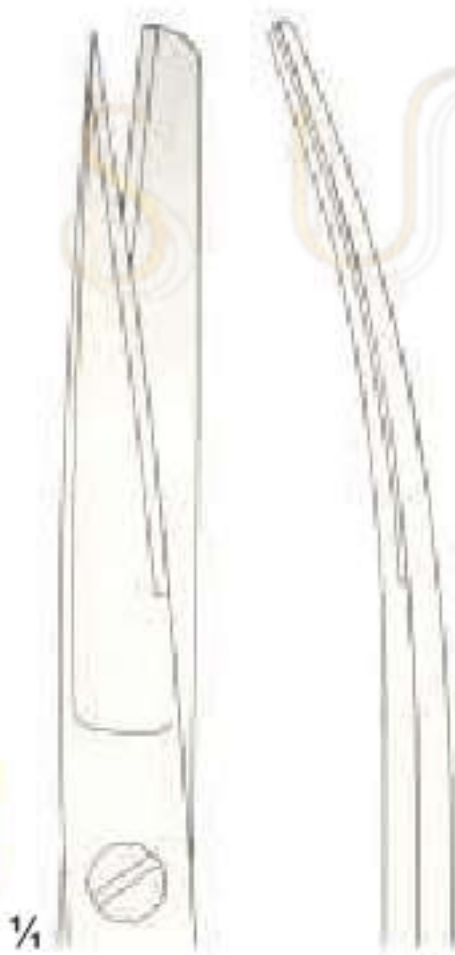

14,5cm  
16,5cm  
18,5cm



**26-105**  
Standard

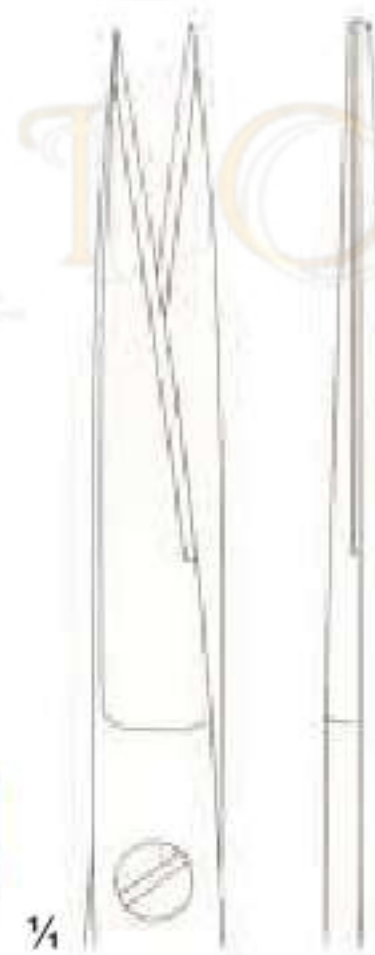

14,5cm  
16,5cm  
18,5cm



**26-106**  
Standard

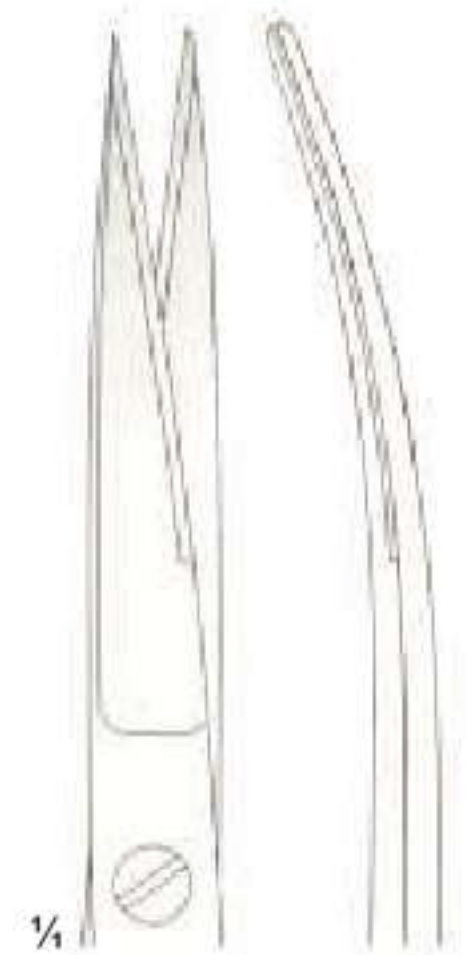

14,5cm  
16,5cm  
18,5cm

# Scissors with Tungsten Carbide Inserts

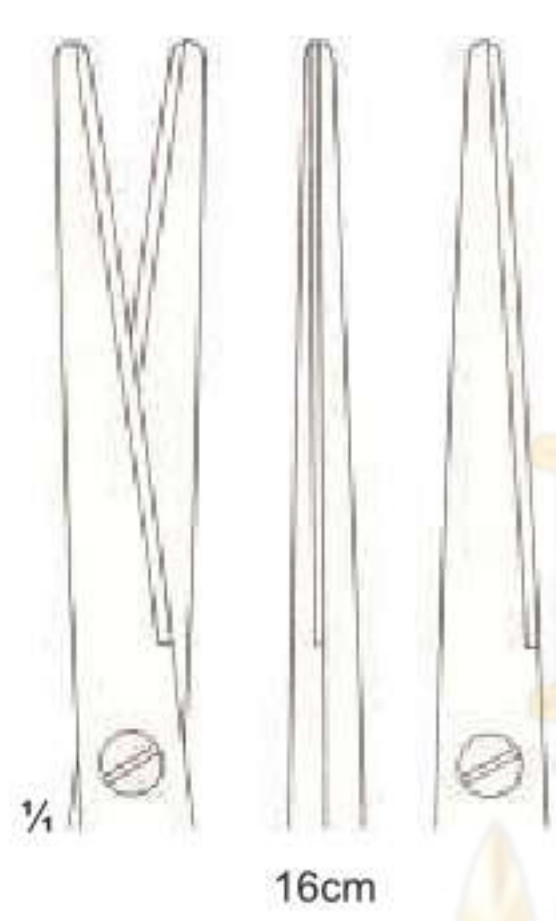

16cm



16cm

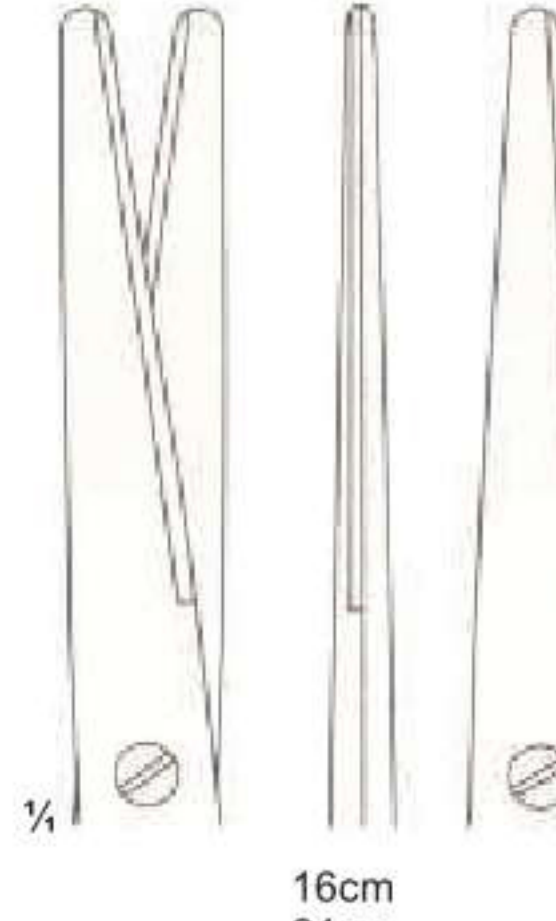

16cm  
21cm



16cm  
21cm

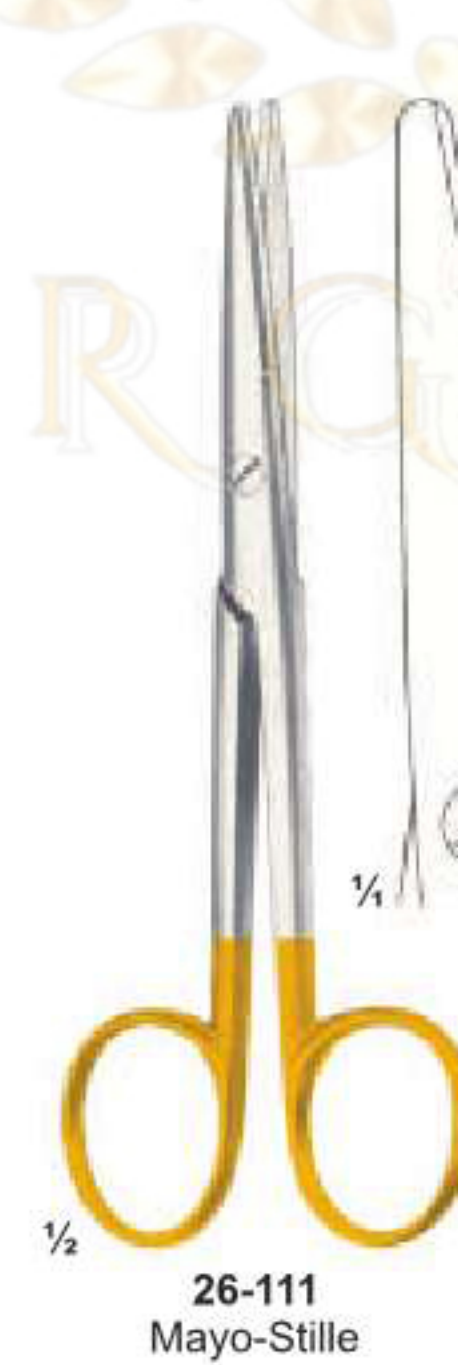

15cm  
17cm

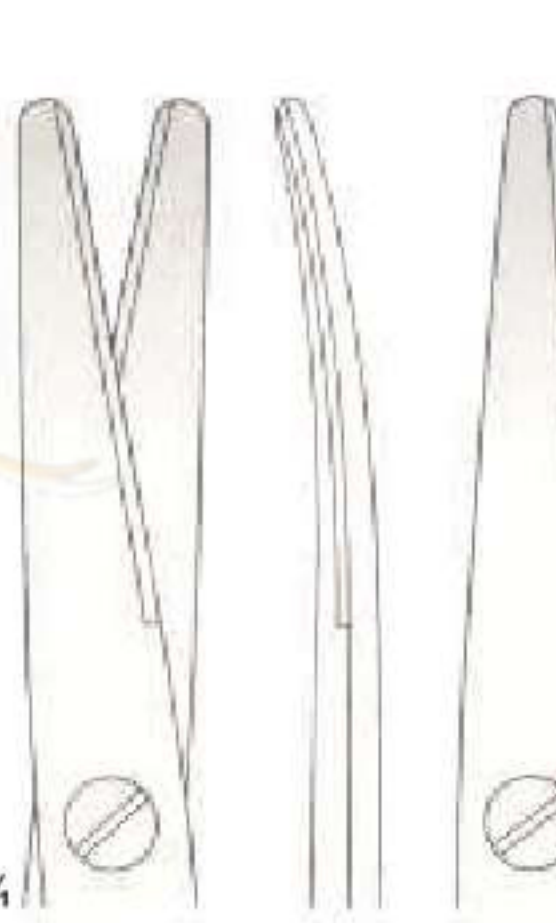
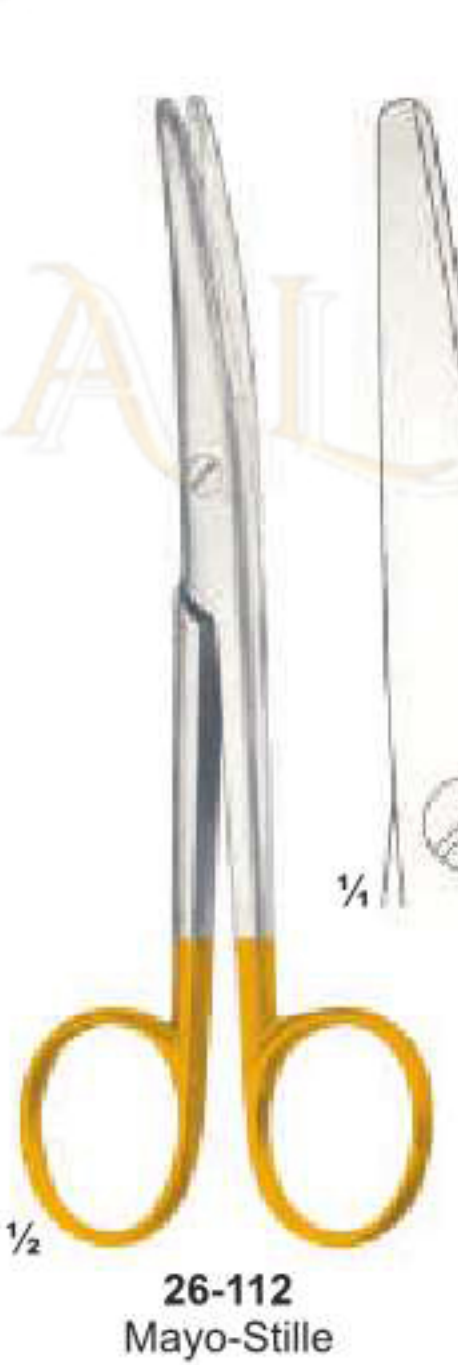

15cm  
17cm

# Scissors with Tungsten Carbide Inserts

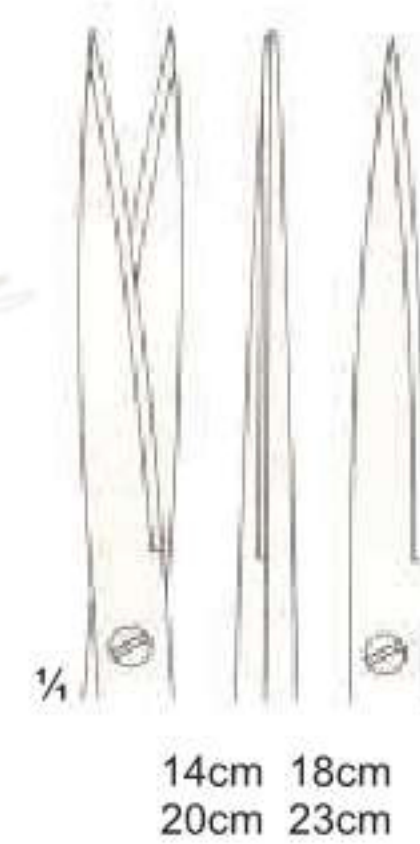
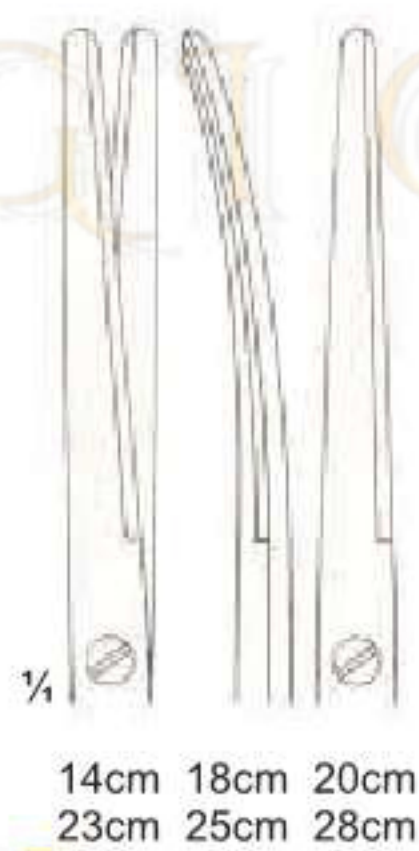
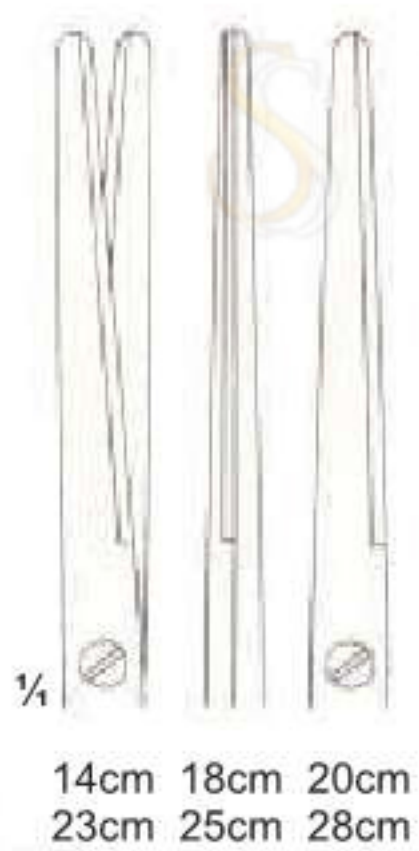
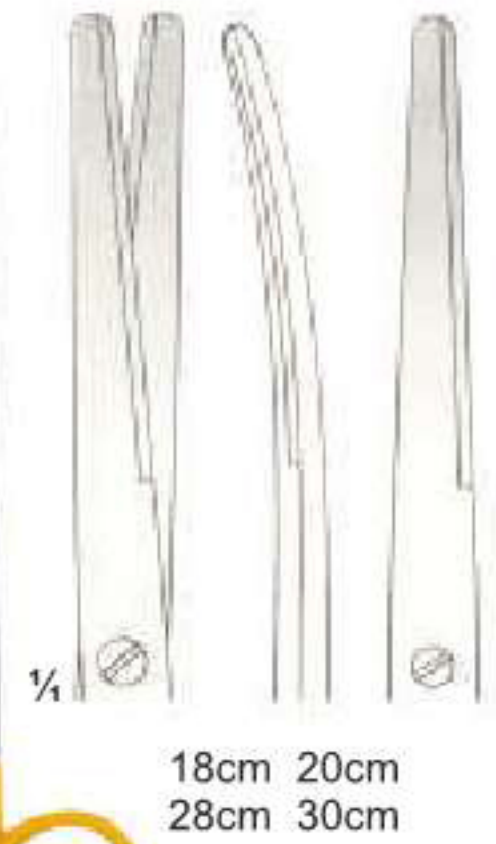
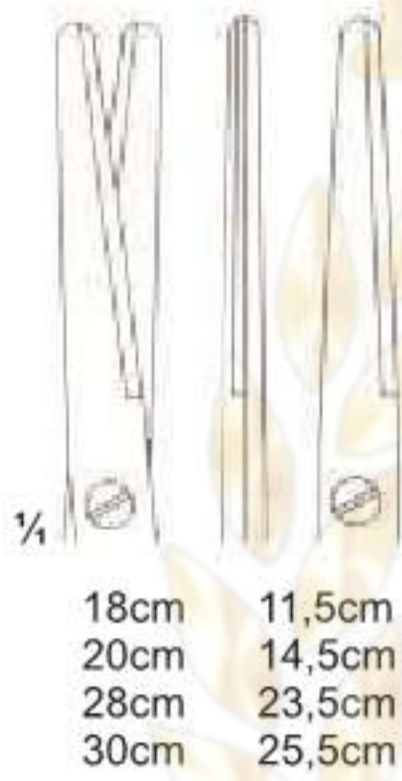



# Scissors with Tungsten Carbide Inserts



# Scissors with Tungsten Carbide Inserts

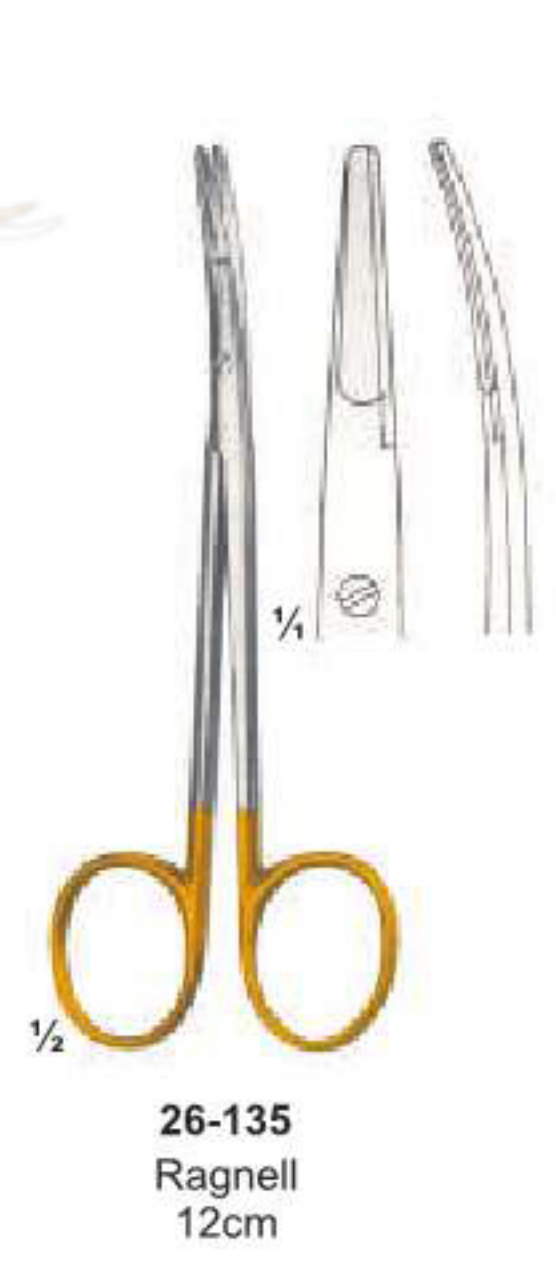

# Scissors & Dissecting Forceps with Tungsten Carbide Inserts

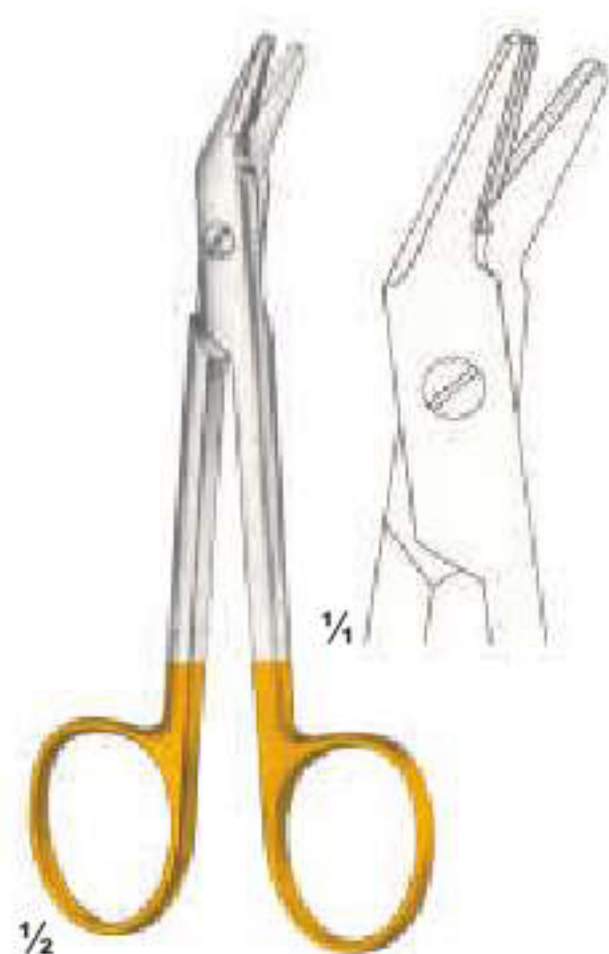

**26-136**  
Universal  
12cm



**26-137**  
Ligature Scissors  
1 Black & 1 Goldplated ring



**26-138**  
Adson



**26-139**  
Cushing  
17,5cm



**26-140**  
Cushing  
18cm



**26-141**  
Cushing-Taylor  
18cm



**26-142**  
Dissecting Forceps  
15cm



**26-143**  
Semken  
15cm

# Dissecting Forceps and Needle holders with Tungsten Carbide Inserts



SURGICAL



# Needle holders with Tungsten Carbide Inserts



**26-152**  
Arruga  
16cm

**26-153**  
Castroviejo  
13cm

**26-154**  
Hegar  
20cm 24cm

**26-155**  
Halsey  
13cm 15cm

**26-156**  
Mayo-Hegar  
16cm 18cm 20cm  
24cm 26cm 30cm

**26-157**  
De-Bakey  
18cm 20cm 23cm  
26cm 31cm 37cm

**26-158**  
Hegar-Vascular  
14cm 18cm  
20cm 23cm

# Needle holders with Tungsten Carbide Inserts



$\frac{1}{2}$   
**26-159**  
Bozemann-Wertheim  
20cm 24cm 26cm



$\frac{1}{2}$   
**26-160**  
Stratte  
22cm 23cm

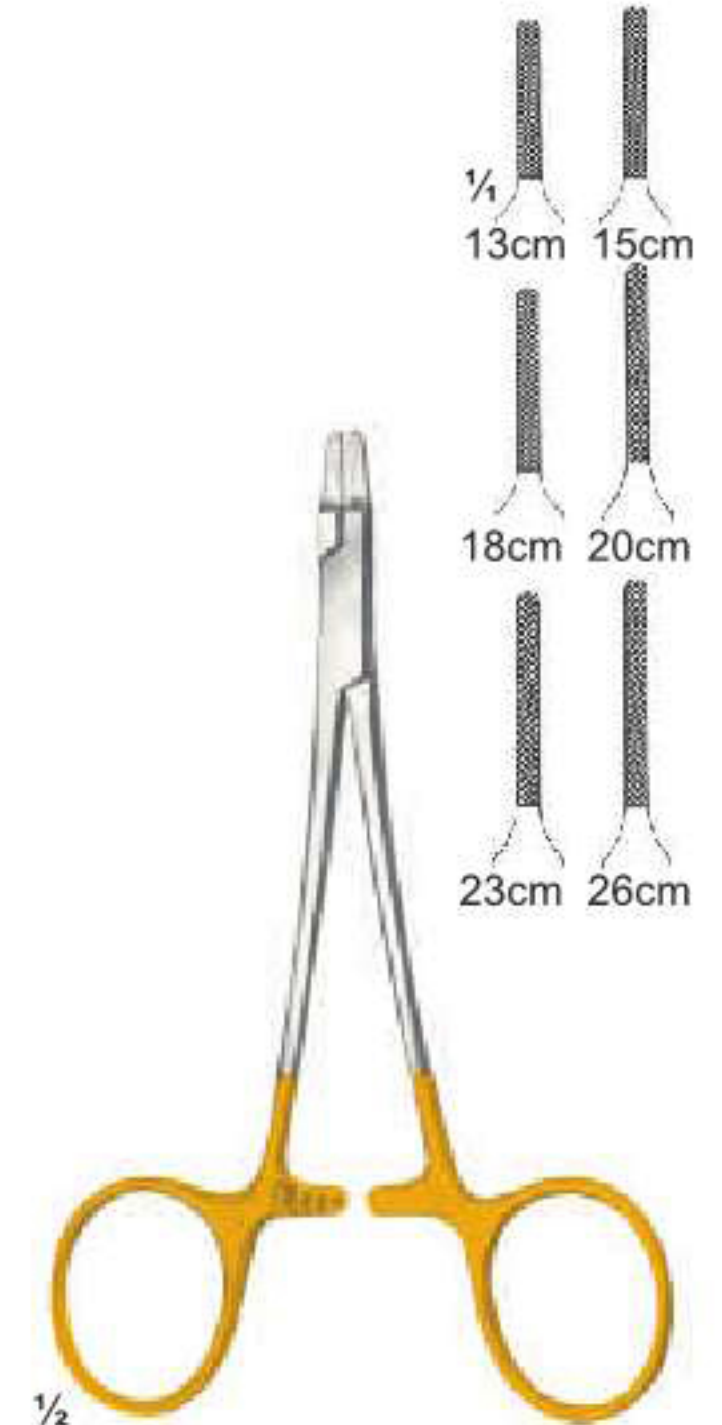

$\frac{1}{2}$   
**26-161**  
Ryder  
13cm 15cm 18cm  
20cm 23cm 26cm



$\frac{1}{2}$   
**26-162**  
Ryder-Vascular  
13cm 15cm 18cm  
20cm 23cm 26cm



$\frac{1}{2}$   
**26-163**  
Martin  
15cm 17cm 20cm



$\frac{1}{2}$   
**26-164**  
Sarot  
18cm 20cm 26cm

# Needle holders with Tungsten Carbide Inserts



# Needle holders with Tungsten Carbide Inserts



SURGICAL

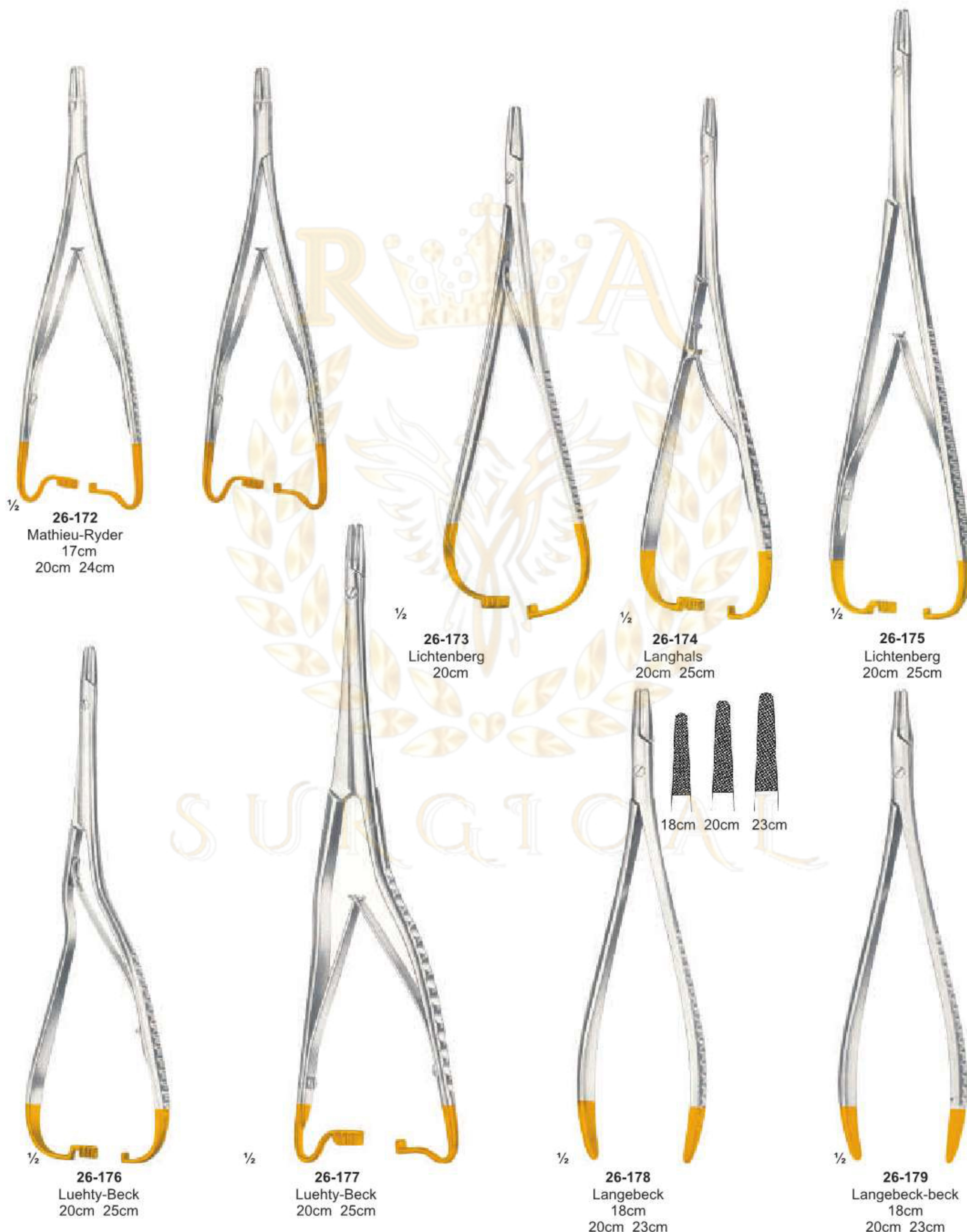

1/2  
**26-172**  
Mathieu-Ryder  
17cm  
20cm 24cm

1/2  
**26-173**  
Lichtenberg  
20cm

1/2  
**26-174**  
Langhals  
20cm 25cm

1/2  
**26-175**  
Lichtenberg  
20cm 25cm

18cm 20cm 23cm

1/2  
**26-176**  
Luehty-Beck  
20cm 25cm

1/2  
**26-177**  
Luehty-Beck  
20cm 25cm

1/2  
**26-178**  
Langebeck  
18cm  
20cm 23cm

1/2  
**26-179**  
Langebeck-beck  
18cm  
20cm 23cm



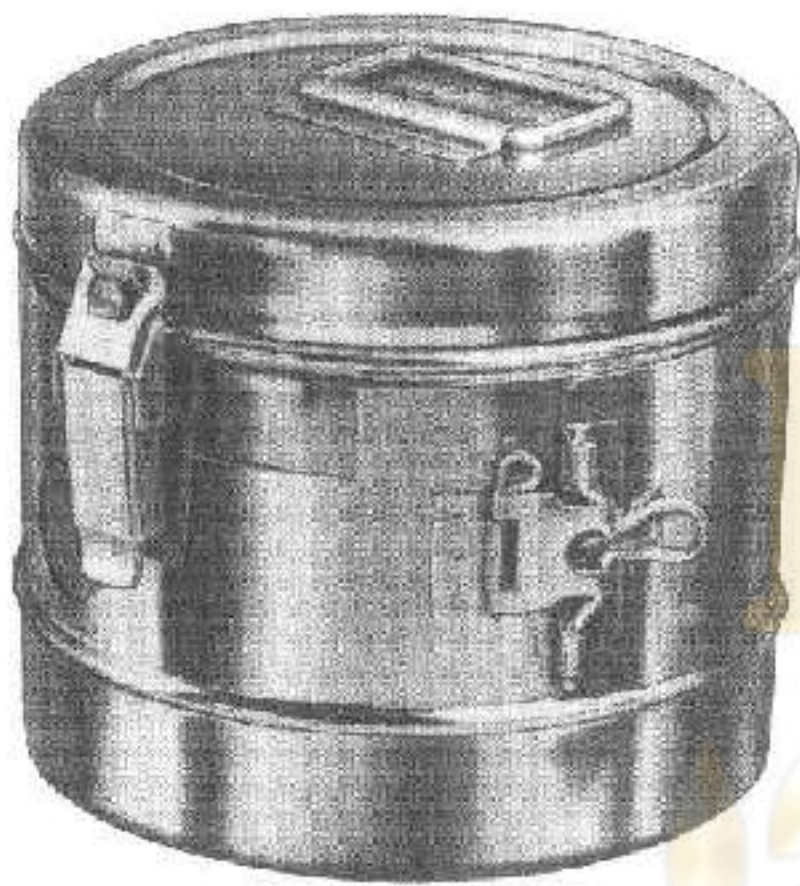

**27-101 - 115**  
Schimmelbusch

	Ø x H sizes in mm
<b>27-101</b>	80 x 80
<b>27-102</b>	105 x 120
<b>27-103</b>	140 x 140
<b>27-104</b>	160 x 120
<b>27-105</b>	160 x 150
<b>27-106</b>	190 x 150
<b>27-107</b>	190 x 190
<b>27-108</b>	240 x 160
<b>27-109</b>	240 x 240
<b>27-110</b>	290 x 160
<b>27-111</b>	290 x 240
<b>27-112</b>	340 x 160
<b>27-113</b>	340 x 340

**27-114** 390 x 190  
**27-115** 390 x 290

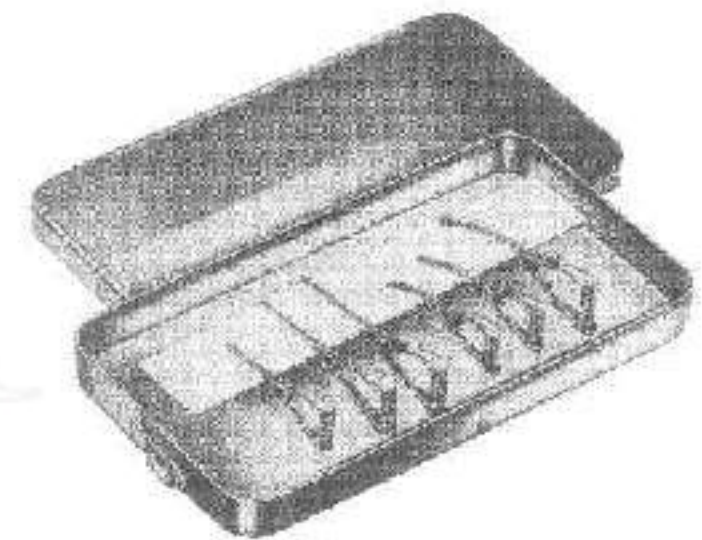

**27-116**  
Box  
120 x 65 x 13mm  
(without Bulldog clamps,  
without silicone tape)



**27-117**  
Box with support  
120 x 65 x 13 mm  
(ohne Bulldogklemmen)



**27-118**  
Box with support for  
needle electrodes,  
without instruments

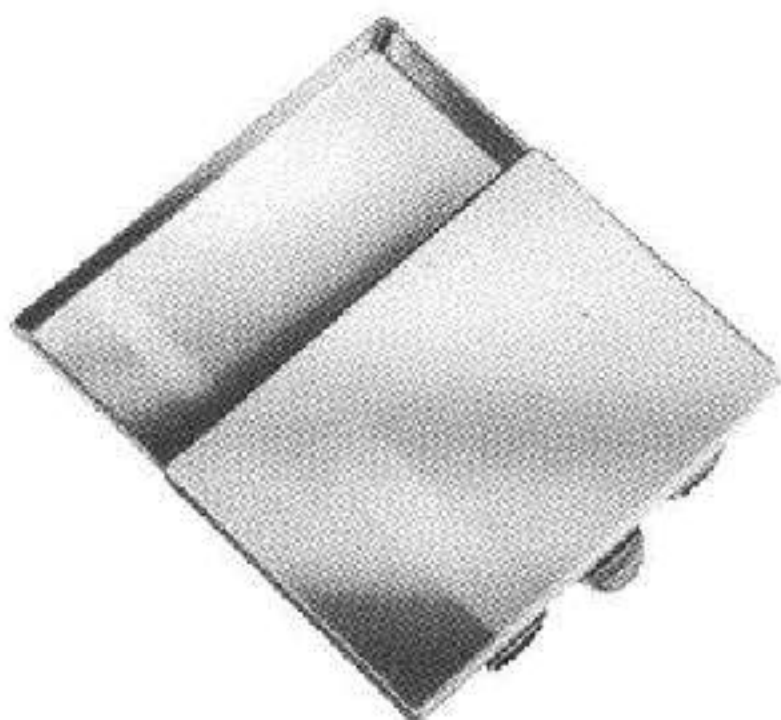

**27-119 - 121**  
50 x 25 x 4,5 mm  
**27-120**  
65 x 42 x 8 mm  
**27-121**  
75 x 25 x 4,5 mm

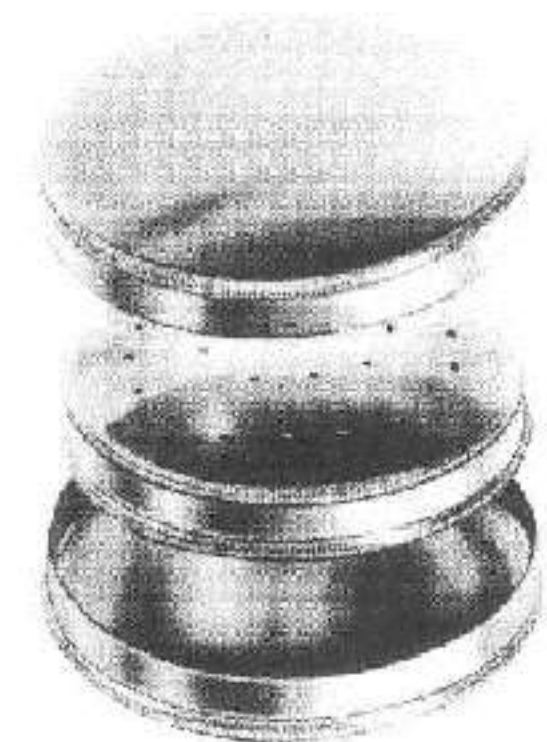

**27-122**  
Ø 65mm x 15mm



27-123 - 131

	Ø x H
27-123	30 x 90 mm
27-124	50 x 100 mm
27-125	50 x 130 mm
27-126	50 x 175 mm
27-127	75 x 100 mm
27-128	75 x 130 mm
27-129	75 x 175 mm
27-130	100 x 175 mm
27-131	100 x 200 mm



27-132 - 139

27-132	165 x 85 x 35	mm
27-133	200 x 100 x 35	mm
27-134	200 x 100 x 50	mm
27-135	230 x 130 x 50	mm
27-136	260 x 150 x 50	mm
27-137	270 x 235 x 50	mm
27-138	300 x 200 x 50	mm
27-139	325 x 275 x 50	mm

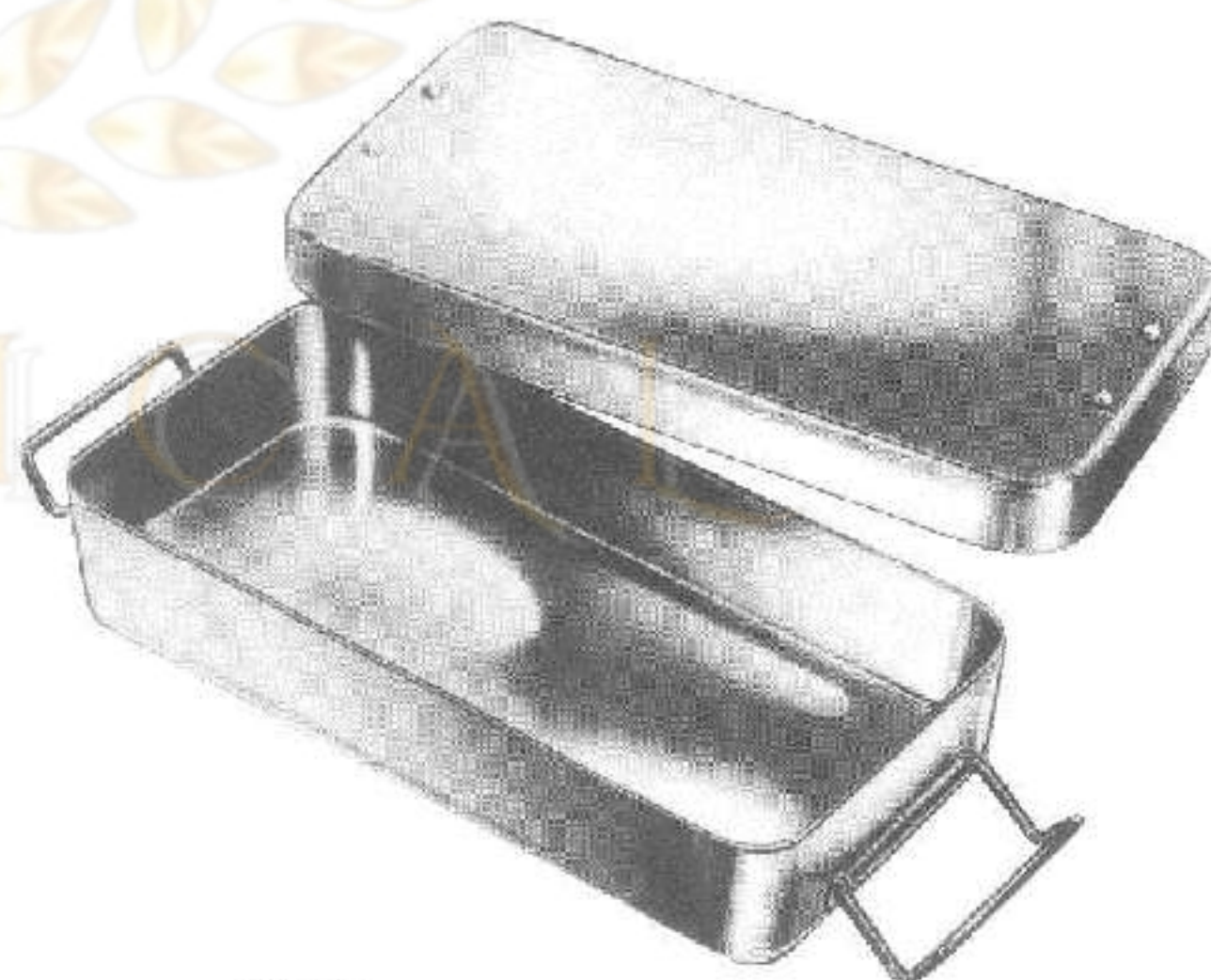

27-140  
205 x 105 x 35 mm



**27-141 - 142**

- 27-141** | Martin Sterilizing Forceps  
consisting of:  
1 Sterilizing Forceps, curved, 25 cm,  
without ratchet, with lid for jar  
1 jar with bottom plate (anti-tilt)
- 27-142** | ditto, with 32 cm long Sterilizing Forceps

# Round Metal Boxes and Medicine Cups

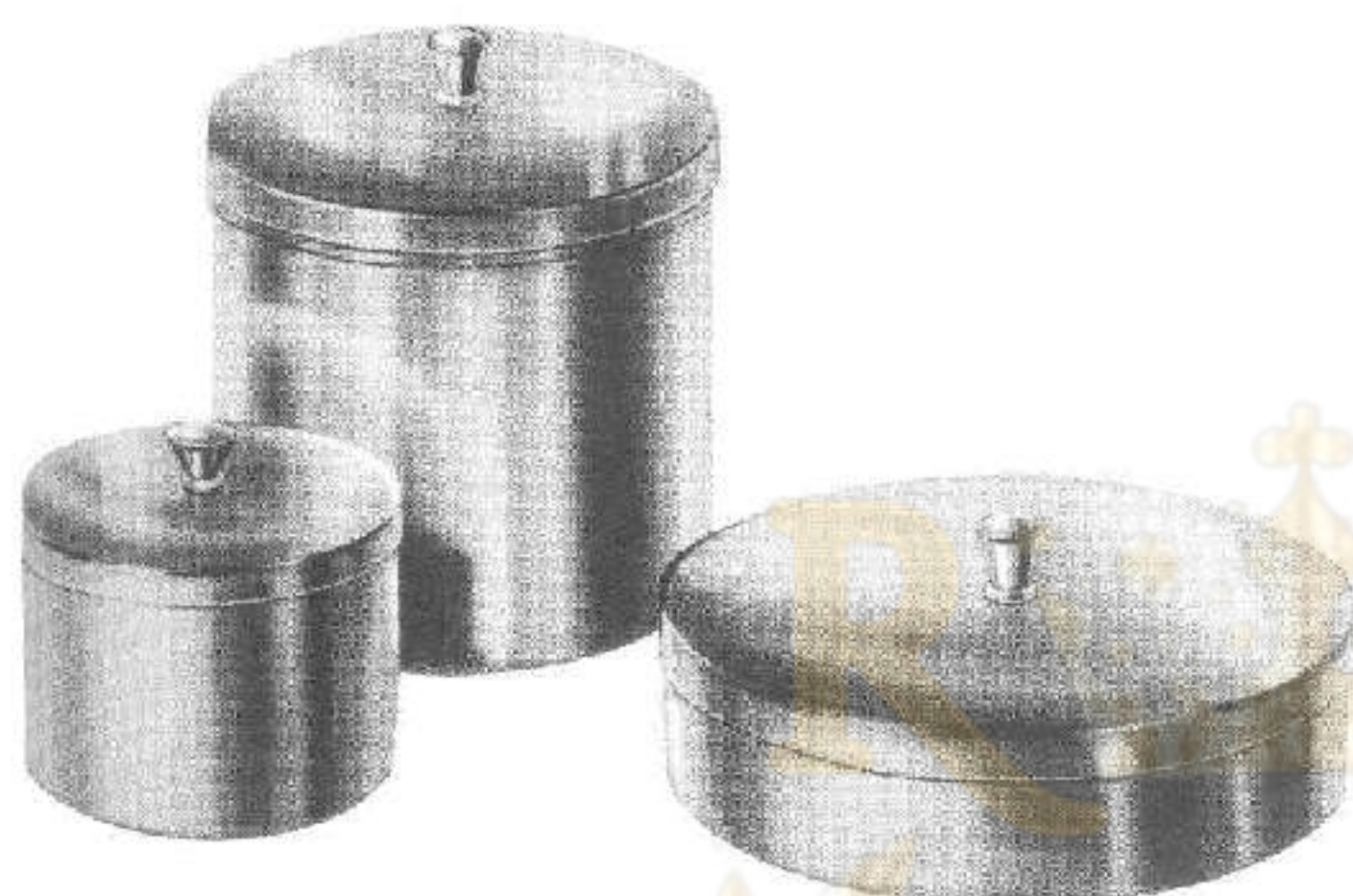

27-143 - 148

	Ø x H
27-143	75 x 60 mm
27-144	75 x 75 mm
27-145	100 x 60 mm
27-146	100 x 100 mm
27-146A	125 x 80 mm
27-147	125 x 125 mm
27-148	150 x 150 mm



27-149  
25 cc

27-150  
50 cc



27-151  
20 cc  
Medicine Spoon

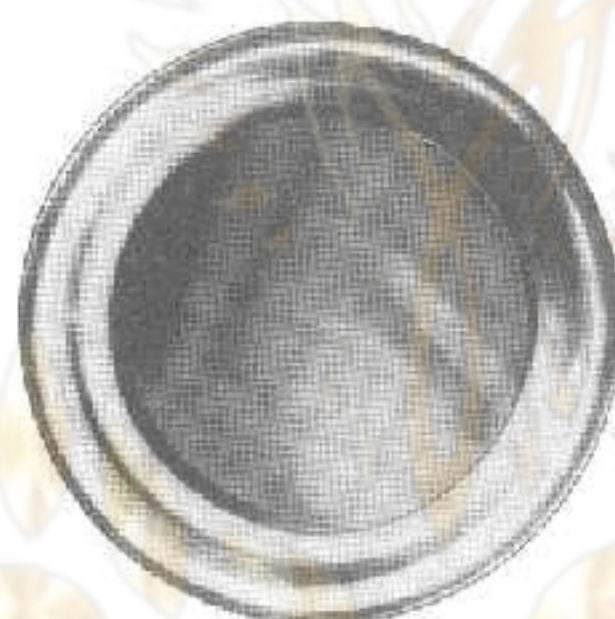

27-152  
Ø75 x 12 mm  
Tablet Tray



27-153  
Ø90 x 90 mm  
Metal Cup



27-154  
Ø75 x 80 mm  
Sputum Cup

SURGICAL

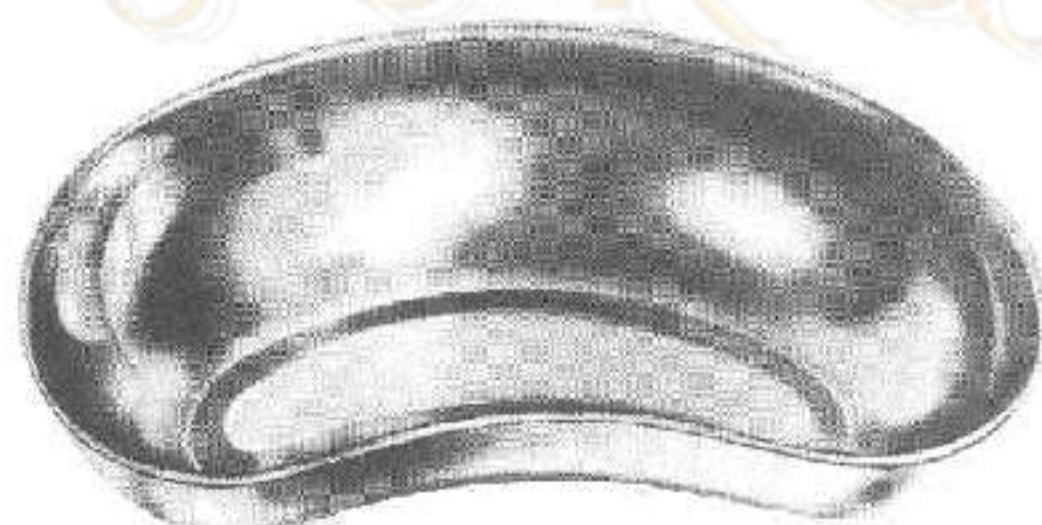

Kidney Dish

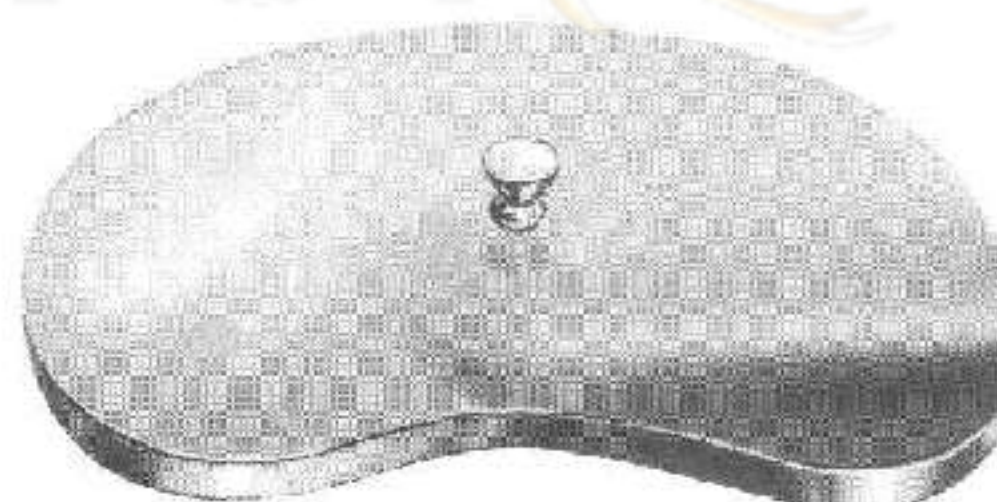

27-155 - 157

27-155	170 x 100 x 35 mm
27-156	250 x 140 x 40 mm
27-157	275 x 150 x 45 mm



27-158 - 165

	Ø x H	
27-158	40 x 19 mm	0.05L
27-159	61 x 30 mm	0.07L
27-160	80 x 40 mm	0.14L
27-161	116 x 50 mm	0.35L
27-162	128 x 55 mm	0.45L
27-163	147 x 65 mm	0.70L
27-164	167 x 75 mm	1.10L
27-165	187 x 85 mm	1.60L



27-166 - 170

27-166	116 x 35 mm	0.30L
27-167	128 x 38 mm	0.40L
27-168	147 x 40 mm	0.50L
27-169	157 x 45 mm	0.75L
27-170	187 x 45 mm	1.00L

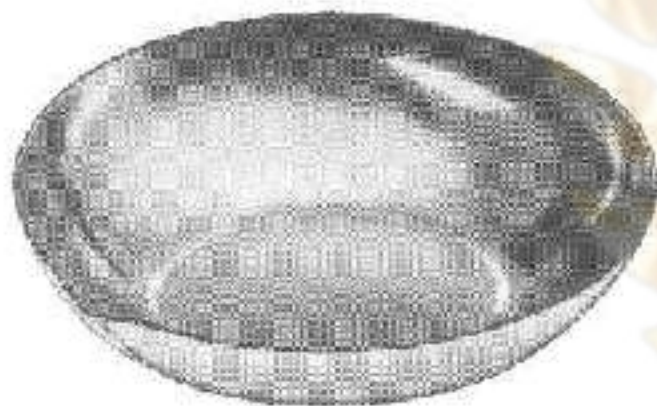

27-171  
Ø 110 x 28 mm 0.15L



27-172  
100 cc 0.1L



27-173 - 176  
27-173 0,25L  
27-174 0,50L  
27-175 1,00L  
27-176 2,00L



27-177  
235 x 190 x 40 mm



27-178  
Ø 220 x 70 mm

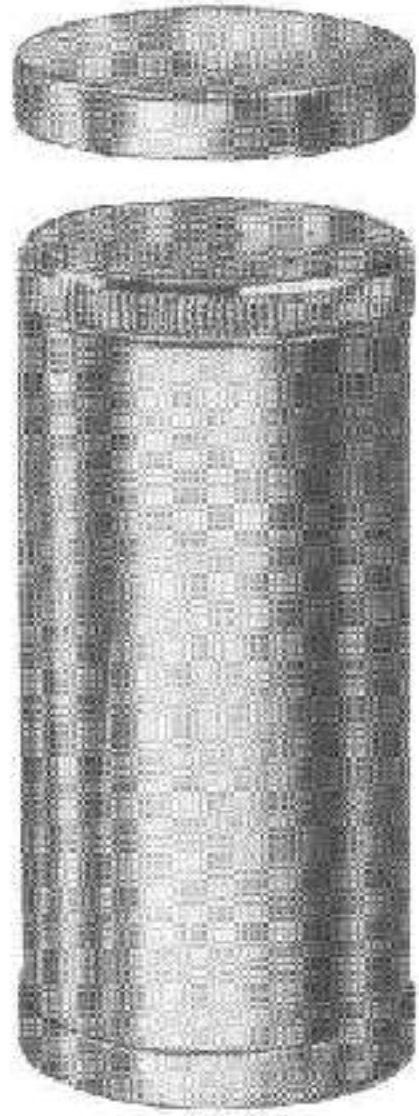

27-179  
 $\phi$  50 x 100 mm  
 Powder Pot



27-180  
 $\phi$  50 x 75 mm  
 Methot With Lid



27-181  
 $\phi$  50 x 75 mm  
 Methot Without Lid



27-182



27-183

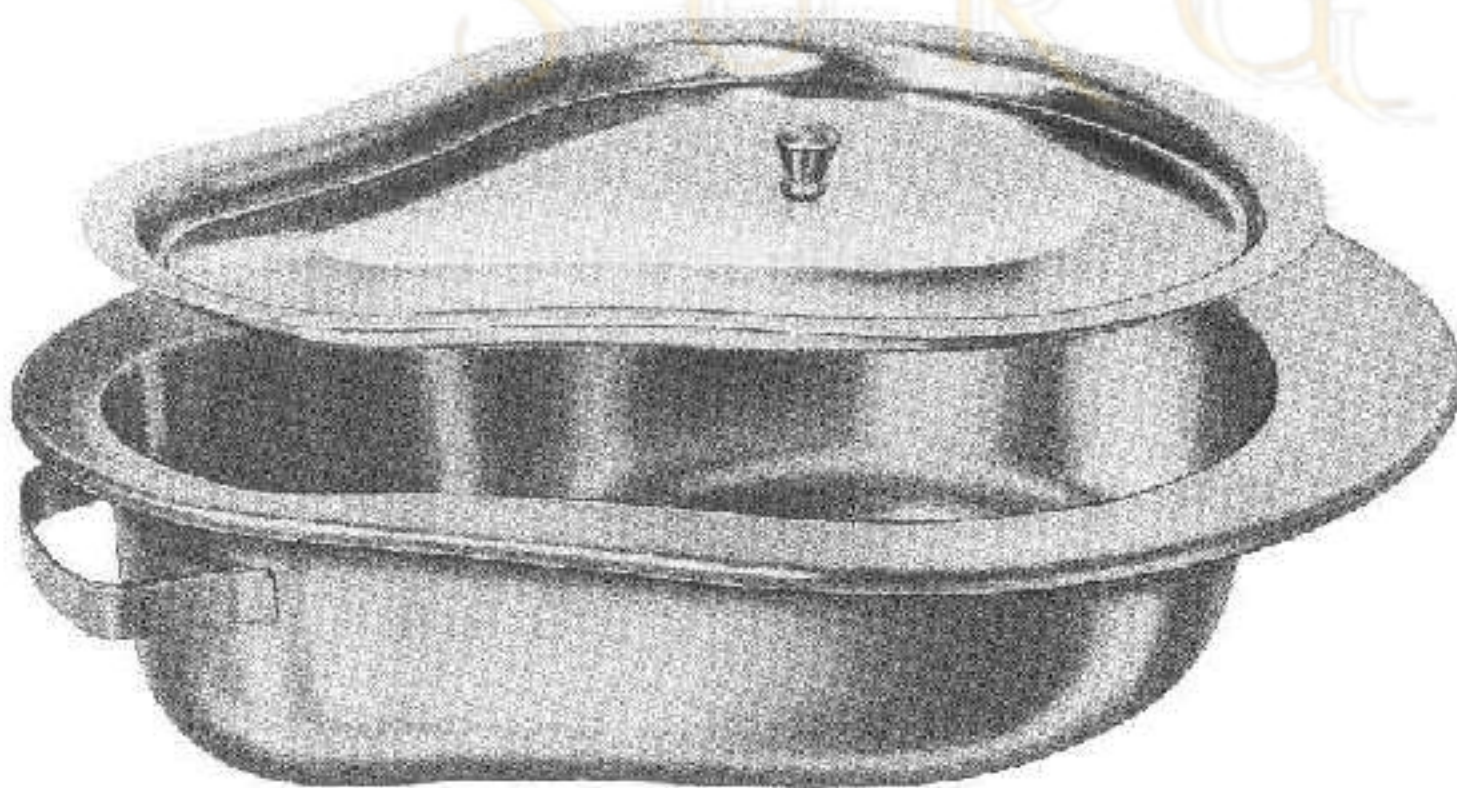

27-184

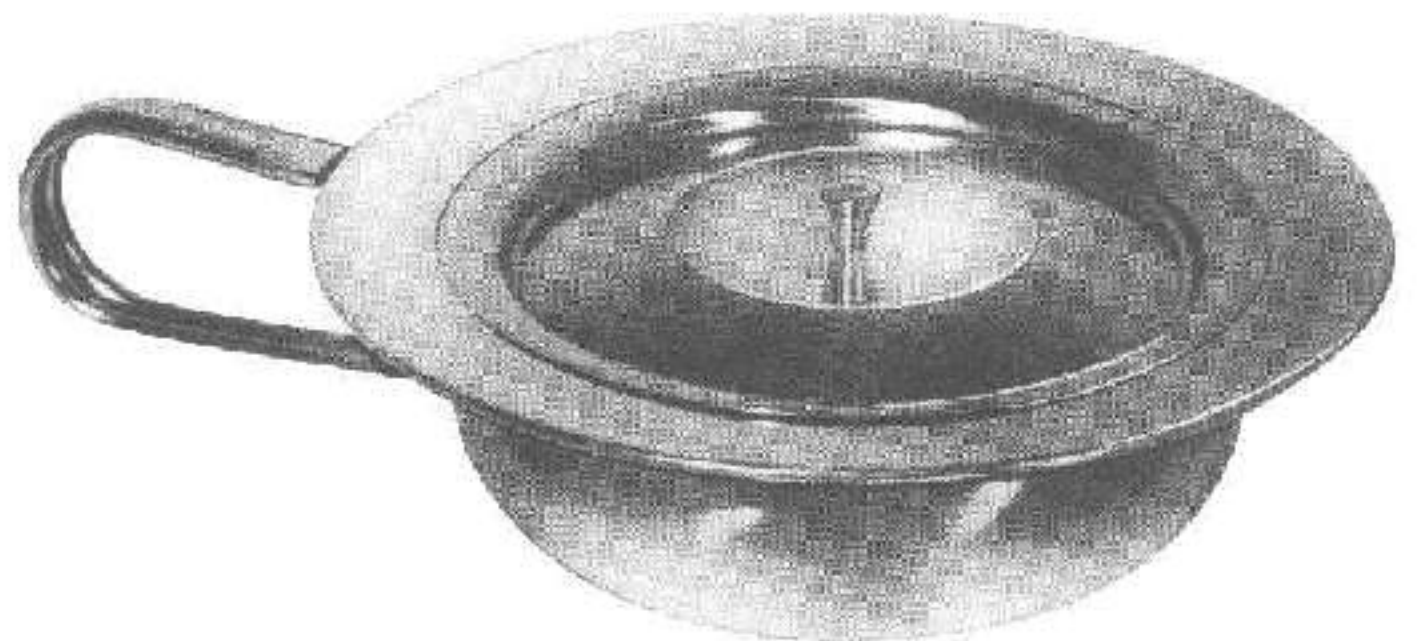

27-185 - 186

27-185  $\phi$  235 mm  
 27-186  $\phi$  310 mm

# Needle Cases



**27-187**  
Sauerbruch  
210 x 125 x 17 mm



**27-188**  
Sauerbruch  
210 x 125 x 17 mm



**27-189**  
150 x 95 x 13 mm



**27-190**  
150 x 95 x 13 mm



**27-191**  
150 x 95 x 13 mm



**27-192**  
150 x 95 x 13 mm

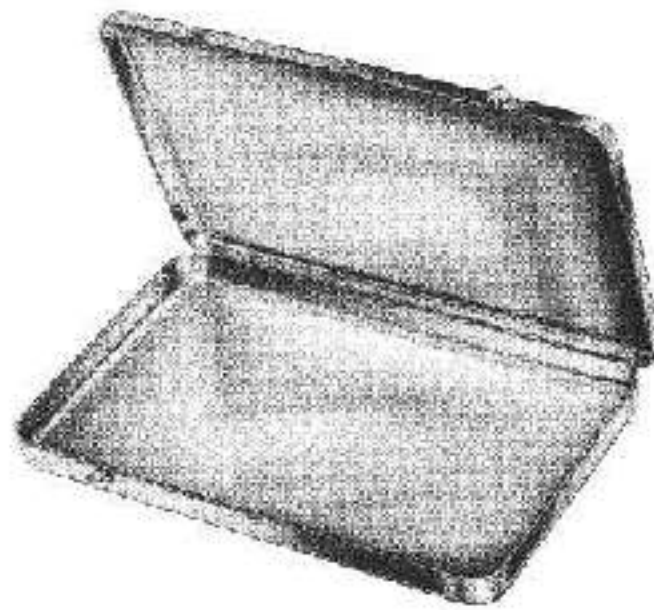

**27-193**  
150 x 95 x 13 mm

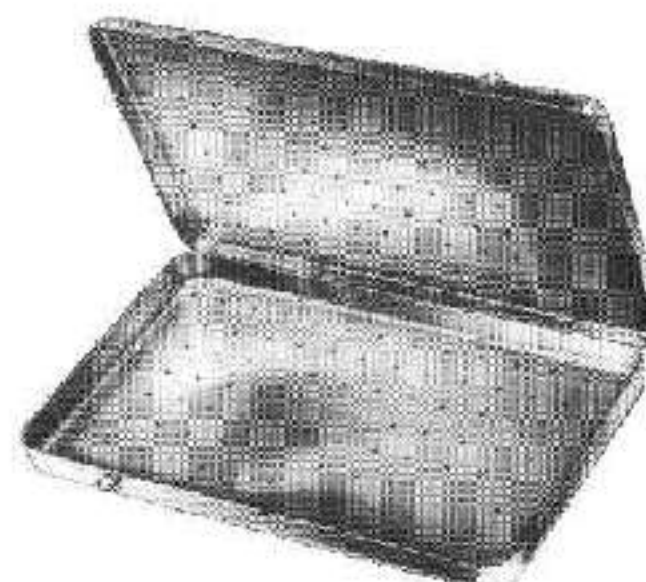

**27-194**  
150 x 95 x 13 mm

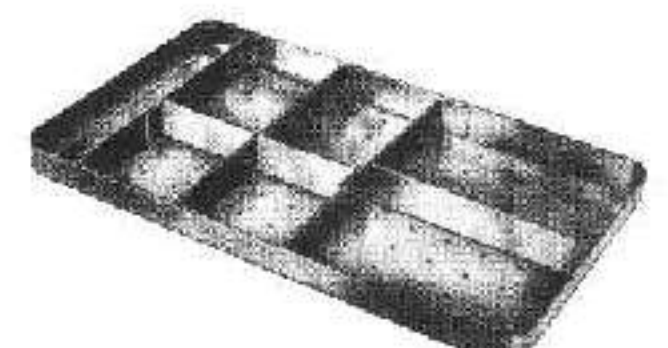

**27-195**  
150 x 95 x 11 mm

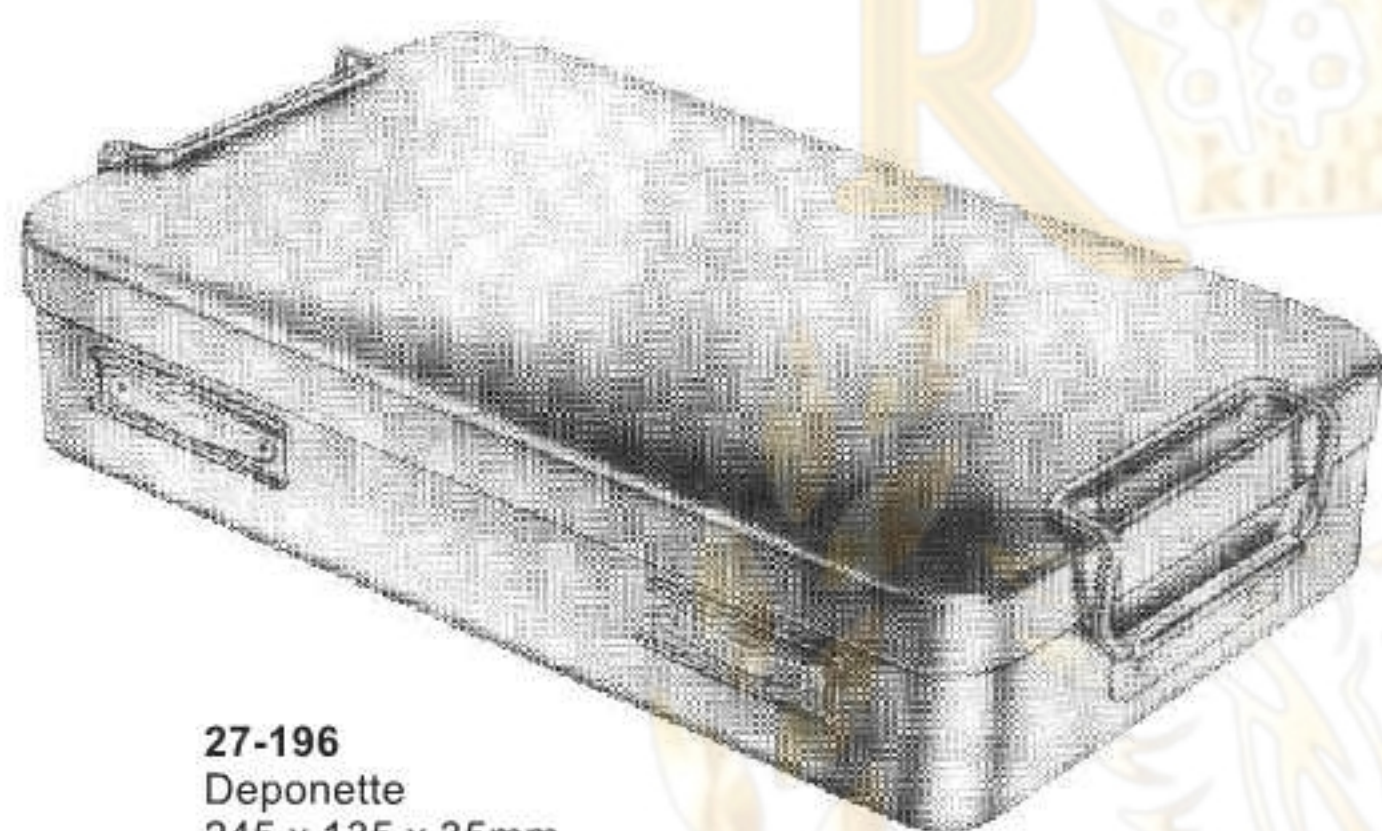

**27-196**  
Deponette  
245 x 135 x 35mm

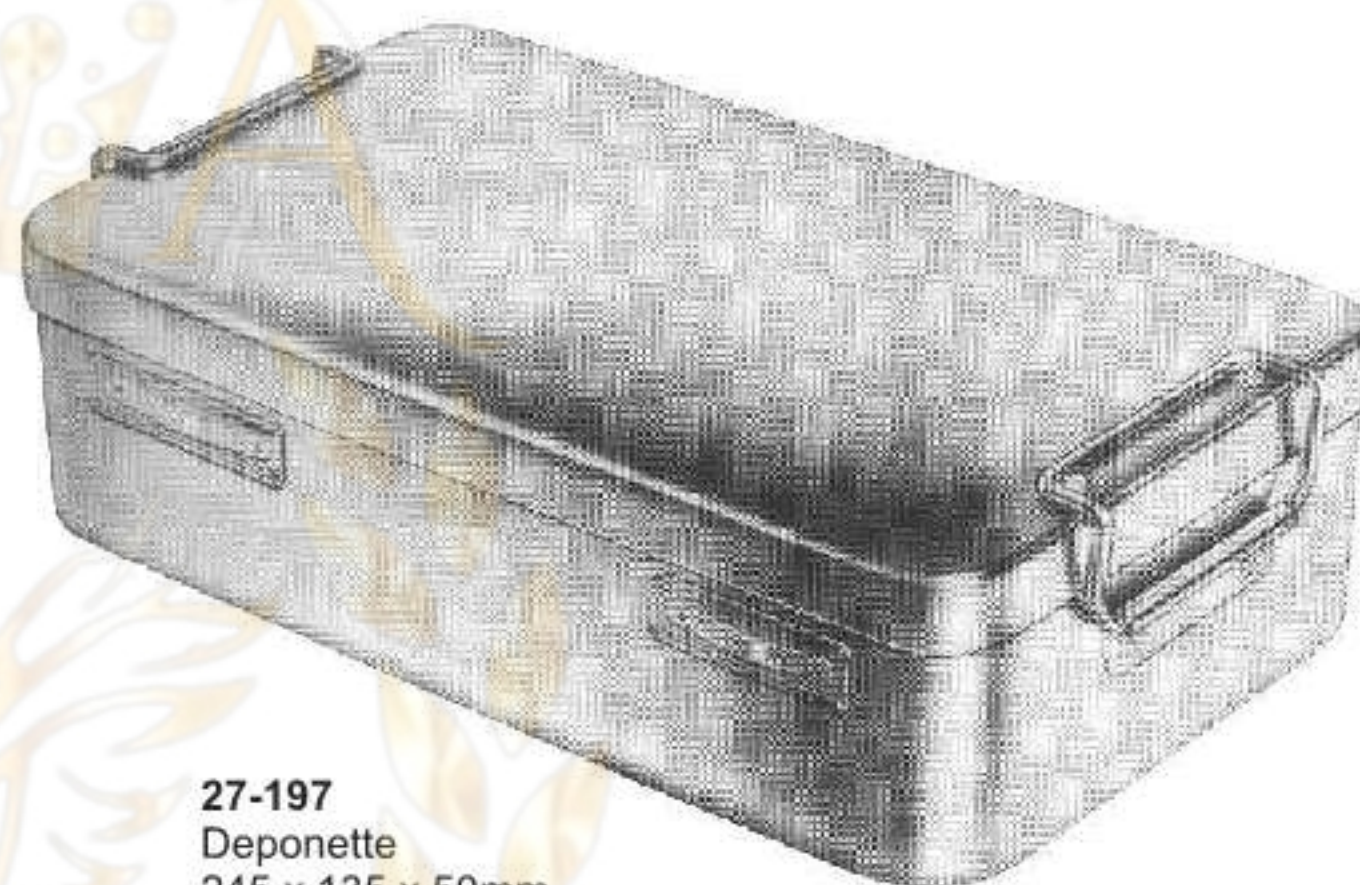

**27-197**  
Deponette  
245 x 135 x 50mm



**27-198**  
Deponette  
245 x 135 x 60mm



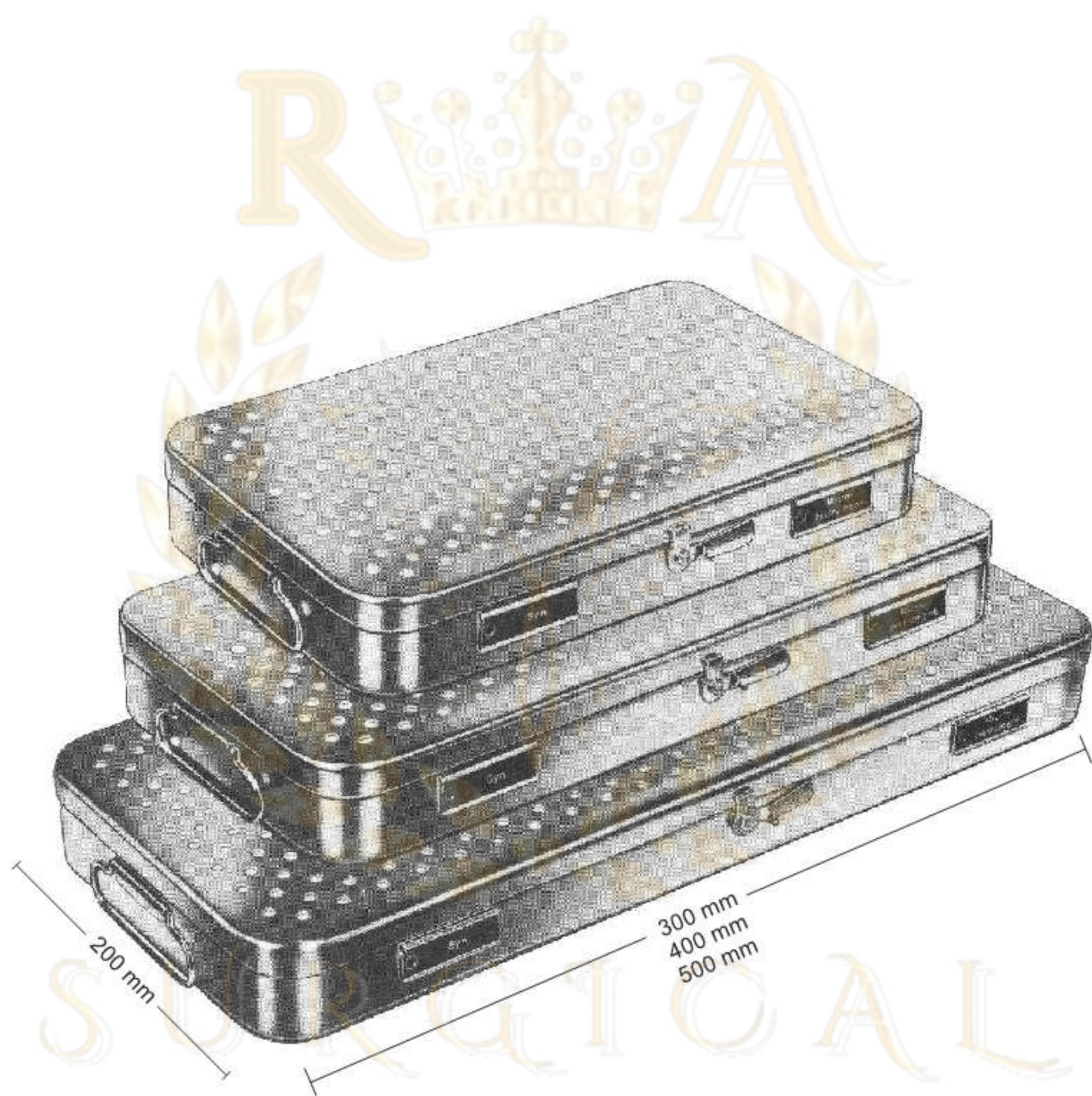

27-199 - 209

27-199	230 x 130 x 50	mm
27-200	260 x 150 x 50	mm
27-201	275 x 235 x 50	mm
27-202	300 x 200 x 50	mm
27-203	325 x 275 x 50	mm
27-204	420 x 175 x 50	mm
27-205	230 x 130 x 75	mm
27-206	260 x 150 x 75	mm
27-207	300 x 200 x 75	mm
27-208	325 x 275 x 75	mm
27-209	420 x 175 x 75	mm

# Sterilizing Baskets / Trays



27-210 - 212

27-210	480 x 250 x 50	mm
27-211	520 x 250 x 75	mm
27-212	520 x 250 x 100	mm



27-213 - 218

27-213	240 x 240 x 50	mm
27-214	240 x 240 x 80	mm
27-215	240 x 240 x 100	mm
27-216	480 x 260 x 50	mm
27-217	520 x 260 x 80	mm
27-218	520 x 260 x 100	mm